

Content Matrix 9.11
Public Folder Edition



© 2025 Quest Software Inc. ALL RIGHTS RESERVED.

This guide contains proprietary information protected by copyright. The software described in this guide is furnished under a software license or nondisclosure agreement. This software may be used or copied only in accordance with the terms of the applicable agreement. No part of this guide may be reproduced or transmitted in any form or by any means, electronic or mechanical, including photocopying and recording for any purpose other than the purchaser's personal use without the written permission of Quest Software Inc.

The information in this document is provided in connection with Quest Software products. No license, express or implied, by estoppel or otherwise, to any intellectual property right is granted by this document or in connection with the sale of Quest Software products. EXCEPT AS SET FORTH IN THE TERMS AND CONDITIONS AS SPECIFIED IN THE LICENSE AGREEMENT FOR THIS PRODUCT, QUEST SOFTWARE ASSUMES NO LIABILITY WHATSOEVER AND DISCLAIMS ANY EXPRESS, IMPLIED OR STATUTORY WARRANTY RELATING TO ITS PRODUCTS INCLUDING, BUT NOT LIMITED TO, THE IMPLIED WARRANTY OF MERCHANTABILITY, FITNESS FOR A PARTICULAR PURPOSE, OR NON-INFRINGEMENT. IN NO EVENT SHALL QUEST SOFTWARE BE LIABLE FOR ANY DIRECT, INDIRECT, CONSEQUENTIAL, PUNITIVE, SPECIAL OR INCIDENTAL DAMAGES (INCLUDING, WITHOUT LIMITATION, DAMAGES FOR LOSS OF PROFITS, BUSINESS INTERRUPTION OR LOSS OF INFORMATION) ARISING OUT OF THE USE OR INABILITY TO USE THIS DOCUMENT, EVEN IF QUEST SOFTWARE HAS BEEN ADVISED OF THE POSSIBILITY OF SUCH DAMAGES. Quest Software makes no representations or warranties with respect to the accuracy or completeness of the contents of this document and reserves the right to make changes to specifications and product descriptions at any time without notice. Quest Software does not make any commitment to update the information contained in this document.

If you have any questions regarding your potential use of this material, contact:

Quest Software Inc.
Attn: LEGAL Dept.
20 Enterprise, Suite 100
Aliso Viejo, CA 92656

Refer to our Web site (<https://www.quest.com>) for regional and international office information.

Patents

Quest Software is proud of our advanced technology. Patents and pending patents may apply to this product. For the most current information about applicable patents for this product, please visit our website at <https://www.quest.com/legal>.

Trademarks

Quest and the Quest logo are trademarks and registered trademarks of Quest Software Inc. and its affiliates. For a complete list of Quest marks, visit <https://www.quest.com/legal/trademark-information.aspx>. All other trademarks and registered trademarks are property of their respective owners.

Quest® Content Matrix
Updated February 2025
Version 9.11

Contents

Introduction	9
Supported Source Systems	9
Supported Target Systems	10
Key Features	10
Product Announcements Splash Screen	11
Automatic Updates	11
Entering the License Key	13
Online Activation	14
Offline Activation	15
Checking the Current Content Matrix Console License	16
Selecting the SQL Database You Want to Connect to	17
Content Matrix Console End User Interface	19
Main (Ribbon) Toolbar	19
Quick Access Toolbar	20
Explorer Control View Tabs	21
Explorer View Tab	21
Items View Tab	23
Browser View Tab	25
Jobs List	26
Connecting to Public Folders	27
Connecting to an Exchange Server	27
Connecting to a PST File	29
Connecting to SharePoint	32
Connecting to a SharePoint On Premises Site or Server	33
Overriding the Version of the Metalogix Extensions Web Service (MEWS) When Making a SharePoint Connection	39

Connecting to SharePoint Online	40
Using Microsoft 365 OAuth Authentication to Connect to SharePoint Online	46
Registering the Content Matrix SharePoint Client Application for OAuth Authentication	46
Completing a Connection to SharePoint Online Using Microsoft 365 OAuth Authentication	47
Migrating to Microsoft Using SPO Containers	49
Connecting with Certificates	49
Removing Certificates	51
Connecting to SharePoint Using PowerShell	51
Preparing for Your Migration	55
Creating a Target Hierarchy	55
Performing a Pre-Migration Analysis	59
Creating a SharePoint Object	63
Creating a SharePoint Site	63
Create SharePoint Site Collection	64
Create a SharePoint List	65
Create SharePoint Folder	66
Deleting SharePoint Objects	67
Initiating a Migration	69
Migrating Exchange Folders	69
Migrating Individual Exchange Items	70
Migrating Emails Directly into a SharePoint Online Document Library	70
Configuring Copying Options	72
Hierarchy Options	72
Site Options	73
Users and Permissions Options	74
Mapping Users and Permissions	75
Importing Mappings from an xml File	76
Automatic Permissions Mapping	77

Filter Options	78
General Options	80
Mapping Columns	82
Mapping Items to Content Types	83
Applying Content Types to Lists and Libraries	84
Transformations Options	85
Using PowerShell to Create Custom Transformations	86
Saving or Running a Migration Action	88
Connecting to a Full SQL Job Database	88
Saving a Job Configuration as a Template	90
Applying a Job Template	91
Managing Job Templates	92
Exporting a Job Template	92
Importing a Job Template	93
Importing and Exporting Migration Jobs Using Xml files	94
Importing Jobs from Xml Using PowerShell	95
Refreshing the Jobs List	96
Creating and Running a PowerShell Script from the Jobs List	96
Running a PowerShell Script	99
Scheduling a PowerShell Script to Run as a Windows Scheduled Task	100
Triggering a Job in the Content Matrix Console to Run Using PowerShell	101
Job Log Files	103
Log Item Details	104
Exporting Jobs to an Excel File	106
Information in Exported Excel Files	106
Copying Job Logging to Other Applications	110
Creating a Support Zip File for a Migration Job	111
Enabling Trace Logging	112

Using PowerShell with Content Matrix	114
Adding the PowerShell Snap-Ins for the Application Framework	114
Content Matrix PowerShell Commandlet List	115
Metalogix.System.Commands	115
Set-ApplicationDataPath	115
Set-CommonDataPath	115
Get-MetalogixConfigurationVariable	115
New-Filter	116
Join-Filter	116
Invoke-Filter	116
Load-MetalogixConfigurationVariableSettings	116
New-MetalogixSerializableObject	116
New-MetalogixSerializableObjectCollection	117
Set-MetalogixConfigurationVariable	117
Set-MetalogixDefaultResolverSetting	117
Metalogix.SharePoint.Commands	117
Add-MLSharePointSiteCollection	117
Add-Permissions	118
Add-SharePointFolder	119
Add-SharePointList	119
Add-SharePointSite	120
Clear-GlobalMappings	121
Compare-MLSharePointFolder	121
Compare-MLSharePointList	122
Compare-MLSharePointSite	122
Get-MLSharePointDatabase	122
Get-MLSharePointFolder	122
Get-MLSharePointFolderFromDatabase	122
Get-MLSharePointItembyFileName	123

Get-MLSharePointItembyID	123
Get-MLSharePointItemFromDatabase	123
Get-MLSharePointList	124
Get-MLSharePointListFromDatabase	124
Get-MLSharePointServer	124
Get-MLSharePointSite	124
Get-MLSharePointTenant	124
Get-SharePointSiteFromDatabase	125
Refresh-SharePointNode	125
Remove-MLSharePointFolder	125
Remove-MLSharePointItem	126
Remove-MLSharePointList	126
Remove-MLSharePointSite	127
Remove-MLSharePointSiteCollection	127
Search-SharePointSite	128
Update-SharePointSiteCollectionSettings	128
Metalogix.Jobs.Reporting.Commands	129
Export-JobHistory	129
Metalogix.Exchange.Commands	130
Copy-ExchangeItem	130
Copy-AllExchangeFolderItem	131
Copy-ExchangeFolder	131
Copy-ExchangeFolderToList	131
Modifying Content Matrix Configuration and Settings	132
Using Encrypted SQL Database Connections	132
Configuring Proxy Settings	133
Restricting Available Actions and Suppressing Events	135
ServerAdapterConfig.xml File Format	135
Actions That Can Be Disabled	136

Configuration Variable Files	139
Client Side Configuration	140
Changing Resource Utilization Settings	140
Frequently Asked Questions	142
Keyboard Shortcuts	142
Activating the License Key Silently	143
License Key Troubleshooting	143
Using Proxies, Load Balancing or Alternate Access Mappings	144
Errors Connecting to SharePoint 2019 or SharePoint Server Subscription Edition in a FIPS-Enabled Environment	145
Changing a Job Configuration for Multiple Files	145
SharePoint Site Collection Creation Issue	147
Retrying Failed Document Copies to O365 CSOM Connections	148
When Migrating to SharePoint Online HTTP Status Code 429 (“Too many requests”) or 503 (“Server Too Busy”) Message Returned	150
Error Making a Browser-Based Connection with PowerShell Console Open	150
Error: 'The object is associated with property AssociatedMemberGroup.'	151
Support for GCC High Tenants	152
About Us	153
Contacting Quest	153
Technical Support Resources	153

Introduction

Whether you are migrating Exchange Public Folders or PST files to SharePoint, Content Matrix Console - Public Folder Edition is an easy to use, convenient way of getting your data into SharePoint. With its familiar copy-and-paste style user interface, you can quickly migrate your Public Folder and PST file content into SharePoint, while preserving your valuable metadata.

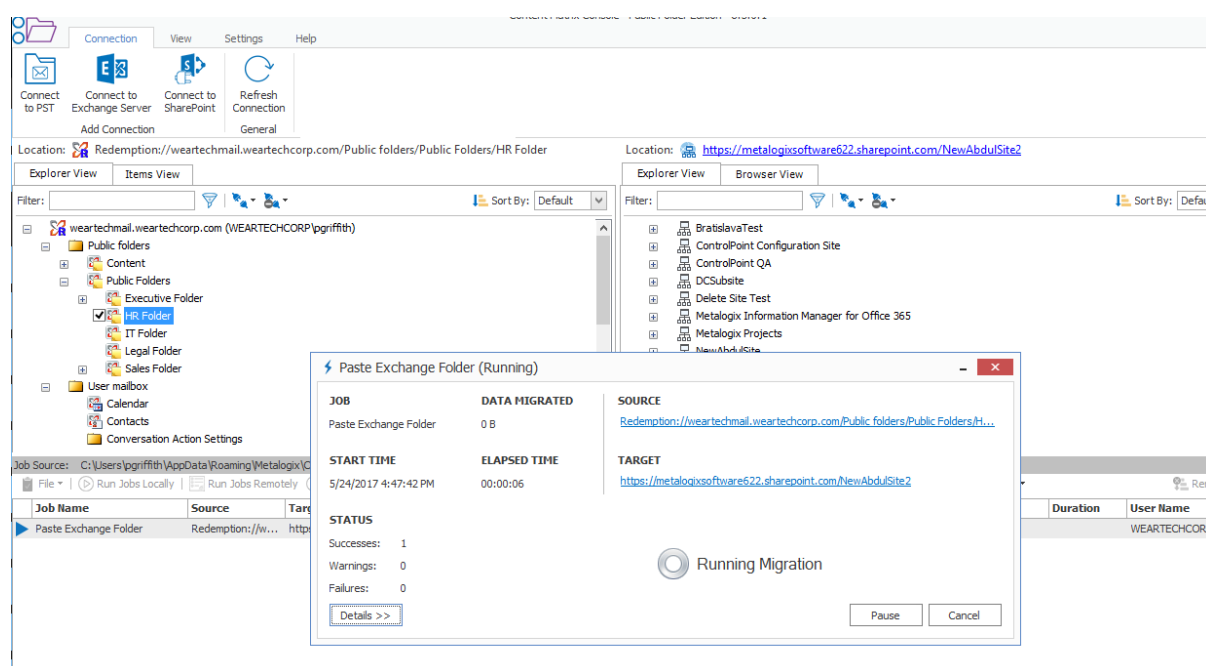

Supported Source Systems

The following source systems are supported in Content Matrix Console:

- Exchange Public Folders (from Exchange 2019, 2016, 2013, 2010, 2007, 2003, 2000)
- Exchange PST Files

Supported Target Systems

The following target systems are supported in Content Matrix Console:

- SharePoint 2016
- SharePoint 2019
- SharePoint Server Subscription Edition
- Microsoft 365 (including One Drive, Teams, and Groups)

Key Features

There are many advantages to using Content Matrix Console, including the following:

Ease of use

Similar to the Windows File Explorer, Content Matrix Console has a familiar, tree-based copy-and-paste style user interface.

Valuable data retention

All version chains, metadata, user-edit information, and most views can be preserved.

Multiple site connections

Connect to multiple SharePoint sites, across any number of servers and tenants, for easy consolidation or distribution of your SharePoint data.

Working remotely

Do all the heavy lifting for your SharePoint migration from the convenience of your own machine. Content Matrix Console connects to any SharePoint site that you can access with your browser, even those outside your organization's intranet.

Batch work

Multiple list migration operations can be batched up for convenience, and re-run at any time. Run your migrations at night and view the results/logs in the morning.

Compliance

All migration activity is done through the supported SharePoint APIs. There are no unsupported, direct writes to the SharePoint database.

PowerShell functionality

PowerShell functionality is incorporated into the Content Matrix User Interface (UI), and any action in the UI can also be performed with PowerShell. Cmdlets are also included, so scripts can be manually created and run.

Product Announcements Splash Screen

When you launch the Content Matrix Console, a splash screen displays the latest Content Matrix product announcements. If you have internet access, you will receive announcements directly from the Quest website. If you do not have internet access, the splash screen displays offline text included with your Content Matrix installation.

You have the option of preventing this screen from displaying in the future by clicking the **Do not show this screen again** box. (If you select this option, display of the splash screen will resume the next time you perform a Content Matrix Console installation or upgrade.)

Automatic Updates

Content Matrix Console can automatically check online to see if a more recent version of the product is available for download. This takes place when Content Matrix starts. To help ensure that you are taking advantage of the latest features and fixes, it provides a direct line to download and installation of new Content Matrix builds.

Automatic Upgrades requires access to the internet. While Content Matrix will check every time it is opened, it is also possible to run a manual check. To do so, go to the main toolbar and choose **Help > Check for Updates**.

If you are already running the latest build, the **Check for Updates** dialog will open, and you will be informed that you already have the latest version installed. If there is a new build available for download, the **Download and Install Update** dialog will open.

Running the Automatic Update

When Content Matrix checks for updates and finds a newer build available for download, users will be prompted to update with the **Download and Install Update** dialog.

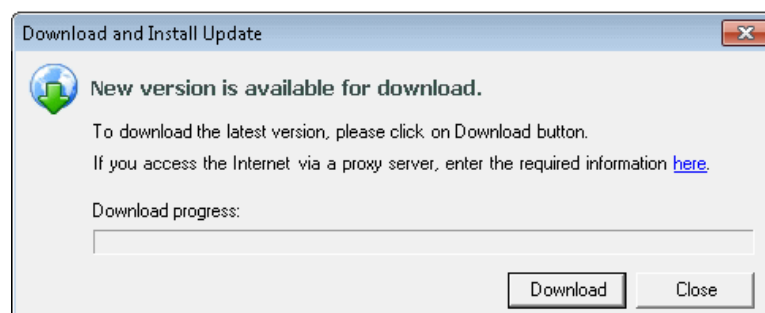

1. Click **[Download]** to directly download the latest build to your current machine.
The progress of the download is displayed in the **Download progress** bar.

NOTE: If you are accessing the internet through a proxy server, the here link can be clicked on to open the [proxy configuration](#) dialog.

2. Once the download is complete, click **[OK]** to continue.

The Download and Install Update dialog will still be open, but the Download button will be replaced with the **[Install]** button.

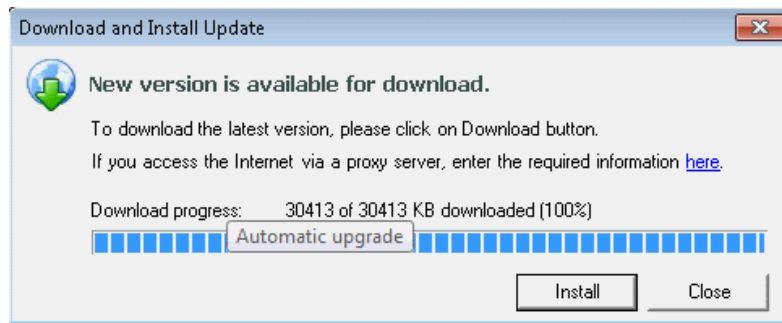

You will have the option of installing the new build directly from here by clicking the **[Install]** button. This will open the Installation guide. If you are continuing the installation process directly from this dialog, then the Content Matrix Console will close itself down, so the install process can be run.

NOTE: When running the automatic upgrade process, only the latest build of the Content Matrix Console will be updated. Any installations of the Metalogix Extensions Web Service will have to be updated manually. See the *Content Matrix Advanced Install Guide* for details.

Entering the License Key

You will be prompted to input an Activation License Key when launching the Content Matrix Console:

- for the first time after it has been installed if an existing license is not detected

OR

- after your license has expired.

NOTE: If users are not required to be a local administrators on the machine where Content Matrix is installed, every user who launches a Console needs to enter a license key. If users are required to be a local administrator, only the first user who launches a Console needs to enter a license key.

IMPORTANT: During installation, all Editions of the Console (SharePoint, File Share, and Public Folder) are installed. However, the license will only be activated for Editions that are covered by it. If an Edition is not covered by the license, the message *Invalid license: License key is not valid for the given product.* will display in the Activate License Key dialog. A license key that starts with 823, 824 or 827 will not work with File Share Edition since its reintroduction in version 9.9.

If you are performing an online activation, you can also do it [silently](#), using Powershell.

To enter a license key:

1. In the **Activate License Key** dialog, select **I have a license key**, and enter the license key provided by Quest (the key can be copied and pasted into the provided space).

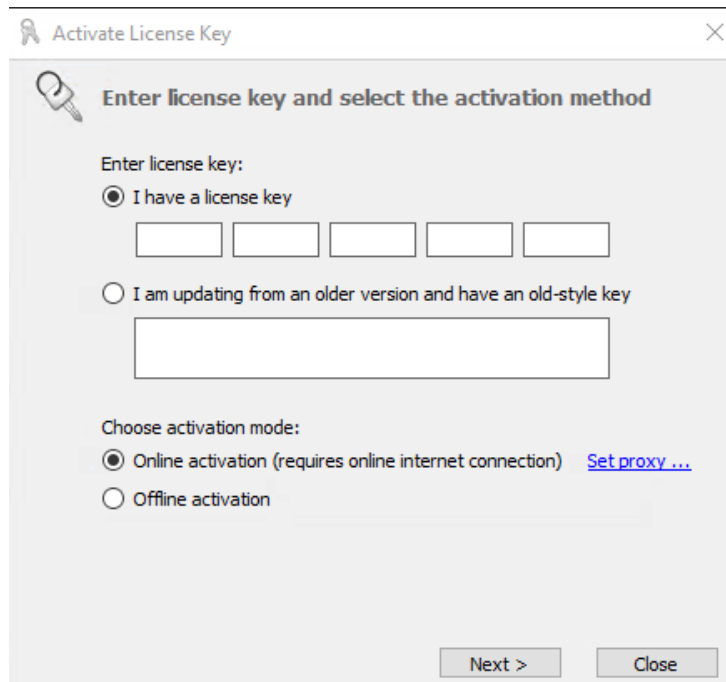

NOTE: If you are updating from a Content Matrix installation **older than version 6**, select the **I am updating from an older version and have an old-style key** option, and enter the key in the provided space (or paste into the first field from your clipboard).

2. Select the appropriate activation method.

NOTE: Most systems can use the Online activation method **as long as** the system has internet access. If you are unable to use the online activation method due to security settings or lack of internet access, the Offline activation option can be used.

Online Activation

NOTE: In order to activate your license, the following URL must be unblocked by your firewall:
<https://license.metalogix.com>

1. After entering the license key, select **Online activation**.
2. If you need to configure proxy settings:
 - Click the Set proxy... link.
 - Follow the procedure for [Configuring Proxy Settings](#).
3. Click **[Next]**.

Content Matrix will contact the licensing server and attempt to authenticate the license key, after which, on successful activation, a 'Congratulations!' message will be returned, and the license key will be active and in use.

4. Click **[Finish]** to complete the process.

Offline Activation

NOTE: The offline activation option is generally used in cases where you cannot use the online activation due to security settings or lack of internet access. This option will still require some internet access but allows for the authentication to be done from another machine that is not as restricted by security or has a connection to the internet.

1. Select **Offline activation**.
2. Click **[Next]**.
A **Generate Activation Request** dialog displays with a different key. This key can be copied from the window, or the **Save to file** option can be used to save the key into a text file (in case it needs to be copied to another machine).
3. Copy the **Activation URL** (listed under the Activation Request) to a web browser that has internet access.
Alternately if the system the Content Matrix Console is on does have internet access through a Web browser, click **Go** to automatically open a web browser to this URL.
4. On a machine that has internet access, use the Activation URL to navigate to the Offline Activation page.
5. Either:
 - Enter the key into the **Activation data** text box.OR
 - If the key was saved to a file, select **Browse** and navigate to the file.
6. Click **[Activate]**.
Upon successful activation, a new key displays in the text box.
7. Do one of the following:
 - To save the key as a DAT file, click **[Download file]**.OR
 - To copy the key to the clipboard (if the license will be activated on the same machine), click **[Copy text]**.
8. Click **[OK]** to continue.
9. Return to the Activate License dialog.
10. If the Generate Activation Request window is still active, click **[Next]**. to the **Enter your Activation Response** window.
11. Use one of the following options:
 - If you copied the key to the clipboard on the same machine, paste it into the window.
 - If you saved the key to a DAT file, navigate to, and select the DAT file.
12. Click **[Next]**. The license key will be active and in use.

13. Click **[Finish]** to complete the process.

Checking the Current Content Matrix Console License

To check the status of the license key in use, open the About dialog. Here, information such as the license type, expiration date (if any), size limitations for migrations, and how much data has already been migrated can be seen.

NOTE: If an offline license is used, the [offline activation process](#) will need to be used to do this update instead, unless the system that the Content Matrix Console is installed on has internet access.

To check the current license:

1. In the Content Matrix Console ribbon toolbar, choose **Help > About**.
2. In the dialog that opens, click **[Refresh]**. This will initiate a refresh of this data from the licensing servers and update the information.

Selecting the SQL Database You Want to Connect to

The first time you launch the Content Matrix Console you will be prompted to select the SQL database that you want to connect to. Options are:

- Connect to Job Database (SQL Server).
- Connect to New Job List (SQL Server Compact 4.0* required)
- Connect to Existing Job List (SQL Server Compact 4.0* required)

* NOTE: The use of SQL CE in a production environment is discouraged because of the following limitations:

- It uses a single .lst file that is less robust and reliable and may be corrupted after the database reaches 4 GB.
- Data compression is not supported.
- Support for large objects is limited.
- Microsoft support for SQL CE has ended.

If you still want to use SQL CE for evaluation purposes, SQL Server Compact 4.0 must already be installed on your machine. You can download it from [Microsoft](#), install it, then restart the Console.

NOTE: If you have upgraded from version 9.3 or earlier and are using SQL CE (.lst) files but SQL Server Compact is not installed, a pop-up will display. You will be given the option of either installing SQL Server Compact 4.0 or selecting a different Job database.

To create or connect to a full SQL database:

IMPORTANT: If you are connecting to an Azure SQL database, the database must already have been created via Azure Portal. You cannot create or delete an Azure SQL database from within Content Matrix.

1. From the **Please connect to a job database** dialog, select **Connect to Job Database (SQL Server)**.
2. Complete the **Connect to SQL Server** dialog:
 - If you are connecting to an **on premises SQL database**, create (using the New Database option) or select the database you want to use.

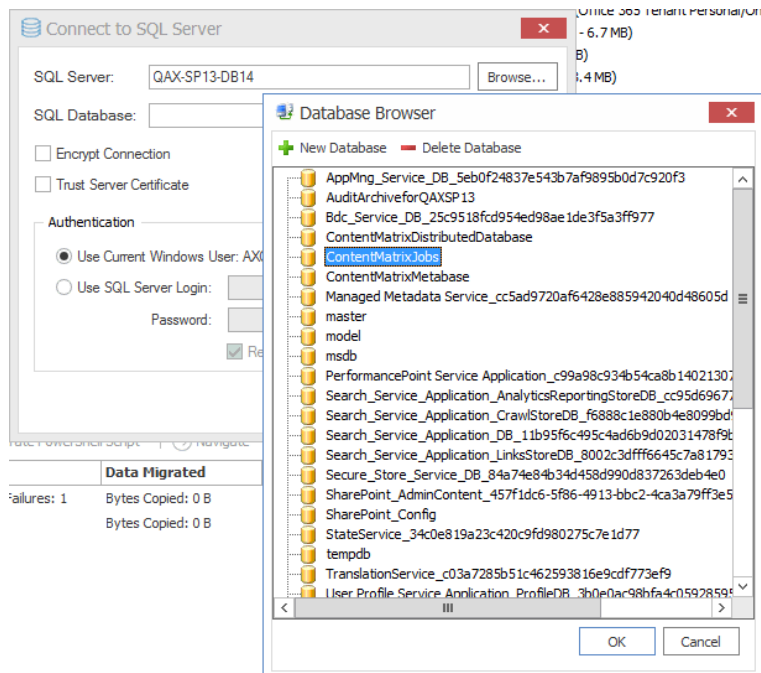

- If you are connecting to an **Azure SQL database**, select the database that has been created in Azure Portal for use by Content Matrix. (Note that the New Database and Delete Database options will be disabled.)

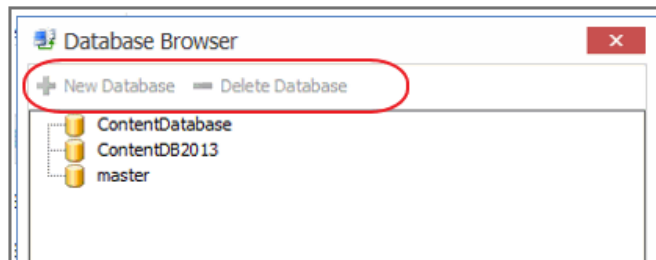

3. If you want to use an [encrypted connection](#) to the database, check the **Encrypt Connection** box.

NOTE: If the certificate used for encryption is not [trusted](#), you will also need to check the **Trust Server Certificate** box.

4. Select an **Authentication** method for connecting to SQL server:

- **Use Current Windows User**

OR

- **Use SQL Server Login**

NOTE: Currently, **Use SQL Server login** is the only valid option for an Azure SQL server.

5. Click **[OK]**.

Content Matrix Console End User Interface

The Content Matrix Console User Interface (UI) is simple and easy to use. There are three high level components to the configurable interface:

- **Explorer View 1** - At minimum, the interface will always display one Explorer Control, providing multiple ways to view the content for any active connections to source and target environments.
- **Explorer View 2** - A second explorer control can be displayed simultaneously. Having two explorers visible allows the user to simultaneously view two different parts of the connected content set. For example, in many cases it makes sense to show a migration source on the left in Explorer Control 1, and a SharePoint migration target on the right in Explorer Control 2.
- **Job List** - Beneath the Explorer Control windows is a Job list that shows the history of migration jobs and other tasks that have been run or batched in Content Matrix.

More information on these UI components is provided in the topics that follow.

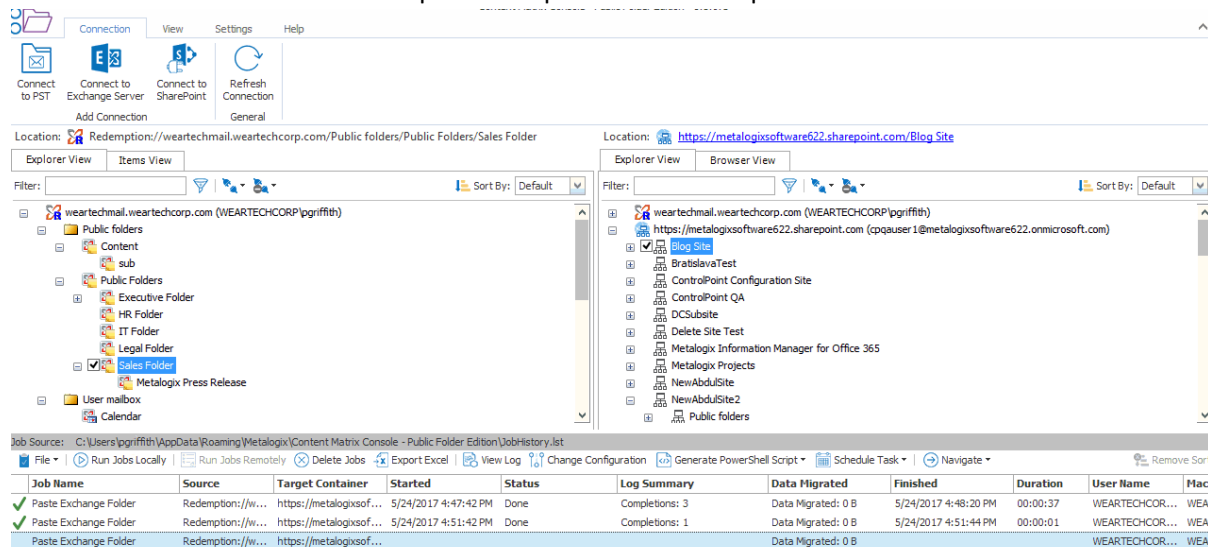

The screenshot displays the Content Matrix Console interface. At the top, there is a ribbon menu with tabs for Connection, View, Settings, and Help. Below the ribbon, there are two Explorer View windows. The left Explorer View shows a tree view of folders for 'weartechmail.weartechcorp.com (WEARTECHCORP\pgriffith)', including Public folders, sub folders, Executive Folder, HR Folder, IT Folder, Legal Folder, Sales Folder, Metalogix Press Release, User mailbox, and Calendar. The right Explorer View shows a tree view of folders for 'https://metalogixsoftware622.sharepoint.com/Blog_Site', including Blog Site, BratslavaTest, ControlPoint Configuration Site, ControlPoint QA, DCSubsite, Delete Site Test, Metalogix Information Manager for Office 365, Metalogix Projects, NewAbdulSite, NewAbdulSite2, and Public folders. Below the Explorer Views, there is a Job List table showing migration jobs.

Job Name	Source	Target Container	Started	Status	Log Summary	Data Migrated	Finished	Duration	User Name	Mach
Paste Exchange Folder	Redemption://w...	https://metalogixsof...	5/24/2017 4:47:42 PM	Done	Completions: 3	Data Migrated: 0 B	5/24/2017 4:48:20 PM	00:00:37	WEARTECHCOR...	WEAR
Paste Exchange Folder	Redemption://w...	https://metalogixsof...	5/24/2017 4:51:42 PM	Done	Completions: 1	Data Migrated: 0 B	5/24/2017 4:51:44 PM	00:00:01	WEARTECHCOR...	WEAR
Paste Exchange Folder	Redemption://w...	https://metalogixsof...				Data Migrated: 0 B			WEARTECHCOR...	WEAR

Main (Ribbon) Toolbar

At the top of the Content Matrix Console is a ribbon toolbar allowing access to the following five menu group settings:

- **Connection**
- **View**
- **Settings**

- **Help**

The Content Matrix Console menu ribbon can be expanded or minimized to fit the user's needs. When expanded, a set of options will be available depending on the selected menu heading.

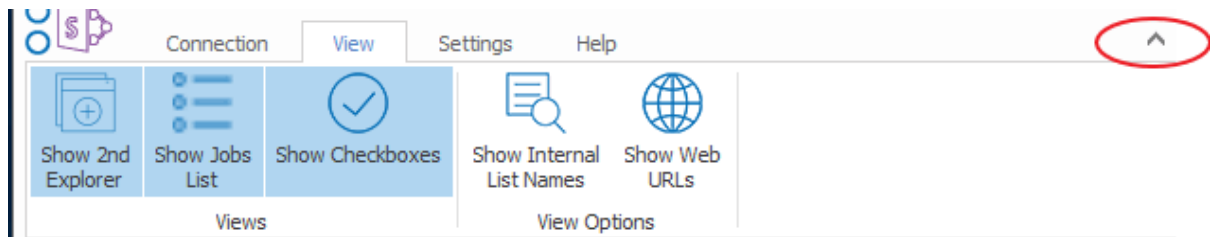

When minimized, options will only be visible when a menu heading is selected. Otherwise, only menu headings will show. The minimize and expand options can also be accessed by right clicking an option in the ribbon itself. This opens a context (right-click) menu where the **Minimize the Ribbon** option can be selected or deselected.

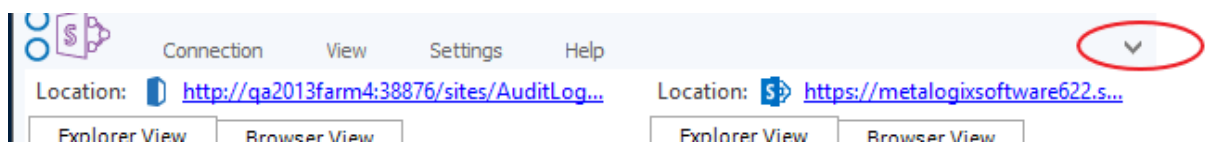

Quick Access Toolbar

The **Quick Access Toolbar** can be accessed above the ribbon. The Quick Access Toolbar can also be moved just below the ribbon by selecting the drop down menu (on the top left-hand side) and choosing **Show Quick Access Toolbar Below the Ribbon**, or it can be placed back above the ribbon by choosing **Show Quick Access Toolbar Above the Ribbon**. Any option that is available under one of the menu group headings can have a shortcut for the option placed into the Quick Access Toolbar. This can be done by right-clicking on the option in the ribbon, and choosing **Add to Quick Access Toolbar**.

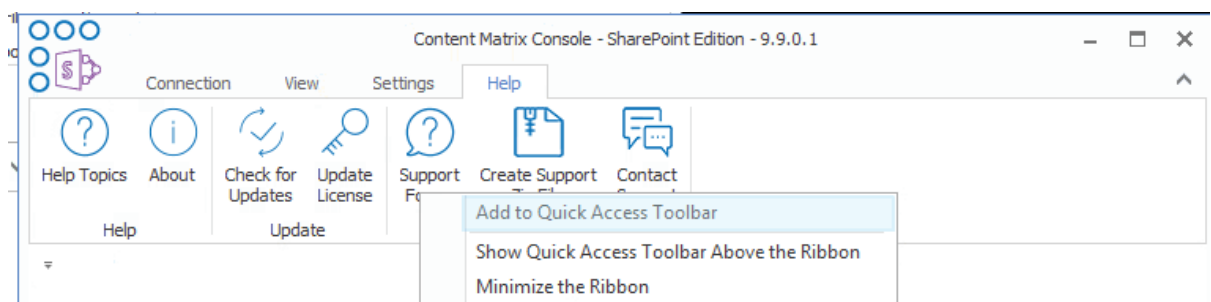

Shortcuts can also be removed from the Quick Access Toolbar either by selecting the option within the ribbon and opening the context (right-click) menu or by selecting the shortcut option itself, opening the context (right-click) menu, and choosing **Remove from Quick Access Toolbar**.

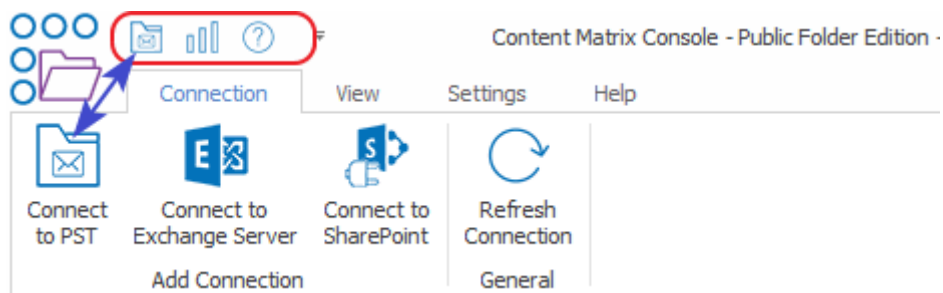

Explorer Control View Tabs

The Content Matrix Console user interface uses an Explorer Control style window which allows you to navigate, view, and select the desired content for migration. The Explorer Control window is broken up into three separate tab options, each of which contains its own set of options for viewing content and data. They are:

- [Explorer View Tab](#)
- [Items View Tab](#)
- [Browser View Tab](#)

Explorer View Tab

The Explorer view tab allows you to navigate through your various connections in a tree view. You can navigate to and select a desired SharePoint site collect, site, list/document library or sub-folder or a under a specific connection or navigate to a specific Exchange Server or PST file.

There are a set of filtering options that are available in this tab, as well as a set of ordering options. This allows you to display, sort, and filter all your connections as desired.

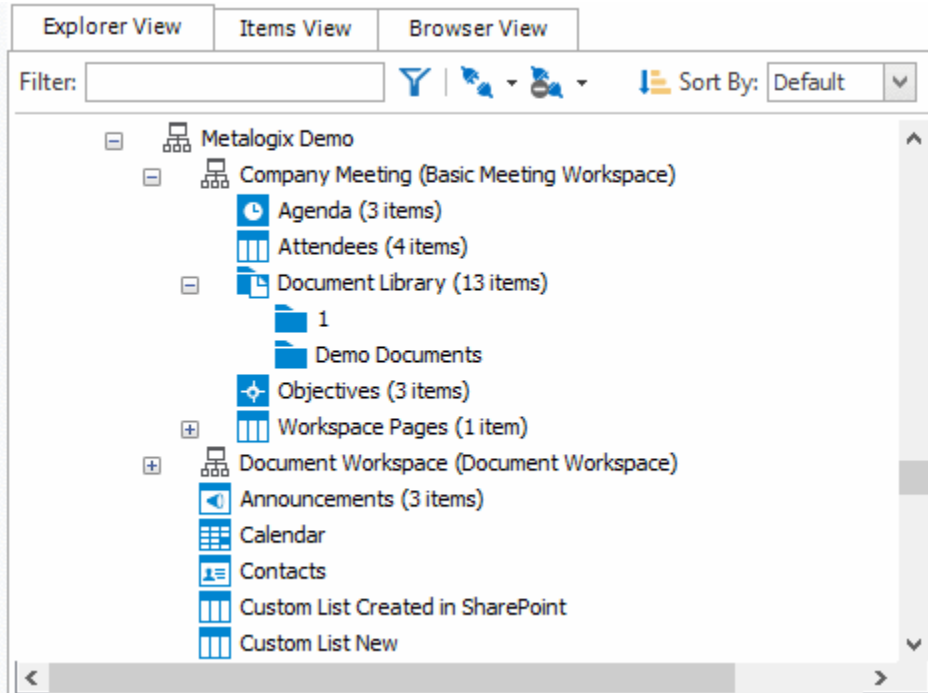

There are three primary Filtering options: **Text Filter**, **Connections Filter**, and **Status Filter**.

- **Text Filter:** For example, if you only want to view connections that contain "2010" in the URL, you can enter "2010" in the Filter text box and click the Filter button to the right of the text value. The filter will then be applied to all connections in that Explorer View tab, and only connections that contain a "2010" value will be displayed.



NOTE: To remove a text box filter, delete the filter value from the text box and re-run the filter action.

- **Connections Filter** - This option consists of a drop-down menu that allows you to filter by connection type. By default, all of these options are selected, but one or more can be DE-selected.

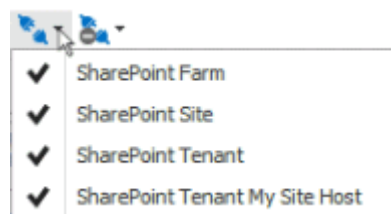

- **Status Filter** - This option consists of a drop-down list with the various connection status options:
 - **NotChecked** – Content Matrix has not tried to validate the connection yet.
 - **Checking** - Content Matrix is currently trying to validate the connection.

- **Valid** - Content Matrix has tried to validate the connection and has been successful. A connection has been established.
- **Invalid** - Content Matrix has tried to validate the connection and has been unsuccessful. A connection has not been established.
- **Warning** - Content Matrix has tried to validate the connection and has been successful. A connection has been established, however, a warning message has been given.

By default all of the status types are selected but, as with the Connections Filter, one or more can be de-selected.

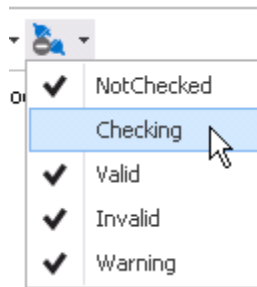

You can also Sort by

- **Default** - All of the connections in the order they were added.
- **Type** -These are the same types that are listed in the Connections Filter drop down menu. When selected, connection types will be sorted in the following order:
 - Exchange PST files
 - Exchange Servers
 - SharePoint farms (this includes all Web App and Farm connection to a server, as well as Database connections)
 - SharePoint Site connections, which include Site connection types, and Read-only connections to SharePoint

You can combine various filter and sort options.

Items View Tab

The Items View tab displays any items/documents that exist directly under the selected node (that is, the content of any subfolders under the selected node-will not be displayed), along with column metadata.

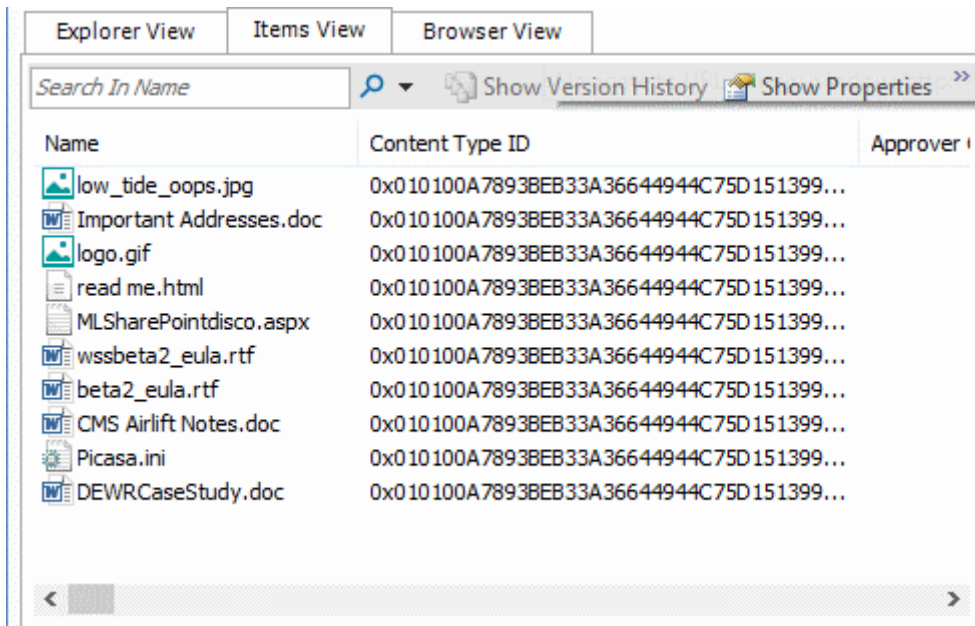

There are four main options that are available through this tab. These options are:

- **Search** – To perform a full or partial text search, enter the string in the search box then either and either press <Enter>, or click the magnifying glass icon to run the search.

NOTE: The search will be run on the name column (the FileLeafRef) by default, but you can select a different column to search from the drop-down to the right of the search box.

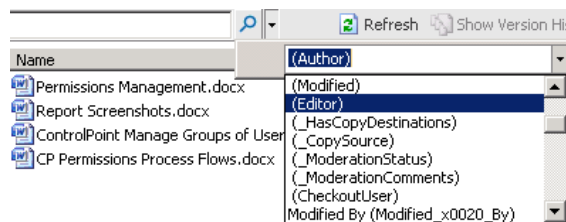

- **Refresh** - This button will refresh all of the items in the Items View tab.
- **Show/Hide Version History** - This button option is only available when the selected document library/list has versioning configured. When this button is selected the Items View tab will be divided into two sections, a top section displaying all of the items/documents and a bottom section displaying all of the versions for the selected item/document.

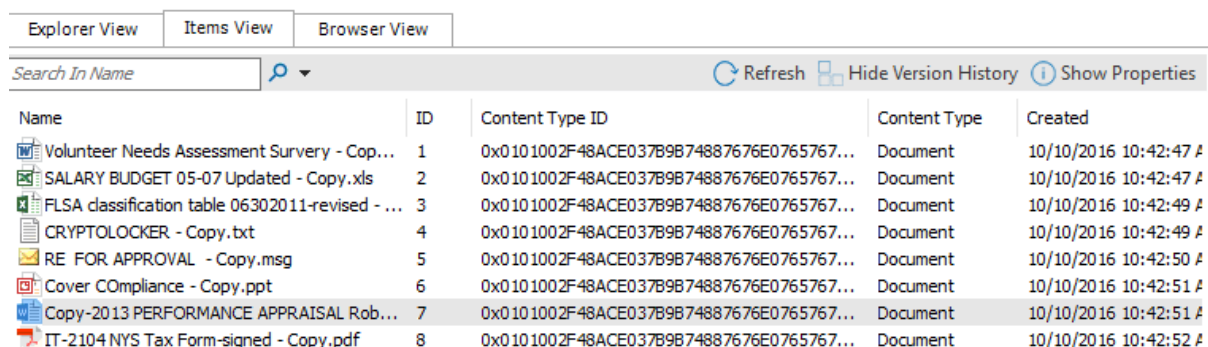

When an item/document is selected in the top window, all of that item/document's version's will be listed in the bottom half of the window. You can then look at the metadata for each item/document version that exists. This option can be combined with the **Show/Hide Properties** button.

If the **Show Version History** button has already been selected, this will change to be a **Hide Version History** button instead. You can use this option to stop looking at item/document version histories.

- **Show/Hide Properties** - The **Show Properties** button allows you to see a list-style view of the available fields (columns) and their values, for a selected item/document. Any value listed in dark text can be edited and within the window.

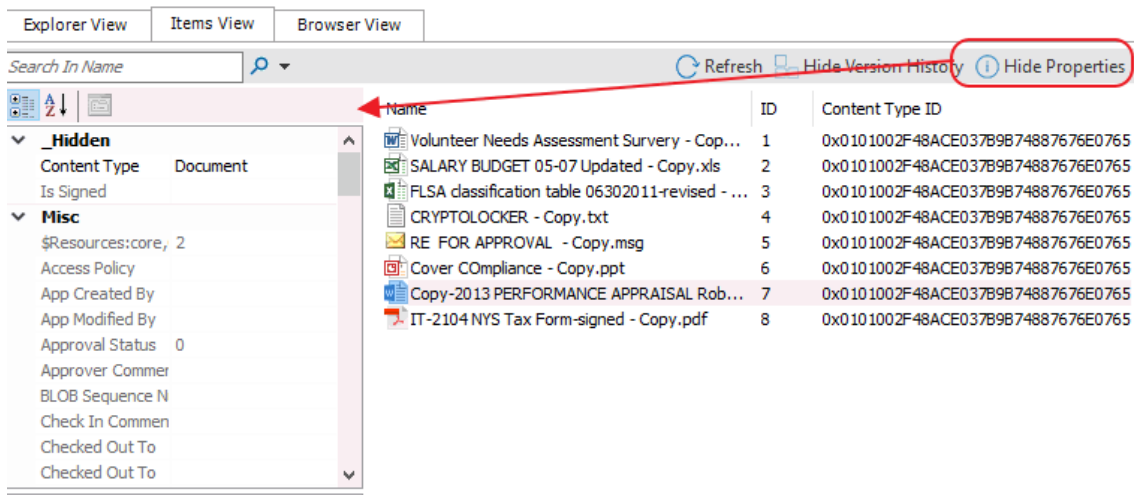

The fields in the **Properties** window can also be ordered by category, or alphabetically. By default, the fields are ordered by category, and are listed alphabetically within each category. If listed alphabetically, then all property fields (columns) will be listed in alphabetical order, with no breakdown by category. There are two buttons at the top of the Properties window that can be used to determine what ordering type is used. This option can be combined with the **Show/Hide Version History** button.

If the **Show Properties** button has already been selected, this will change to be a **Hide Properties** button instead. Use this option to close the Properties window.

Browser View Tab

The **Browser View** displays a view of the content as it would be seen in a web browser for a selected node. It is also available if selecting a single item in the **Items View**. When selected, this tab will display a fully functioning web browser view of the selected content. You can use this Browser View to navigate or work with their content, the same way they would through a normal web browser window.

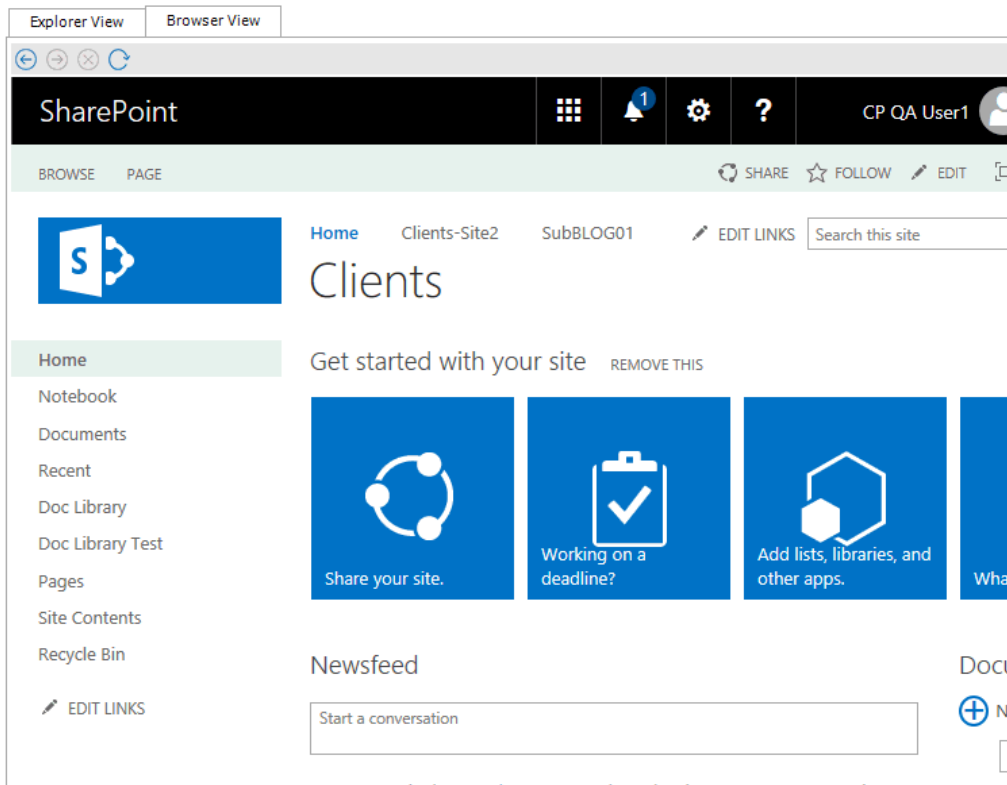

Jobs List

Jobs in Content Matrix Console can be managed from the Job List. Jobs are listed for migration actions that have already been run, as well as for actions that have been saved.

Job Source: C:\Users\doconnor\AppData\Roaming\Metalogix\Content Matrix Console - SharePoint Edition\JobHistory.lst

Job Name	Source	Target Container	Started	Status	Log Summary	Data Migrated	Finished	Total Duration	User Name	Machine Name
Paste Site Collection	http://qa2013fa...	https://metalogixof...				Bytes Copied: 0 B			METALOGIX\doc...	BOSTON-SP...
✓ Paste List Views	http://qa2013fa...	https://metalogixof...	5/18/2020...	Done	Completions: 2, Skipped: 1	Bytes Copied: 0 B	5/18/2020 1:45:24 PM	00:00:13	METALOGIX\doc...	BOSTON-SP...
✓ Paste Site as Subsite	http://qa2013fa...	https://metalogixof...	5/18/2020...	Done	Sites Copied: 1, Lists Copied:...	Bytes Copied: 273.7 kB	5/18/2020 1:45:10 PM	00:06:46	METALOGIX\doc...	BOSTON-SP...

Connecting to Public Folders

There are two basic types of connections that can be made to Public Folders: [Connections to Exchange Servers](#) and [Connections to PST](#).

Connecting to an Exchange Server

To connect to an Exchange Server:

1. In Content Matrix Console ribbon toolbar, choose **Connection > Connect to Exchange Server** to display the **Exchange Server Logon** dialog.

2. For **Mailbox profile**, select a value from the drop-down.





NOTE: If you selected Outlook, all settings will be automatically filled in.



3. If you selected **Custom profile settings**:

- a) Enter a User mailbox (e.g. jsmith@company.com). Then specify whether it is the mailbox of the Currently logged on user or Different user.
- b) In the Server settings section, enter the name of the Exchange server and select a Connector type:
 - **Exchange Web Services (EWS)** - This is the Exchange web services connector type. When this connector is selected, any public folder can be opened in Content Matrix. Please note that for this connector type only eml message format is supported as the output file format for migration into SharePoint. EWS must be allowed on the Exchange server.

NOTES:

- This option is not available if you selected **Outlook** as the Mailbox profile.
- Content Matrix does not support EWS connections to Exchange Online, and connections to Exchange Online are not possible because Microsoft has deprecated EWS basic authentication.
- **Messaging Application Programming Interface (MAPI)** - This connector type can be used only if Outlook (32bit) is installed on the local computer. When MAPI is selected, only the logged on user can browse and view public folders for which they have been given rights. However, this connector type supports msg as well as eml output formats for migration. With the msg file format, the full, original Outlook fidelity is retained and the attachment and message header and body are all contained within a single msg file in SharePoint. If Outlook is installed as the default mail client, and users double-click on the migrated msg file in the web browser in SharePoint, the message will open in Outlook and all Outlook actions are available to the user directly, e.g., Reply, Forward, etc.
- **Messaging Application Programming Interface (Redemption)** - This is the preferred connection method. This connector type requires CDO (Collaboration Data Objects) or Outlook (32bit or 64bit) installed on the local computer. Other features are the same as with MAPI connector type.

Environment	MAPI	Redemption
32bit OS and 32bit Outlook		
32bit OS and CDO (Collaboration Data Objects)	-	
64bit OS and 64bit Outlook	-	

Environment	MAPI	Redemption
64bit OS and 32bit Outlook		(Content Matrix Console - Public Folder Edition32.exe) 
64bit OS and CDO (Collaboration Data Objects)	-	(Content Matrix Console - Public Folder Edition32.exe) 

NOTES:

- To apply the **Redemption** connector type in 64bit OS and 32bit Outlook (or CDO) environment, Content Matrix Console - Public Folder Edition has to be started via the Content Matrix Console - Public Folder Edition32.exe file instead of the conventional Content Matrix Console - Public Folder Edition.exe file.
- Content Matrix Console - Public Folder Edition32.exe is located under: C:\Program Files (x86)\Metalogix\Content Matrix Console\Public Folder Edition\.

4. If you selected the **EWS** Connector type, either:

- select the Server version from the drop-down and enter the **EWS URL** and **OWA URL** then click **[OK]**.

OR

- click **[Discover]** button to open the Auto Discover dialog. Enter the **User mailbox** and user credentials if necessary then click **[Start]**.

Exchange Server settings in the Exchange Server logon dialog will be filled in automatically.

Connecting to a PST File

To connect to a PST file:

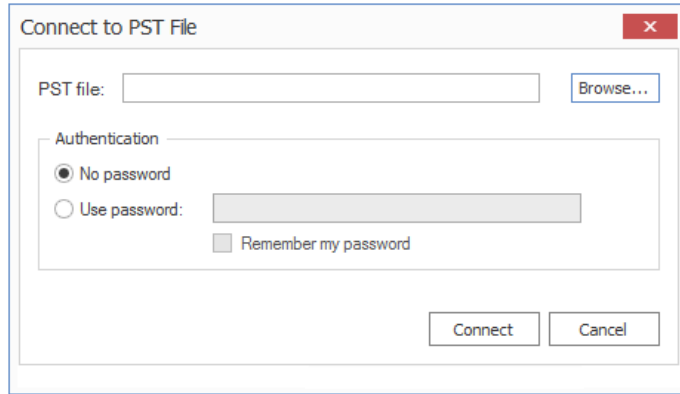

1. In the Content Matrix Console ribbon, choose **Connection > Connect to PST** to display the **Connect to PST File** dialog.



2. For **PST file**, either:

- enter the location of the PST file
- OR
- click [**Browse**] and navigate to the desired PST file.

NOTE: The Connect to PST feature requires Outlook (32bit or 64bit).

Environment	Connect to PST
32bit OS and 32bit Outlook	
32bit OS and CDO (Collaboration Data Objects)	-
64bit OS and 64bit Outlook	
64bit OS and 32bit Outlook	(Content Matrix Console - Public Folder Edition32.exe) 
64bit OS and CDO (Collaboration Data Objects)	-

NOTES:

- To apply the Redemption connector type in 64bit OS and 32bit Outlook (or CDO) environment, Content Matrix Console - Public Folder Edition has to be started via the Content Matrix Console - Public Folder Edition32.exe file instead of the conventional Content Matrix Console - Public Folder Edition.exe file.
- Content Matrix Console - Public Folder Edition32.exe is located under: C:\Program Files (x86)\Metalogix\Content Matrix Console\Public Folder Edition\. Content Matrix Console - Public Folder Edition32.exe does not support the SharePoint Local Object Model (OM) connection.







3. If the PST file is password protected, click the **Use password** radio button, then enter the password for the PST file. If you check the **Remember my password** box, the next time that Content Matrix is started it will connect to the PST file without the need to type in the password again.

Connecting to SharePoint

The following basic connection adapters are supported for making connections to SharePoint from Content Matrix Console:

- A local connection to a SharePoint site or server
- A remote connection to a SharePoint site or server
- A client side object model (CSOM) connection for SharePoint Online at the site level

The following table identifies the connection adapter types for each supported version of SharePoint:

SharePoint Server Type	Local Object Model (OM) Connection (Content Matrix Console - installed on server) *	Remote Object Model (OM) Connection (Metalogix Extensions Web Service installed on remote server)	SharePoint Client Side Object Model (CSOM) Connection
Microsoft 365	-	-	
Microsoft SharePoint 2016			-
Microsoft SharePoint 2019	 **	 **	-
Microsoft SharePoint Server Subscription Edition	 **		--

* Content Matrix Console - Public Folder Edition32.exe does not support the SharePoint Local Object Model (OM) connection.

** Currently, if Content Matrix is installed in a FIPS-enabled environment, you cannot connect/migrate to SharePoint 2019. For SharePoint Server Subscription Edition in a FIPS-enabled environment, you can only connect using a remote object model connection. See [Errors Connecting to SharePoint 2019 or SharePoint Server Subscription Edition in a FIPS-Enabled Environment](#) for more information.

Connecting to a SharePoint On Premises Site or Server

The same connection methods and options can be used for a normal connection to SharePoint and a read-only connection to SharePoint. The below steps can be used for both connection types. The read-only connection can be used to help users keep their source and target connection separate (and it can help ensure that users do not accidentally migrate any data to a source connection).

NOTES:

- When making a secure connection to a SharePoint URL that is configured with TLS, Content Matrix can use any version of TLS that is compatible with .NET Framework 4.8. The default version of TLS used by the operating system on the machine from which you are connecting will be used by Content Matrix.
- Currently, connections to a SharePoint server cannot be made for SharePoint 2019 in a FIPS-enabled environment. (See [Errors Connecting to SharePoint 2019 or SharePoint Server Subscription Edition in a FIPS-Enabled Environment](#) for more information.)

To connect to a SharePoint site or server:

In the Content Matrix ribbon, choose **Connection > Connect to SharePoint**.

SharePoint Logon

Connection Options

Proxy Options

Included Certificates

Address:

Target Type: Site Web App Farm

Connection Type: Auto Detect

Authentication Type: Auto Detect

Connect As

AXCELERTEST\testbenchfarm

Different user:

Password:

Remember my password

Override SharePoint Online Tenant Domain Name

OK Cancel

To complete the Connection Options tab:

1. For **Address**, enter either the URL or IP address of the SharePoint site or server to which you want to connect.

Note that the drop-down menu displays a list of previous connections.

2. For **Target Type**, select the connection type. Use the information in the following table for guidance.

If you want to connect...	Select ...
directly to a SharePoint site	Site.
to a specific Web application on a SharePoint server	Web App. NOTE: This option can only be used if using the Local or Metalogix Extensions Web Service connection type.
to a SharePoint instance at the Farm/server level (which will allow you to see all site collections for all Web Application on the selected server)	Farm. NOTE: This option can only be used if using the Local or Metalogix Extensions Web Service connection type.

3. Select a **Connection Type** from the drop-down. Use the information in the following table for guidance.

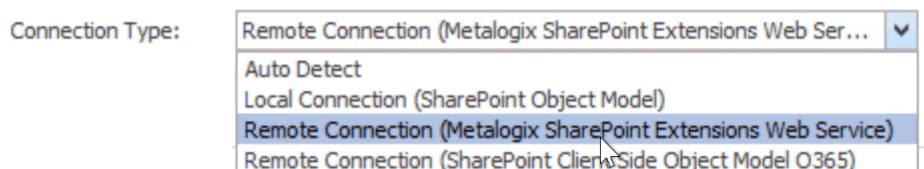

If ...	Select ...	Notes
you want to have Content Matrix choose the connection adapter type that makes the most sense for the target SharePoint instance	Auto Detect	<ul style="list-style-type: none"> • If the SharePoint instance is local (installed on the same machine as the Content Matrix Console), the Local Connection (SharePoint Object Model) will be used • If the SharePoint instance is remote (installed on another machine), and the Metalogix Extensions Web Service is installed, the Remote Connection

If ...	Select ...	Notes
		<p>(Metalogix Extensions Web Service) type will be used.</p>
<p>Content Matrix Console is installed locally (that is, on the same SharePoint server or one of its Web Front Ends (WFEs))</p>	<p>Local Connection (SharePoint Object Model)</p>	<p>This connection type</p> <ul style="list-style-type: none"> is generally recommended for the target SharePoint instance if possible, to help with performance and to help provide the product with greater leverage into SharePoint. <p>AND</p> <ul style="list-style-type: none"> the account used for the connection. must be the logged in user and have the following permissions: <ul style="list-style-type: none"> Farm Administrator Site Collection Administrator DB_Owner on the Content Database (to allow the connecting user access to the local SharePoint Object Model). <p>A local connection to a SharePoint server cannot be made for SharePoint Server Subscription Edition in a FIPS-enabled environment. (See Errors Connecting to SharePoint 2019 or SharePoint Server Subscription Edit in a FIPs-Enabled Environment for more information.)</p>
<ul style="list-style-type: none"> Content Matrix Console is not installed locally <p>AND</p> <ul style="list-style-type: none"> Metalogix Extensions Web Service (MEWS) is installed on the SharePoint server/WFE to which you are connecting 	<p>Remote Connection (Metalogix Extensions Web Service)</p>	<p>The connecting account requires Full Control over the content being connected to and migrated. Additional permissions are provided through the use of the Metalogix Extensions Web Service.</p> <p>NOTE: Although it is strongly recommended that the version of the Metalogix Extensions Web Service (MEWS) match the installed version of Content Matrix, you can override it to use an earlier MEWS version.</p>

NOTE: As of version 9.5, Content Matrix no longer supports CSOM connections to SharePoint on premises. The option will work for backward compatibility with existing jobs, but if you select it for a new connection, a pop-up warning will display.

4. For **Authentication Type**, select the method to use when trying to connect to the specified SharePoint instance.

Use the information in the following table for guidance.

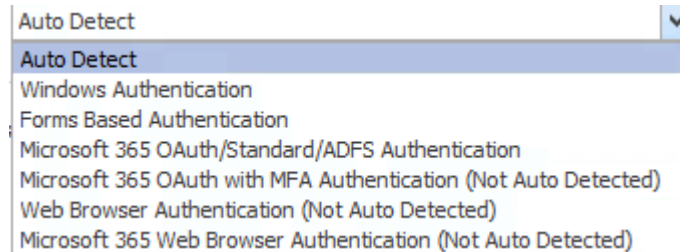

If ...	Select	Notes
you want Content Matrix to automatically check against the SharePoint environment	Auto Detect	Content Matrix will check for non-Microsoft 365 authentication types listed in the drop-down (in order), and use the first method that is found.
you want to connect to the SharePoint environment using the currently logged in Windows user's credentials	Windows Authentication	<ul style="list-style-type: none"> The logged in user credentials are used by default; however, other credentials that use this authentication method can also be entered. This is the authentication type that most environments use.
<ul style="list-style-type: none"> you selected Metalogix Extensions Web Service as the Connection Type <p>AND</p> <ul style="list-style-type: none"> you want to connect using Forms Based Authentication 	Forms Based Authentication	<ul style="list-style-type: none"> Most setups for Forms Based Authentication are supported. This method is limited to the Metalogix Extensions Web Service connection type because it authenticates through IIS and not Active Directory (AD). <p>NOTE: This authentication type is not supported for running a job using a PowerShell script. Refer to the Quest Support Knowledge Base article Connections that will work with PowerShell and Connections that</p>

If ...	Select ...	Notes
		<p>doesn't work with PowerShell for complete details.</p>
<p>you want to connect through a Web browser</p>	<p>Web Browser Authentication (Not Auto Detected)</p>	<p>This option is not searched for within the “Auto Detect” option, and needs to be manually set.</p> <p>In order for the Content Matrix Console to logon to the system, users must have logged on to the system being connected to through the web browser on that system first (only before the initial connection). Since this is all done using the Web browser for authentication, the credentials section of the window will be grayed out (since it is not needed), and it is limited to the Metalogix Extensions Web Services Connection Type because it authenticates through IIS and not the Active Directory (AD).</p> <p>NOTES:</p> <ul style="list-style-type: none"> • Because this authentication type uses cookies from the browser, it may require multiple logins when running a single migration. However, this is only likely if the migration is running for a long session; this is mainly determined by the web browser settings for authentication. In the event that a login is required, a dialog box appears that lets users log in. After the user logs in, the migration will continue from where it left off. • This authentication type is not supported for running a job using a PowerShell script. Refer to the Quest Support Knowledge Base article Connections that will work with PowerShell and Connections that doesn't work with PowerShell

If ...	Select ...	Notes
		for complete details.

5. For **Connect As**, enter/select the login credentials you want to use to connect to the SharePoint site/server. Use the information in the following table for guidance.

NOTE: This option is disabled if you selected **Local Connection (SharePoint Object Model)** or **Web Browser Authentication (Not Auto Detected)**.

If you want to ...	Then ...
use the current Windows user's authentication credential	Select the (default) <Domain>\<user> radio button.
use different authentication credentials	<ul style="list-style-type: none"> Select the Different User radio button, and Enter the applicable user name and Password. <p>In cases where alternate credentials are entered, it is recommended that you select the Remember my password check box so Content Matrix will automatically remember that user account password. This is especially important if you chose Web Browser Authentication, as credentials must be stored in the Credential Manager vault before the connection is made.</p>

6. If you need to configure proxy settings:
- Select the **Proxy Options** tab.
 - Follow the procedure for [Configuring Proxy Settings](#).

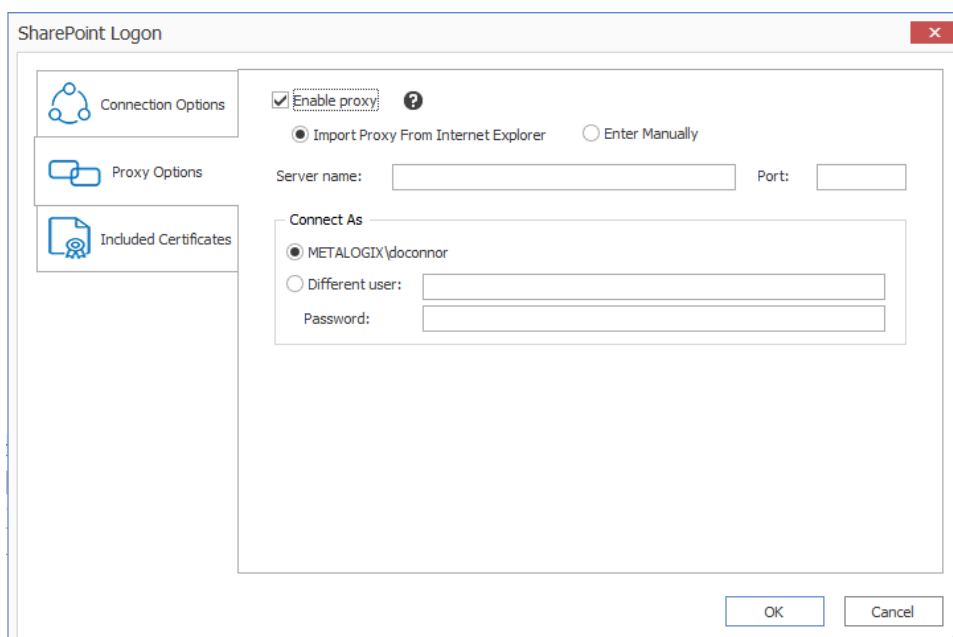

7. If you want to Add or Remove certificates to be included when connecting to SharePoint:

a) Select the **Included Certificates** tab.

Please see the [Connecting with Certificates](#) for more details on connecting to SharePoint instances that require certificates.

b) After all of the desired connection options have been set, for all options tabs, click **[OK]** to establish the connection.

If you selected a connection type other than Site, the Limit Site Collections dialog displays, giving you the option to limit the site collections to include in your connection (when importing an xml file with the list of URLs you want to include). This is useful if the environment you are connecting to includes a very large number of site collections. In this case, limiting displayed site collections can improve performance.

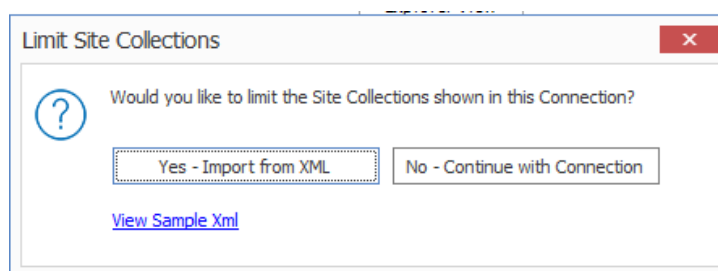

NOTE: If you want to **View Sample xml**, click the link on the dialog. The xml file you import must follow the same format as this sample.

8. Either:

- Click **[Yes – Import from XML]** to specify the URLs of the sites you want to include in the connection, then browse/upload the file

OR

- Click **[No – Continue with Connection]** to add all sites within the selected scope to the connection.

If Content Matrix successfully makes the connection, a new node will appear in the Explorer View, and you can expand this node and navigate through the SharePoint objects.

Overriding the Version of the Metalogix Extensions Web Service (MEWS) When Making a SharePoint Connection

It is strongly recommended that when you select **Remote Connection (Metalogix SharePoint Extensions Web Service)** to connect to SharePoint, the version of MEWS is installed on the remote server is the same as the installed version of Content Matrix Console. However, when you select MEWS as the connection type, you will have the option to **Override the MEWS Version** and specify an earlier MEWS Version (in the format n.n.n.n) when making a connection. Note that you will receive a warning message that the installed version of MEWS may be incompatible.

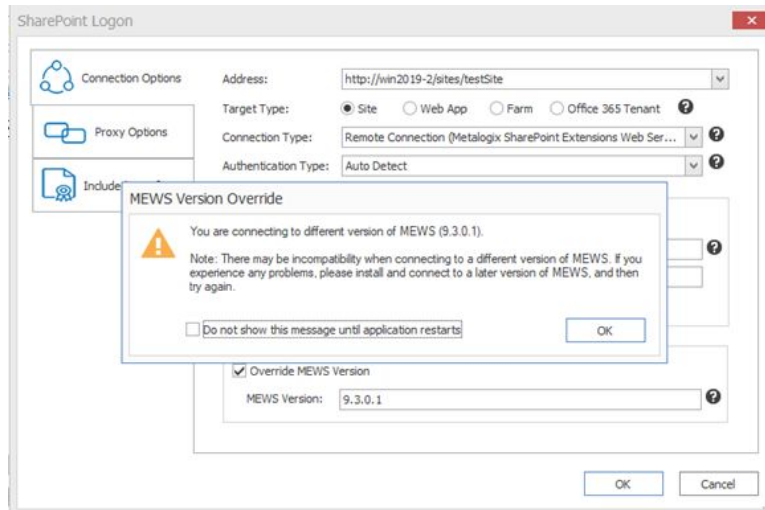

You can hide the warning message for any new connections and re-connections made during the current session by checking the **Do not show this message until application restarts** box.

IMPORTANT: You cannot update the MEWS version once the connection has been created.

If the MEWS version is overridden, the job log will display the warning message. (If both the source and target connections use an older version of MEWS, an entry will display for each.)

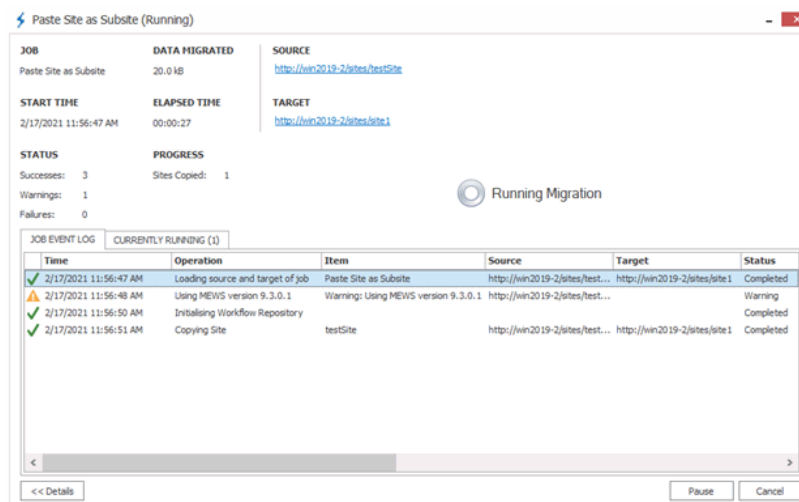

Connecting to SharePoint Online

Content Matrix Console can make a site level connection to a SharePoint Online environment.

To connect to SharePoint Online:

In the Content Matrix ribbon, choose **Connection > Connect to SharePoint**.

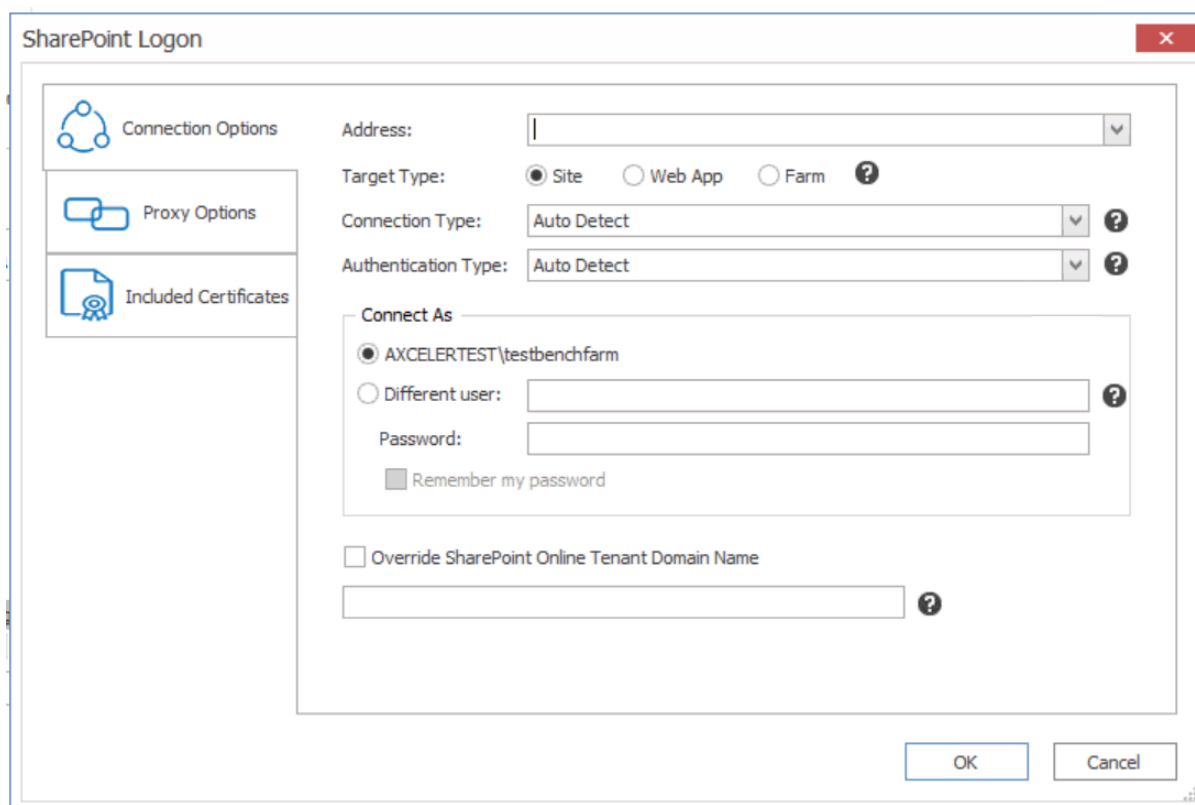

Make sure the selected **Target Type** is **Site**.

To complete the Connection Options tab:

1. For **Address**, enter either the URL or IP address of the SharePoint site or tenant to which you want to connect.

Note that the drop-down menu displays a list of previous connections.

2. For **Target Type**, select the connection type. Use the information in the following table for guidance.
2. For **Target Type**, select **Site**.
3. For **Connection Type**, select **Remote Connection (SharePoint Client Side Object Model O365)**.

NOTE: If you accept the default (**Auto Detect**), this option will be detected automatically.

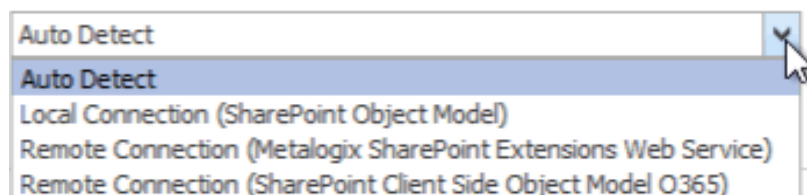

4. For **Authentication Type**, select the method to use when trying to connect to the specified SharePoint instance. When connecting to Microsoft 365, the two main Authentication Types will be

Microsoft 365 OAuth/Standard/ADFS Authentication and Microsoft 365 Web Browser Authentication (Not Auto Detected). Use the information in the following table for guidance.

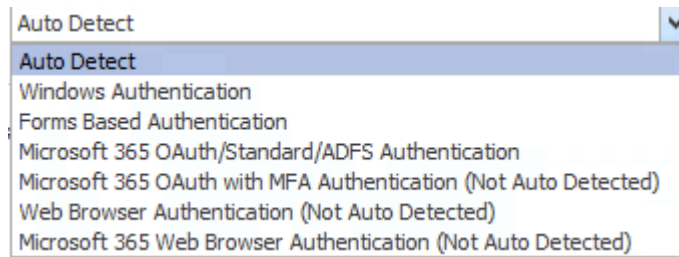

For a SharePoint Online connection that uses "modern" (not "legacy") authentication, you must select one of the Microsoft 365 OAuth Authentication options or Microsoft 365 Web Browser. If the account is also part of a [SharePoint Online Multi-Factor Authentication Policy](#), Microsoft 365 Web Browser or Microsoft 365 OAuth with MFA Authentication must be used.

NOTE: Microsoft 365 Web Browser Authentication is not supported for jobs run from a PowerShell script.

For more information about legacy vs. modern authentication, refer to the Microsoft article [Microsoft 365 feature descriptions](#).

If ...	Select ...	Notes
you want Content Matrix to automatically check against the SharePoint environment	Auto Detect	Content Matrix will check for authentication types listed in the drop-down (in order), and use the first method that is found. NOTE: At the time you click [OK] to complete the connection, a pop-up box will display that asks if you want to use Microsoft 365 OAuth. See Using Microsoft 365 OAuth Authentication to Connect to SharePoint Online for details.
<ul style="list-style-type: none"> you want to connect to Microsoft 365 OAuth, Microsoft 365 – Standard editions, or systems with ADFS AND <ul style="list-style-type: none"> MFA is not being used 	Microsoft 365 OAuth/Standard/ADFS Authentication*	By default the logged in user credentials will be unavailable, since this uses the Windows authentication method, and the Microsoft 365 credentials will need to be entered. NOTE: At the time you click [OK] to complete the connection, a pop-up box will display that asks if you want to use Microsoft 365 OAuth. See Using Microsoft 365 OAuth Authentication to Connect to SharePoint Online for details.

If ...	Select ...	Notes
your account requires the use of Multi-Factor Authentication (MFA)	Microsoft 365 OAuth with MFA Authentication (Not Auto Detected)*	With this authentication type, you do not have to enter account credentials in Content Matrix, and the Connect As options will be disabled.
you want to connect through a Web browser	Web Browser Authentication (Not Auto Detected)	<p>This option is not searched for within the “Auto Detect” option, and needs to be manually set.</p> <p>In order for the Content Matrix Console to logon to the system, users must have logged on to the system being connected to through the web browser on that system first (only before the initial connection). Since this is all done using the Web browser for authentication, the credentials section of the window will be grayed out (since it is not needed).</p> <p>NOTES:</p> <ul style="list-style-type: none"> • Because this connection method uses cookies from the browser, it may require multiple logins when running a single migration. However, this is only likely if the migration is running for a long session; this is mainly determined by the web browser settings for authentication. In the event that a login is required, a dialog box appears that lets users log in. After the user logs in, the migration will continue from where it left off. • This authentication type is not supported for running a job using a PowerShell script. Refer to the Quest Support Knowledge Base article Connections that will work with PowerShell and Connections that doesn't work with PowerShell for complete details.

If ...	Select ...	Notes
<p>you want to connect through a Web browser using authentication for Microsoft 365</p>	<p>Microsoft 365 Web Browser Authentication</p>	<p>This option works the same as Web Browser Authentication (Not Auto Detected) <i>except</i>:</p> <ul style="list-style-type: none"> • it looks for more specific Microsoft 365 cookies • it requires that users first log into Microsoft 365 through the browser • instead of allowing multiple logins, only one "request" for data can be made at a time, which ensures that no data is missed or lost due to the system locking from too many requests (but which may result in a slower connection). <p>NOTE: This authentication type is not supported for running a job using a PowerShell script . Refer to the Quest Support Knowledge Base article Connections that will work with PowerShell and Connections that doesn't work with PowerShell for complete details.</p>
<p>you want to make a site-level connection to a GCC High site using Microsoft 365 User Provided Authentication</p>	<p>Microsoft 365 User Provided Authentication (hidden by default)</p>	<p>You must first run a utility provided by Quest Support and enable the setting EnableUserProvidedAuthentication. Refer to the Quest Support Knowledge Base article Enabling User Provided Authentication in Content Matrix for details.</p>

* If you are connecting to SharePoint Online using OAuth authentication and you used a custom domain as the **Address**, you will also need to check the **Override SharePoint Online Tenant Domain Name** and enter the *default* tenant domain name (which can be found at <https://admin.microsoft.com/Adminportal#/Domains>) to allow Content Matrix to route the request to the proper region.

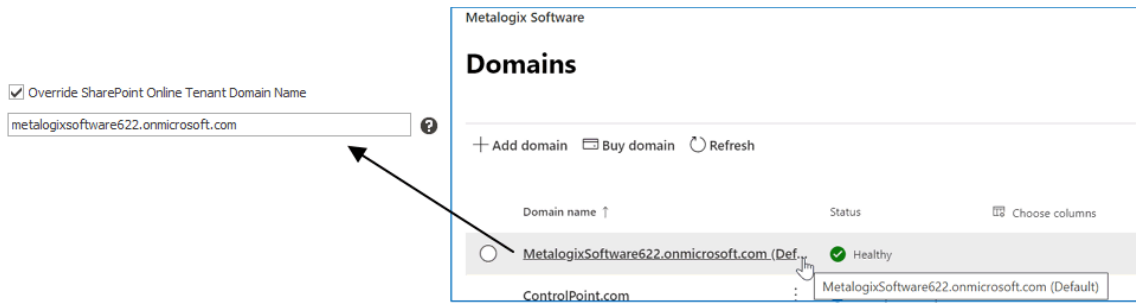

5. For **Connect As**, enter/select the login credentials you want to use to connect to the SharePoint site/server. Use the information in the following table for guidance.

NOTE: This option is disabled if you selected **Microsoft 365 OAuth with MFA Authentication**, or **Web Browser Authentication (Not Auto Detected)**.

If you want to ...	Then ...
use the current Windows user's authentication credential	Select the (default) <Domain>\<user> radio button.
use different authentication credentials	<ul style="list-style-type: none"> Select the Different User radio button, and Enter the applicable user name and Password. <p>In cases where alternate credentials are entered, it is recommended that you select the Remember my password check box so Content Matrix will automatically remember that user account password. This is especially important if you chose Web Browser Authentication, as credentials must be stored in the Credential Manager vault before the connection is made.</p>

6. If you want to Add or Remove certificates to be included when connecting to SharePoint:

- a) Select the **Included Certificates** tab.

Please see the [Connecting with Certificates](#) for more details on connecting to SharePoint instances that require certificates.

- b) After all of the desired connection options have been set, for all options tabs, click **[OK]** to establish the connection.

If Content Matrix successfully makes the connection, a new node will appear in the Explorer View (two if you opted to include One Drives), and you can expand the node(s) and navigate through the SharePoint objects.

NOTE: Should the log file ever show a "could not find site on remote SharePoint server" exception message when working with CSOM connections, simply restart the CSOM service on all machines running the Content Matrix console and then rerun the action.

Using Microsoft 365 OAuth Authentication to Connect to SharePoint Online

Microsoft 365 OAuth Authentication is a token-based authentication method that can be used as an alternative to Standard/ADFS Authentication to reduce throttling.

If Multi-Factor Authentication is set up for the tenant and enabled for the account (as described in the Microsoft TechNet article [SharePoint Online - Microsoft 365: Set up Multi-Factor Authentication](#)), you can connect using **M365 OAuth with MFA Authentication** as an alternative to Microsoft 365 Web Browser authentication.

Registering the Content Matrix SharePoint Client Application for OAuth Authentication

The very first time OAuth Authentication is selected, the application **Content Matrix SharePoint Client** must be registered for the tenant.

IMPORTANT: Prior to version 9.2, the **Metalogix SharePoint Migration Client** application was used for OAuth Authentication. Jobs created before version 9.2 (including those that use PowerShell) will continue to use this application (as long as it is still registered in Entra ID). Starting with version 9.2, all jobs using OAuth Authentication will use the **Content Matrix SharePoint Client** application.

Required Permissions

At a minimum, the following permissions are required to register and provide consent for the Content Matrix SharePoint Client application.

- For a **site-level connection**, the account must have a minimum of **Site Administrator** and **Application Administrator** permission roles.
- For a **tenant-level connection**, the account must have a minimum of **Application Administrator** permission role.

Providing Consent to Grant the Application Requested Permissions

The first time a Content Matrix user attempts to connect to SharePoint Online using Microsoft 365 OAuth Authentication, a dialog displays requesting that you grant the permissions that the application needs to perform migrations.

A Global Administrator can check the **Consent on behalf of your organization** box, which will prevent this dialog from displaying for other users. If the account is not a Global Administrator, the **Consent on behalf of your organization** option will be hidden.

IMPORTANT: If a Global Administrator does not consent on behalf of the organization, each Content Matrix user who attempts to connect using Microsoft 365 OAuth Authentication for the first time must sign in with an account that has the **Application Administrator** and **SharePoint Administrator** permission role.

After **[Accept]** is clicked, the connection is created (and the application will be registered if it does not already exist in Entra ID). In addition, the token cache file **ConnectionsTokenCache.dat** is created in the AppData/Roaming/Metalogix folder. (Note, if you have used OAuth Authentication in an earlier version of Content Matrix, this file will already exist.)

Completing a Connection to SharePoint Online Using Microsoft 365 OAuth Authentication

When you select one of the Microsoft 365 OAuth authentication types, before making a connection to SharePoint Online, a pop-up specific to the authentication type will display, as described in the following table.

NOTE: If you click the **Do not show the message again.** box, Content Matrix will continue to use the selected option and no longer display the pop-up. You can resume having the pop-up display by clicking **Reset Configuration Options** on the ribbon toolbar Settings tab.

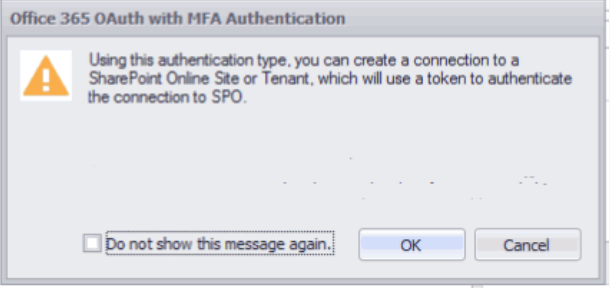
If you selected...	Then ...
<p>Auto Detect or Office365 OAuth/Standard/ADFS Authentication</p>	<p>the pop-up will prompt you to use the Microsoft 365 OAuth option.</p>  <p>Choose either [Yes - Use OAuth] or [No - Use Microsoft 365 Standard/ADFS].</p>
<p>Microsoft 365 OAuth with MFA Authentication (Not Auto Detected)</p>	<p>the pop-up will describe this authentication type.</p> 

Signing into your Microsoft 365 Account to Use Microsoft 365 OAuth Authentication

When prompted to sign into your Microsoft 365 account, for **Auto Detect** or **Microsoft 365 OAuth/Standard/ADFS Authentication**, you must use the account you specified as the **Connect As** account in Content Matrix. The connection will fail if you try to sign in with another account. (This is not an issue with **Microsoft 365 OAuth with MFA Authentication**, which does not use a Connect As account.)

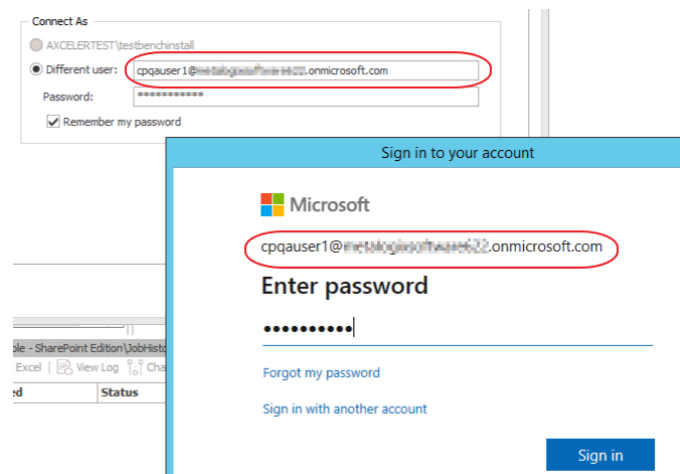

IMPORTANT: If you are using OAuth Authentication for the first time, a dialog may display requesting that you consent to granting permissions that the application needs to perform migrations. To provide this consent, the account must be an **Application Administrator**. (This dialog will not display [if a Global Administrator has granted consent on behalf of the organization.](#))

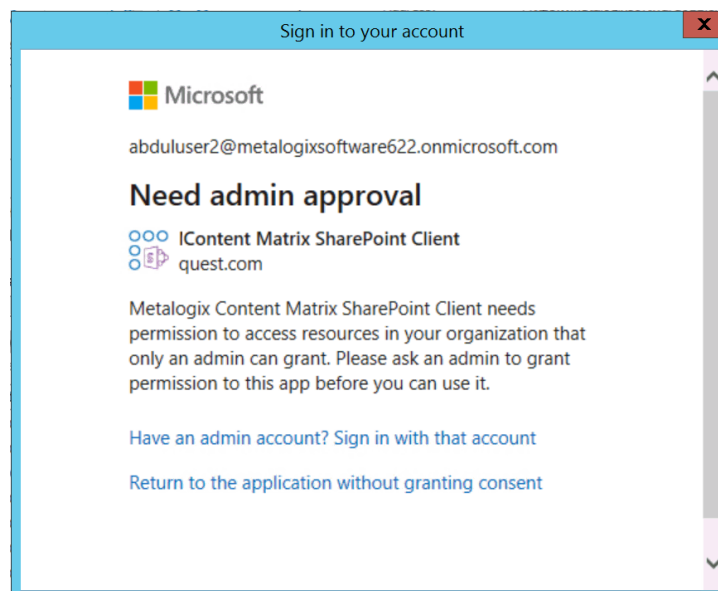

Migrating to Microsoft Using SPO Containers

Content Matrix supports the migration of Public Folders using shared SPO containers when migrating to SharePoint Online. When you select this option, migration of large files (15 GB or more) is supported for all source connection types. The **Use SPO Container Microsoft 365 Upload** option is enabled on the [Configure Copy Options dialog- Site Options](#) tab by default.

Connecting with Certificates

When connecting to SharePoint, there are two options that can be used to add certificates to the list of included certificates: **Add Installed Certificate** and **Add Certificate From File**.

SharePoint connections do not actually save the certificate information directly, but instead they save the data on how to locate the certificates that are in use. This means that if the certificates are deleted or moved from the referenced location, they will no longer be used with the SharePoint connection and will have to be manually re-added.

SharePoint Certificates are also supported when generating a [PowerShell](#) script. It is still recommended that the initial SharePoint connection is first configured in the Content Matrix Console. The recommended process when working with certificates and PowerShell is to first add the connection (with certificates) in Content Matrix, then set up a migration action in the UI and generate a PowerShell script. This will allow you to get the connection format that is required to create a connection in PowerShell, and it can then be written out manually (if desired).

It should also be noted that the **Web Browser Authentication** type does not automatically detect certificates. In order for certificates to be included with this method, they must first be installed in the appropriate locations in order for a web browser itself to access them.

NOTE: In some cases, including certificates can potentially result in receiving "maximum request length" messages when migrating smaller files because the certificate information is included when the data is being migrated.

To Add Installed Certificates:

Only "Personal" certificates can be added in this manner because it is the only store that web browsers use to find certificates when accessing a website.

1. In the **SharePoint Logon** dialog, select the **Include Certificates** tab.

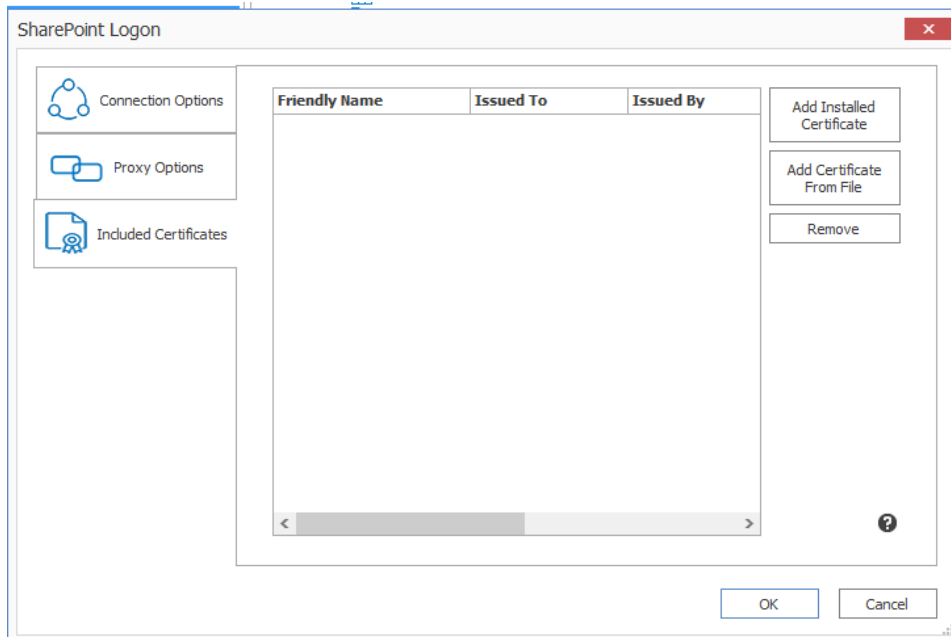

2. Click **[Add Installed Certificate]**.

The **Add Installed Certificates** dialog displays all of the certificates that are installed in the logged in user account's "Personal" certificate store.

3. Select any certificates that should be included, and click **[OK]**.

When you return to the **SharePoint Logon** dialog the selected certificates be displayed in the **Included Certificates** list, and they will be included whenever Content Matrix is running an action to or from the SharePoint connection.

To Add a Certificate from a file:

1. In the **SharePoint Logon** dialog, select the **Include Certificates** tab.

2. Click **[Add Certificate From File]**.

3. Either:

- enter a filename and location into the **Certificate File** text box

OR

- select the **Browse** button to open a file explorer dialog and navigate to, and select, the desired certificate.

4. If a password is required to use with the certificate, enter it in the **Password (optional)** text box.

NOTE: When a connection to SharePoint is made, Content Matrix will save the password field for any certificates so it can re-establish a connection to that SharePoint instance at a later date. If you are not comfortable with entering the password in the Password (optional) field, you can move the certificate into the user account's "Personal" folder, and use the [Add Installed Certificate](#) option instead, provided the user account/password is the same.

When you return to the **SharePoint Logon** dialog, the selected certificate will display in the **Included Certificates** list, and it will be included whenever Content Matrix is running an action to or from the SharePoint connection.

Important Note About Self-Signed Certificates

For security purposes, Content Matrix always attempts to validate a certificate when connecting to a TLS/SSL site. Content Matrix cannot validate a self-signed certificate for an on-premises connection however, and if it attempts to do so you will be unable to complete the connection. To avoid this issue, you must change the value of the key `BypassCertificateValidation` in the [EnvironmentSettings.xml](#) file to **True**.

Removing Certificates

Any certificates that have previously been added through the two **Add Certificates** options can also be removed from the list of **Included Certificates**.

To remove a certificate:

1. In the **SharePoint Logon** dialog, select the **Include Certificates** tab.
2. Select the certificate(s) that you want to remove.
3. Click **[Remove]**.

Connecting to SharePoint Using PowerShell

You can create and edit connections to SharePoint using PowerShell. These connections will be displayed in the Content Matrix Console.

To access the PowerShell cmdlets for connecting to SharePoint:

Open a PowerShell or PowerShell ISE session and [add the PowerShell snap-ins for the application framework](#).

The following cmdlets are now available:

- [Get-MLSharePointConnections](#)
- [New-MLSharePointConnection](#)
- [Set-MLSharePointConnection](#)
- [Remove-MLSharePointConnection](#)

To retrieve information about active connections in the Console:

Select (from the PowerShell ISE Command Window) or enter **Get-MLSharePointConnections**, then run the cmdlet.

Details display for each active connection.

To create a new connection to SharePoint:

1. Select (from the PowerShell ISE Command Window) or enter **New-MLSharePointConnection**.
2. Select or enter the applicable parameters. Use the information in the following table for guidance.

Parameter	Notes
Address (Required)	The Url of the SharePoint object (Site, Farm, WebApp or Tenant) you want to connect to.
AuthenticationType (Required)	<p>Valid values are:</p> <ul style="list-style-type: none"> • Windows • FormsBased • Adfs <p>NOTE: Currently this cmdlet does not support connecting to SharePoint Online with OAuth authentication.</p> <ul style="list-style-type: none"> • UserProvided <p>NOTE: UserProvided authentication is used to make site-level connections to special types of tenants, such as GCC High. To use this type of authentication, you must first run a utility provided by Quest Support and enable the setting EnableUserProvidedAuthentication. Refer to the Quest Support Knowledge Base article Enabling User Provided Authentication in Content Matrix for details.</p>
ConnectionType (Required)	<p>Valid values are:</p> <ul style="list-style-type: none"> • Om (local object model) • MEWS (remote connection using Metalogix Extensions Web Service) • CSOM (for SharePoint Online targets only)
TargetType (Required)	<p>Valid values are:</p> <ul style="list-style-type: none"> • Site • WebApp • Farm

Parameter	Notes
ConnectAsCurrentUser	Use this parameter if you want to make a SharePoint on-premises connection using the currently logged-in user. NOTE: This parameter is not necessary when using an OM connection, which automatically connects as the currently logged-in user.
MewsVersion	This parameter is only necessary if you want to use an older version of the Metalogix Extension Web Service .
Password	The password of the account making the connection.
RememberPassword	This option is recommended to ensure that the connection remains active after the PowerShell session has ended. If it is not used, the password will have to be re-entered.
ReadOnly	Use this parameter if you want to make a read-only connection to a SharePoint source.
SkipConnectionCheck	Use this parameter if you want to skip validation of the connection. This is useful if you use a connections factory and speeds up the creation of connections.
User	The user account making the connection.

3. Run the cmdlet.

Example Scripts:

```
New-MLSharePointConnection -Address http://win-pvf4cd21m55/ -
AuthenticationType Windows -ConnectionType MEWS -TargetType Site -Password
"Pass" -User Administrator -RememberPassword
```

```
New-MLSharePointConnection -Address https://metalogixsoftware-
admin.sharepoint.com -AuthenticationType Adfs -ConnectionType Csom -
TargetType Tenant -Password "Pass" -RememberPassword -User
cpqauser@metalogixsoftware.onmicrosoft.com
```

To edit a connection to SharePoint:

1. Select (from the PowerShell ISE Command Window) or enter **Set-MLSharePointConnection**.
2. Enter the **ConnectionId**.

NOTE: You can obtain the ConnectionId by running the **Get-MLSharePointConnections** cmdlet.

You can now update any of the following parameters, then run the cmdlet:

- **ConnectAsCurrentUser** (on premises connections only)

- **Password**
- **RememberPassword**
- **SkipConnectionCheck**

NOTE: Use this parameter if you want to skip validation of the connection. This is useful if you use a connections factory and speeds up the creation of connections.

- **User**

Example Script:

```
Set-MLSharePointConnection -ConnectionId '91335f9c-9311-439e-9b8e-78d6f7ef480a' -Password pass -RememberPassword -User Administrator
```

To remove a SharePoint connection:

1. Select (from the PowerShell ISE Command Window) or enter **Remove-MLSharePointConnection**.
2. Enter the **ConnectionId**.

NOTE: You can obtain the ConnectionId by running the **Get-MLSharePointConnections** cmdlet. You can remove multiple connections using the PowerShell pipeline variable.

3. Run the cmdlet.

Example Scripts:

```
Remove-MLSharePointConnection -ConnectionID '2F91B056-C300-4263-9FA6-17EEDF583594'
```

Remove multiple connections using the PowerShell pipeline variable:

```
Remove-MLSharePointConnection -ConnectionID '2F91B056-C300-4263-9FA6-17EEDF583594', '2F91B056-C300-4263-9FA6-17EEDF583594', '2F91B056-C300-4263-9FA6-17EEDF583594' | Remove-MLSharePointConnection
```

Preparing for Your Migration

Content Matrix offers a number of tools to help you locate and organize data and in preparation for your migration. You can:

- [Create a target SharePoint hierarchy prior to migration](#)
- [Perform a pre-migration analysis](#)
- [Create SharePoint objects](#)
- [Delete SharePoint objects](#)

Creating a Target Hierarchy

When migrating Public Folder content, there are two options for creating the target SharePoint hierarchy. In Microsoft Exchange, it is possible to create Calendars, Contact and Task lists on any level. They can be included in any of the existing folders. However, SharePoint does not support such hierarchies, and lists can only be created under a SharePoint site. Content Matrix tries to create a corresponding structure in SharePoint that is as close as possible to the original Public Folder hierarchy on Exchange, based on the available options (that have been configured to a users preferences).

NOTE: Content Matrix supports target URLs for Public Folders migrated to SharePoint Online of up to 400 characters, which is the maximum length that SharePoint Online allows.

Flattened (Folder) Hierarchy

In choosing this option, simple Public Folders will be migrated as SharePoint document libraries for the root level, using subfolders within the given document library. Customized SharePoint lists (Calendars, Contact and Task lists) will be created on the root level. The name of the target library and lists will contain the path to the MS Exchange list in the original structure, as shown below:

Migration Example 1

MS Exchange	MS SharePoint
Root\Folder 1\Subfolder 1\Test calendar	Root\Folder 1_Subfolder 1_Test calendar

Migration Example 2

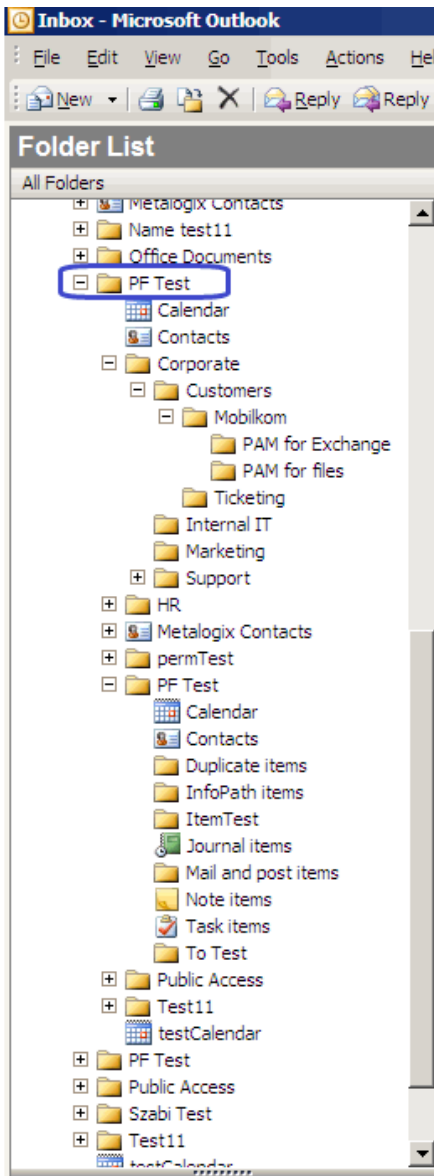

-> Migration using flattened hierarchy model ->

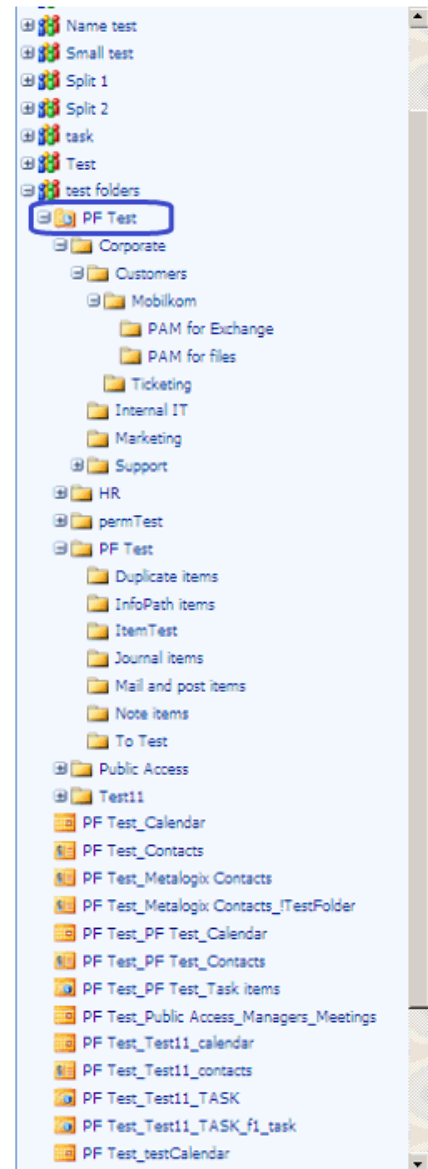

Site Hierarchy

If you would like to retain the exact parent-child hierarchy in SharePoint that was originally in your Exchange public folder hierarchy, choose **Site Hierarchy Creation**.

In this case:

- SharePoint Sites are created for every folder level in the original structure.
- On the corresponding site SharePoint Lists or libraries are created for every Exchange public folder:
 - Document libraries for every Mail and Post Items public folder.
 - Task lists for every Exchange Tasks public folder.
 - Calendars for every Exchange calendar public folder.

- Contact list for every Exchange contact public folder list.
- Document libraries for any other type of Exchange public folder.

Items in the root folder in Exchange will be placed in a Document Library (or other list) named 'Items'.

Sample Migration Diagram

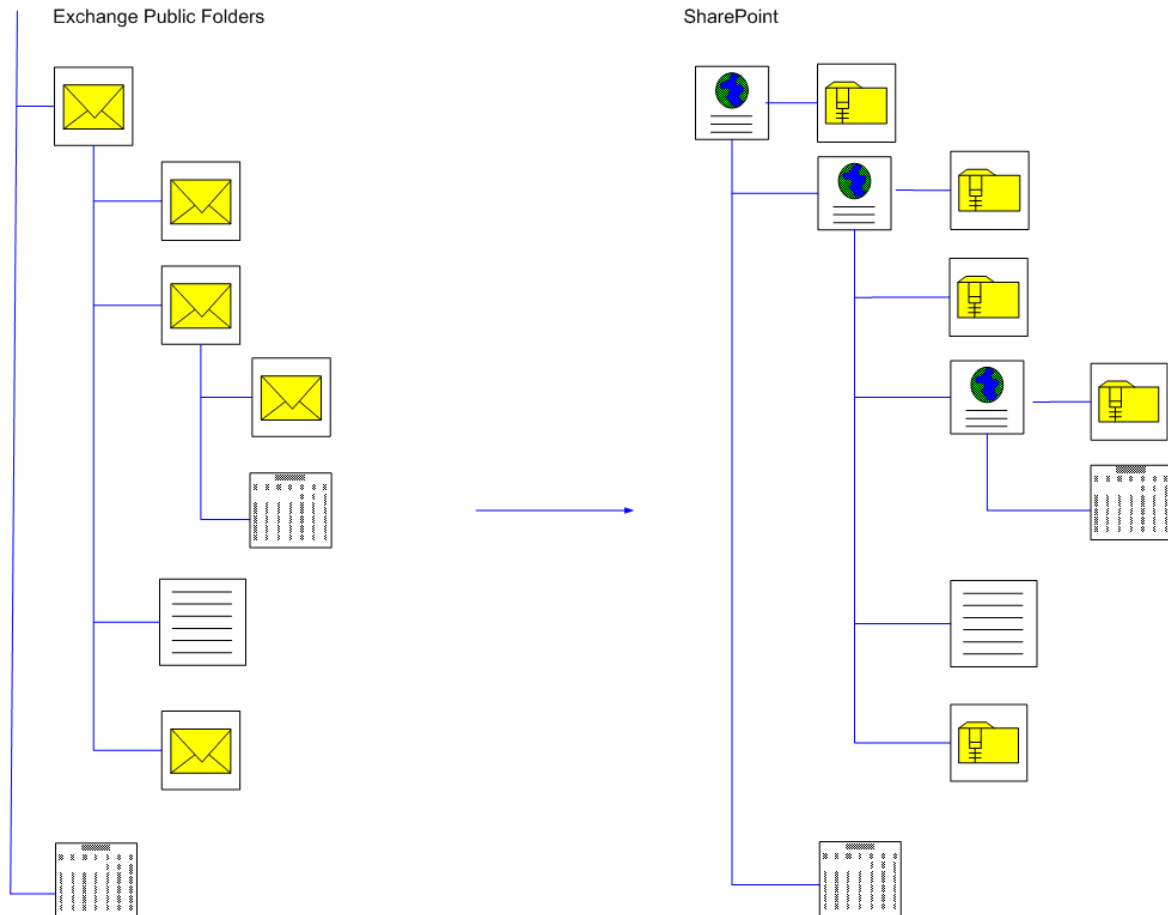

Where:

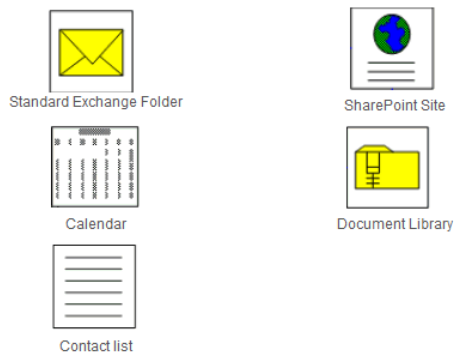

Migration Example 3

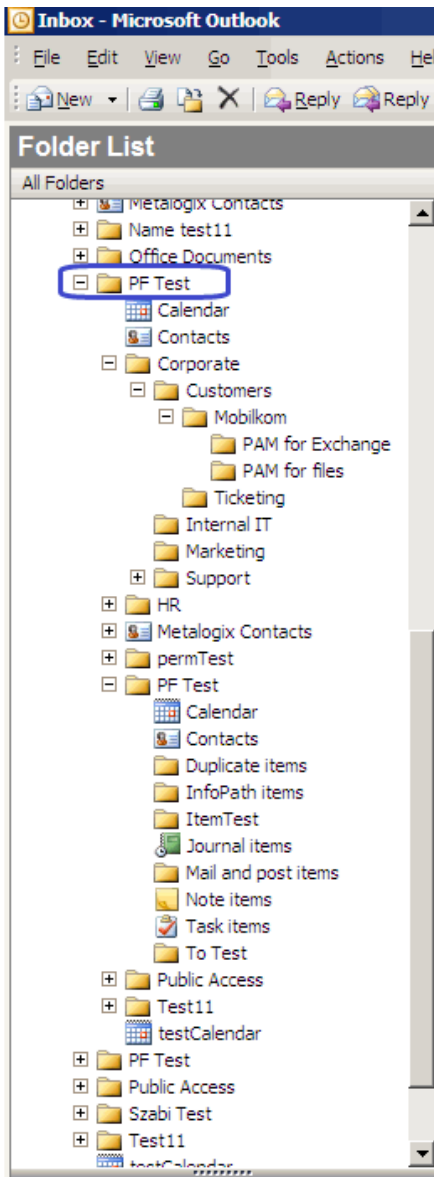

-> Migration using site hierarchy model ->

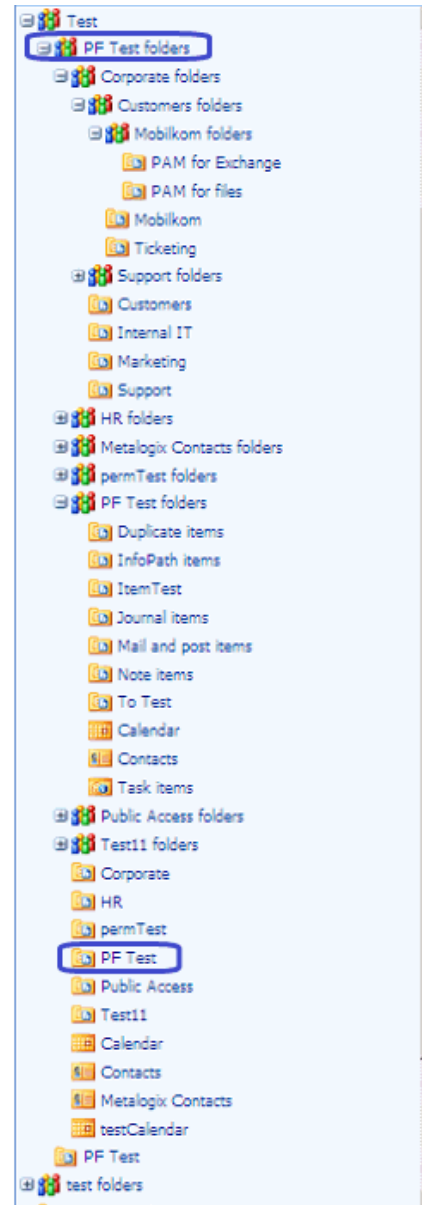

Splitting Large MS Exchange Public Folders

A source Exchange public folder can contain tens of thousands of items. Microsoft recommends not to have more than 5000 items in a single SharePoint container (list or folder) as it can result in degraded SharePoint performance. Content Matrix can automatically split the contents of a large Exchange Public Folders into multiple SharePoint subfolders. Setting the limit of how many items can be migrated into one SharePoint container is an option on the **Paste** settings dialog under the **Hierarchy Options** tab.

Each created subfolder name has its parent's name, plus and the 'Received' or Created date of the first item appended to it, as shown below:

Original Exchange public folder name	SharePoint folder names
--------------------------------------	-------------------------

Company items	Company items\<>date 1> Company items\<>date 2> Company items\<>date 3> ... Company items\<>date n-1> Company items\<>date n>
---------------	--

Performing a Pre-Migration Analysis

You can use pre-migration analysis functionality to analyze all the data intended for migration. Pre-migration analysis will search for incompatibilities which can occur during the migration, and thus help you optimize the migration process, identify the potential migration issues, and get an overview of the content size and item count. It will also estimate the migration speed from the source environment into the target environment, to help you plan the migration.

To run a pre-migration analysis:

1. In **Explorer View**, select the Exchange Connection node for which you want to run the analysis.
2. Right-click and choose **Pre-migration analytics** to display the **Pre-migration analytics** dialog.

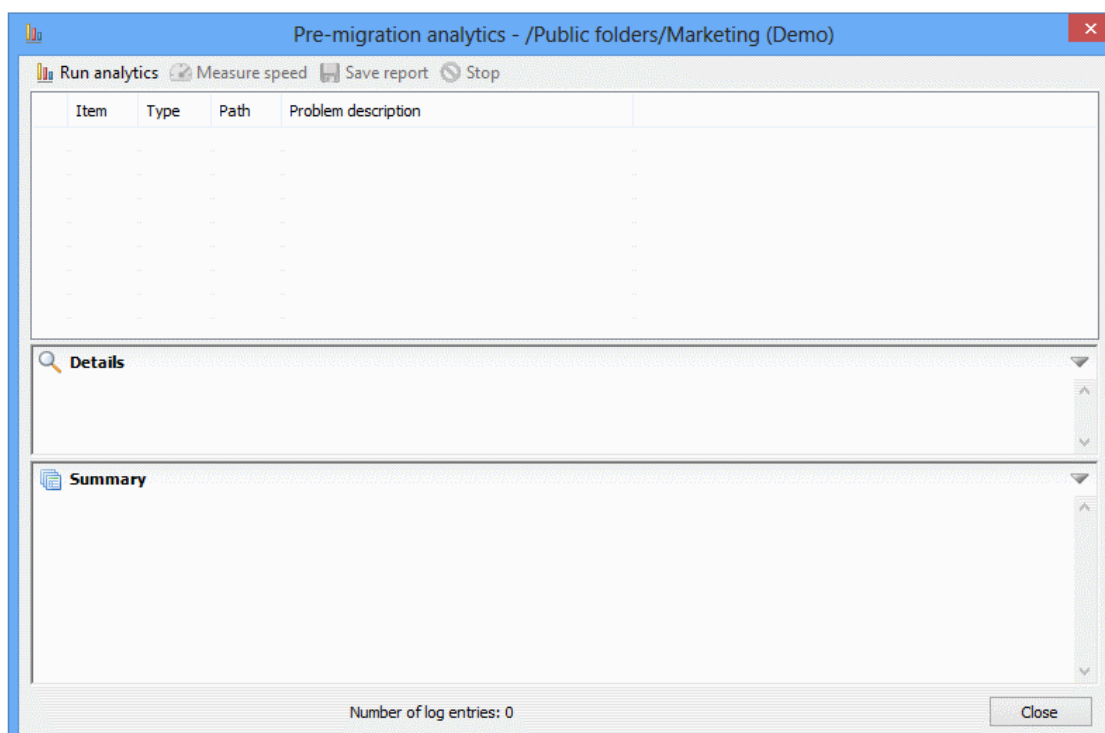

3. Click **Run analytics** in the top left corner to open the **Analytics settings** dialog, to configure the desired settings for the analysis action.

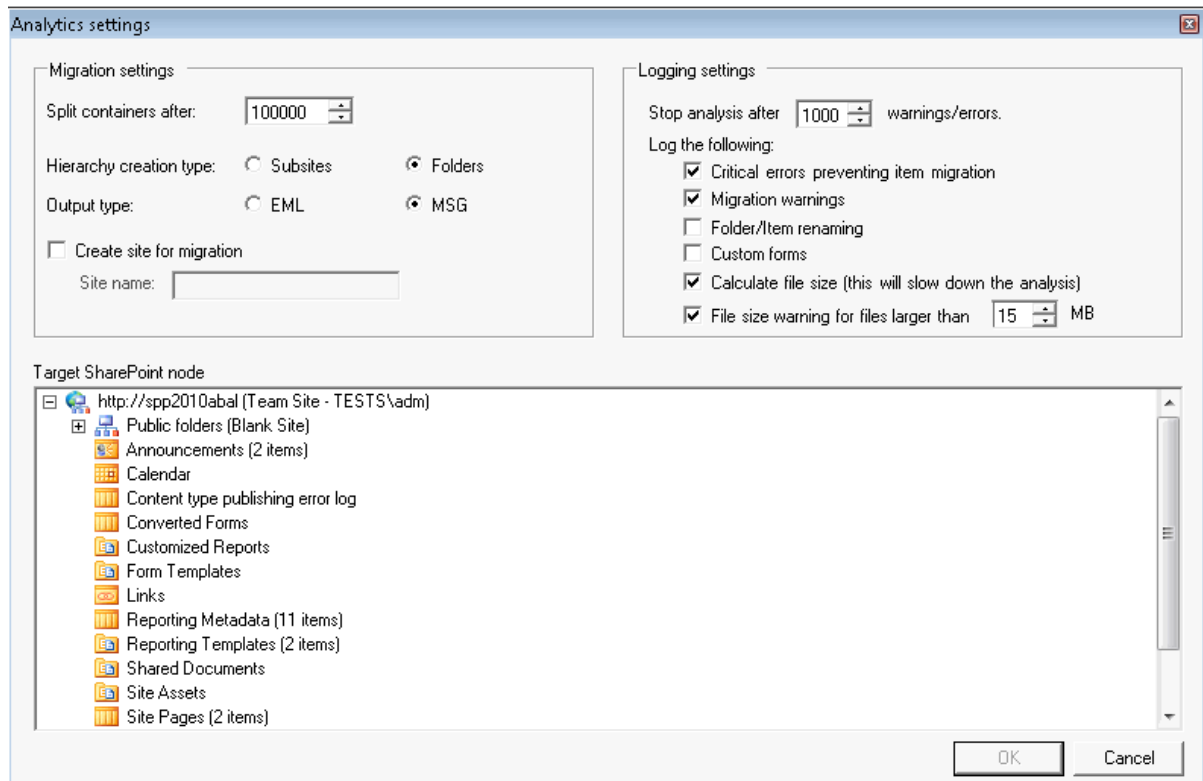

4. Select the **Target SharePoint node** against which you want to run the analysis.
5. Configure the **Migration settings** options as follows:
 - a) If different from the default, specify the maximum number of items the analysis will calculate to be in one container (folder or subsite depending on hierarchy type) by entering a **Split containers after:** value.

NOTE: If the number of items exceeds the defined limit, a new container will be "created" and the analysis will continue.
 - b) For **Hierarchy creation type**, select whether you want Content Matrix to:
 - "create" **Subsites** under the target for new hierarchy levels

OR

 - "create" **Folders** for new hierarchy levels.
 - c) For **Output type**, select the output format you want to use for analyzing items.

NOTE: The EML format is only possible using the EWS connection type.
 - d) If you want the creation of a new target site to be included in the analysis:
 - Check the **Create site for migration box**, and
 - specify a **Site Name**.
6. Specify the applicable **Logging Settings Options**:
 - a) If different than the default, specify a **Stop analysis after "x" warnings/errors** limit, which is the number of warnings/errors that can occur within logs before the analysis will stop.

b) Check the applicable **Log the following:** boxes. Use the information in the following table for guidance.

If you want Content Matrix to ...	Then ...
log critical errors	check the Critical errors preventing item migration box.
log warnings	check the Migration Warnings box.
log folder/item renaming warnings	check the Folder Item renaming box.
log Exchange custom forms published into public folders	check the Custom forms box.  This option is not supported for a MAPI connection to Exchange Server (all versions) or an EWS connection to Exchange Server 2007.
calculate the size of files as well as the average item size	Calculate the file size (will slow down the analysis) box. NOTE: This option is required if you want to Estimate the migration speed and will slow down the analysis
log files larger than a specified size	<ul style="list-style-type: none"> • check the File size warning for files larger than "x" box, and • if different than the default, specify the file size (in MB).

7. Once all of the desired settings are selected in the Analytics settings dialog, click **[OK]** to continue.

The analysis will now run. The Pre-migration analytics dialog will show that it is running the analysis in the bottom left-hand corner, and will list the number of log entries next to the analysis (at the bottom).

You can stop the pre-migration analysis by clicking the **Stop** button in the top right corner of the dialog.

When the analysis is complete the results will be populated in the items grid, **Details** section and **Summary** section (these sections can be expanded by clicking the "up" arrow on the far right-hand side of the dialog, on the same line as each title). Problematic items are displayed with a warning icon. In these cases you can find more details in the Details section.

Expand the Summary section to read the summary information on content size, its count etc.

To estimate migration speed:

NOTE: If you chose to Calculate the file size when configuring the pre-migration analysis, a confirmation dialog displays after the analysis has run, prompting you to estimate the migration time based on configured settings.

1. When prompted, click **[Yes]** to estimate the migration time.

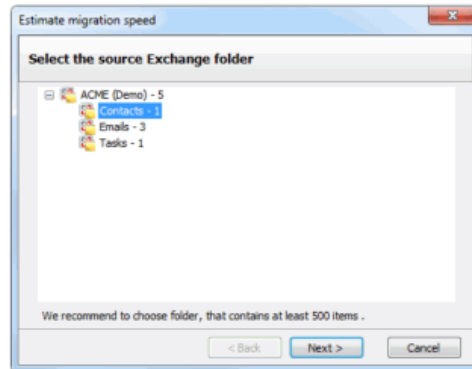

2. Select the source Public Folder for which you want to estimate migration speed.

This window includes only Public Folders that exist under the Public Folder connection originally selected for the pre-migration analysis. It is recommended that users select a folder that contains at least 500 items, but any folder can be selected.

3. Click **[Next]**.
4. Select the target SharePoint node.
5. Click **[Next]** to **Estimate migration speed** dialog

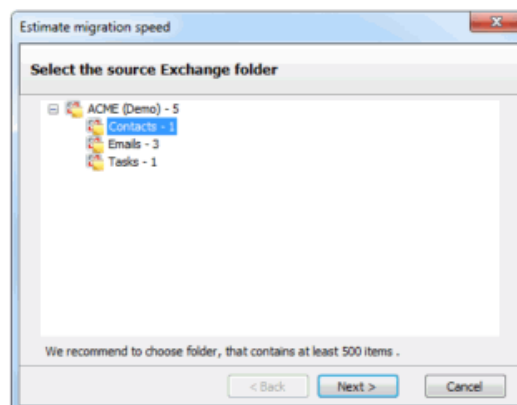

6. Click **[Start]** to begin the estimate.

When the speed estimate runs, results are displayed, in progress, in the window. The progress bar displays the analysis percentage that is complete.

7. When the process finishes, click **[OK]**. Users can see the estimated migration speed in the final dialog.

If you return to the **Pre-migration analysis** dialog, you can expand the **Summary** section, you can view pre-migration analysis results with an estimated time to complete migration of the public folder.

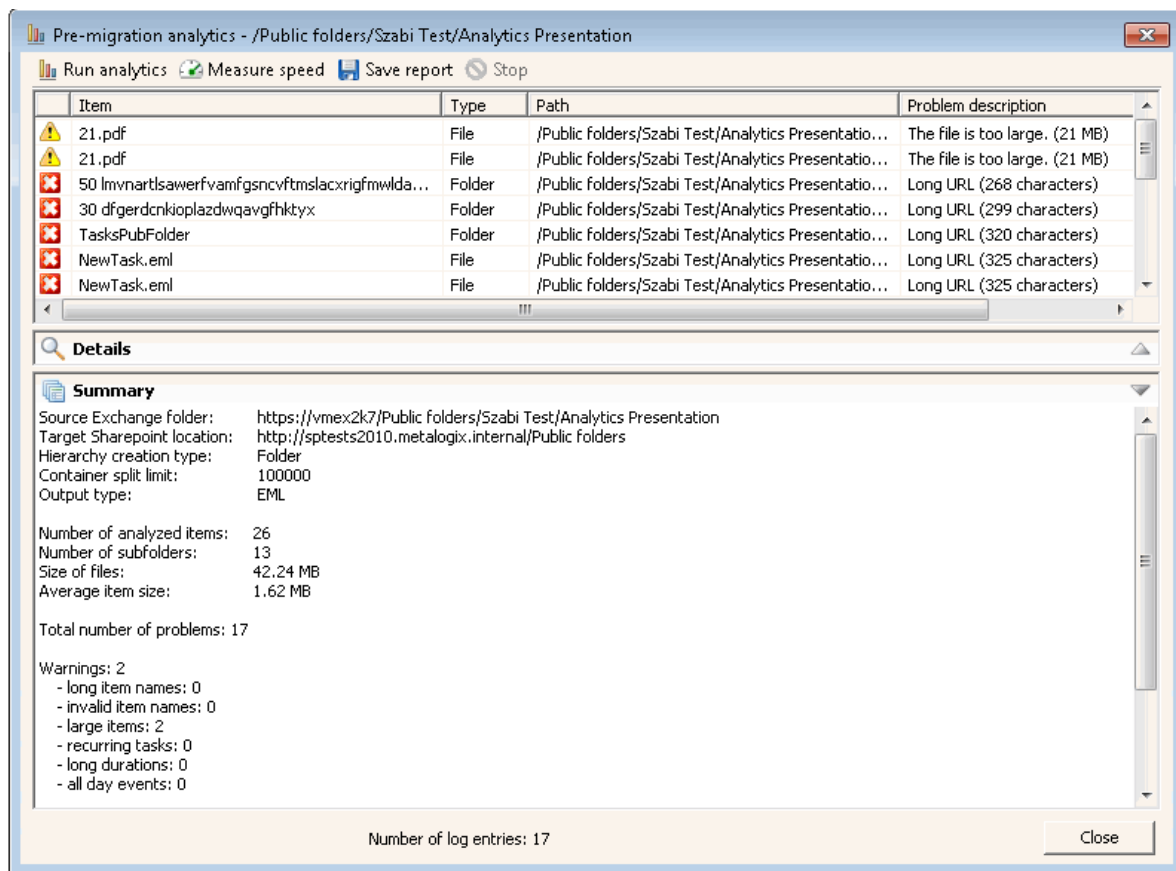

Creating a SharePoint Object

You can create new SharePoint site collections, sites, folders, and lists via the Content Matrix Console.

Creating a SharePoint Site

You can create a new SharePoint site via Content Matrix under an existing site collection or site except for Database connections and the new site can use any site template that is installed on the SharePoint environment.

To create a new SharePoint site:

1. In the Explorer View, select the site collection or site under which you want to create the new site.
2. Right-click and choose **Create Site**.

The Create Site dialog displays, prompting you to enter the **Site Title**, **Site URL Name**, **Description**, and **Template** for the new site.

NOTE: For **Site URL Name**, it is only necessary to enter the name of the site as you want it to appear in the URL, not the entire URL path.

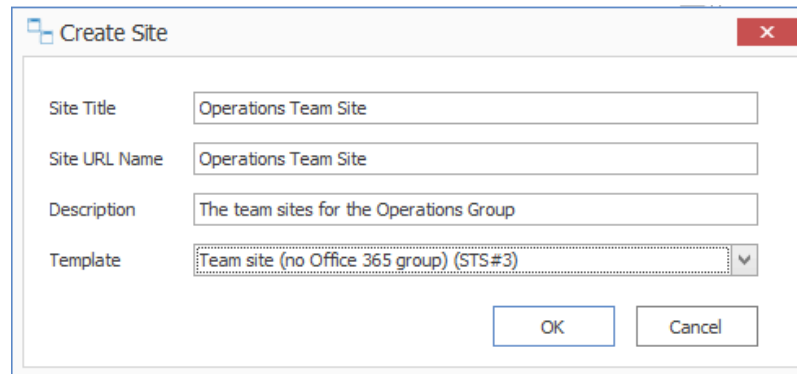

Note that if you are migrating to SharePoint Online or SharePoint 2019, the default template is (modern) **Team Site (no Microsoft 365 group)**. For SharePoint Online, Content Matrix does not support connections to tenant-level groups.

3. When you have completed the fields on the Create Site dialog, click **[OK]**.

The new site will now display in **Explorer View**.

Create SharePoint Site Collection

You can create new site collections on a target SharePoint environment for any SharePoint connection type, except for database and site connections.

To create a new SharePoint site collection:

1. In the Explorer View navigate to the SharePoint Farm/ Web Application (on premises) or Tenant (SharePoint Online) where the new site collection should be created.
2. Right-click and choose **Create Site Collection**.
3. Complete the fields on the Create Site Collection dialog for the selected Mode as you would if you were creating a site collection from within SharePoint.

NOTE: In addition, you have the option to create a host named site collection using the Host Header option. Refer to the [Microsoft TechNet article](#) details about host-named site collections.

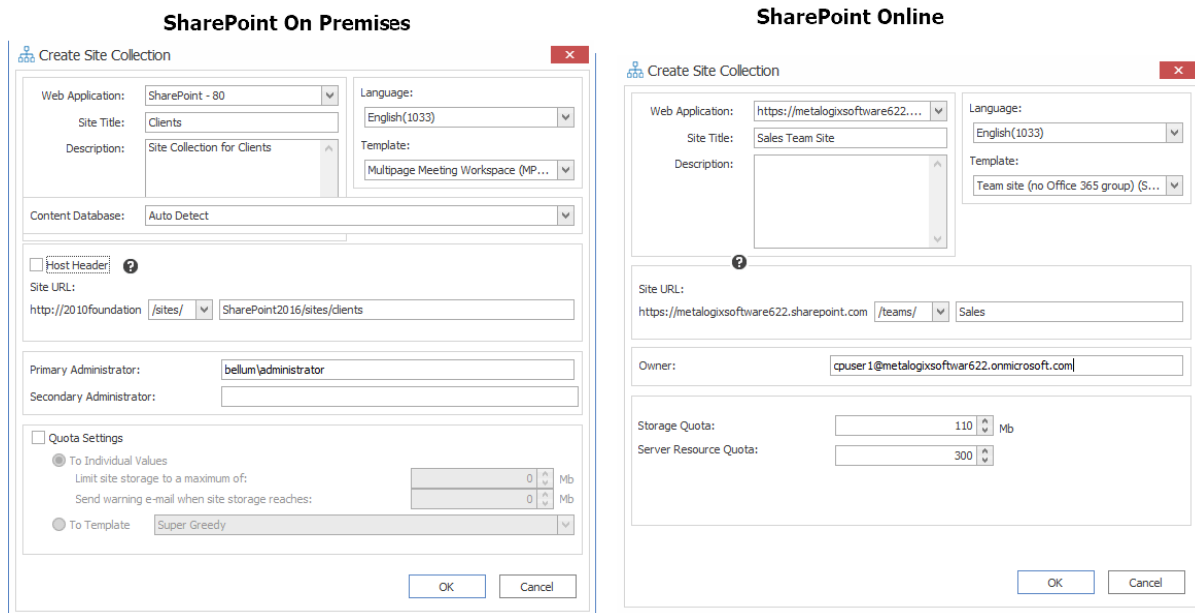

Note that if you are migrating to SharePoint Online or SharePoint 2019, the default template is (modern) **Team Site (no Microsoft 365 group) (STS#3)**. For SharePoint Online, Content Matrix does not support connections to tenant-level groups.

4. After completing the dialog, click **[OK]**.

The new site collection now displays in the Explorer View.

Create a SharePoint List

You can create a new SharePoint list via Content Matrix under an existing site as long as:

- the connection type is not read-only, and
- the new list can use any site template that is installed on the SharePoint environment.

If site creation is not valid for the connection type, the option will be disabled.

To create a new list:

1. Navigate to the SharePoint Site where the list/library should be created.
2. Right-click and choose **Create List**.

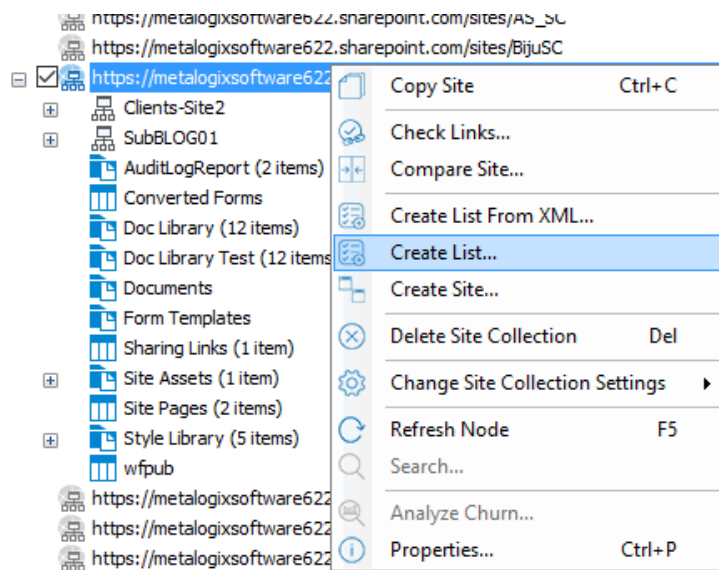

3. Complete the Create List dialog as you would if you were creating a list from within SharePoint.

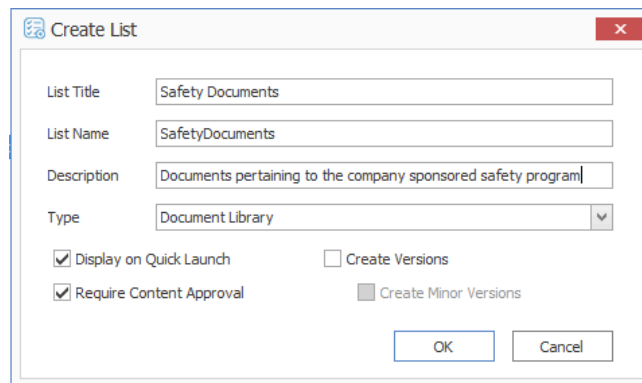

4. After completing the dialog, click [OK].

The new site collection now displays in **Explorer View**.

Create SharePoint Folder

You can create a new SharePoint list via Content Matrix under an existing list or library (or within an existing folder) as long as the connection type is not read-only. If folder creation is not valid for the connection type, the option will be disabled.

To create a new SharePoint folder:

1. Navigate to the SharePoint Document Library, List, or Document Folder under which the new folder should be created.
2. Right-click and choose **Create Folder**.

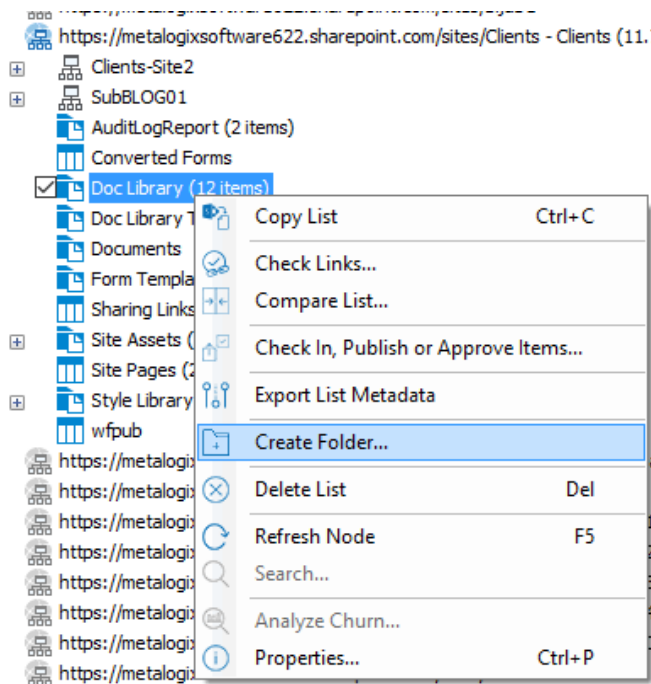

3. Complete the **Create Folder** dialog.

Note that the Folder Type drop down allows you to select the content type with which to create the folder. If only one content type exists on that list/library/folder, the option will be grayed out. There is also a check-box option to overwrite any existing folder that uses the same folder name at the level the folder is being added.

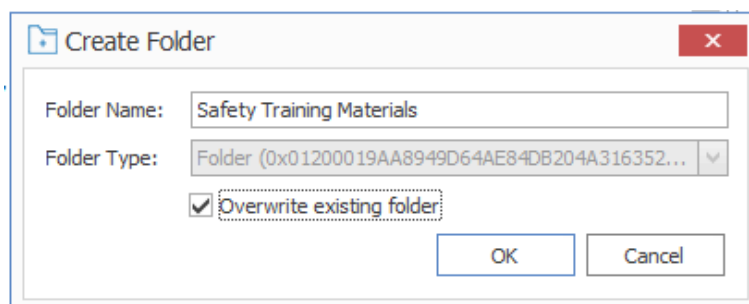

4. After completing the dialog, click **[OK]**.

The new folder now displays in **Explorer View**.

Deleting SharePoint Objects

You can delete one or more SharePoint objects via Content Matrix as long as the connection type is not read-only. SharePoint objects that can be deleted via Content Matrix are:

- SharePoint Sites
- SharePoint Lists
- SharePoint Document Folders
- SharePoint Documents

- SharePoint List Items

If the action is not valid for the connection type, it will be disabled.

NOTE: Document versions and list item versions cannot be deleted via Content Matrix.

To delete one or more SharePoint Objects:

WARNING: When this action is used at the site level or below, the object will be deleted permanently (i.e., it will not be sent to the Recycle Bin). However, a pop-up dialog will display that allows you to cancel the action.

1. Select the SharePoint object(s) to be deleted.

NOTE: Depending on the type of object, this may be in the Explorer View or in the Items View.

2. Either:
 - **Press the Delete key on the keyboard.**
 - **Right-click on the object and choose **Delete [Object]**.**

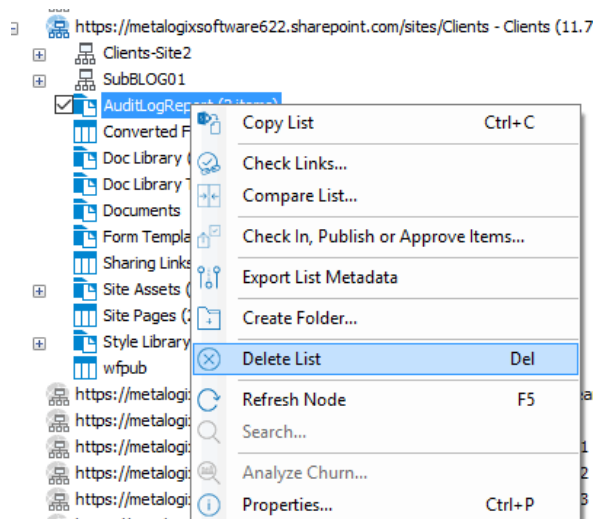

You will be prompted to confirm the action before continuing.

Initiating a Migration

From the Content Matrix Explorer View, you can "copy" an object from the source connection then "paste" it to the appropriate location on the target connection. You will then be prompted to [configure Copy Options](#).

You can migrate one or more [Exchange folders](#) or individual [Exchange items](#), or [migrate Exchange emails directly into a SharePoint Online document library](#).

Migrating Exchange Folders

You can use Content Matrix to migrate Exchange Public Folders to SharePoint. You can migrate entire public folder hierarchies or all items within folders and subfolders.

Some restrictions apply when migrating, Exchange content to SharePoint. For example, calendar items can only be migrated to SharePoint calendars, etc.

To initiate an Exchange Folder migration:

1. In Explorer View, select the Exchange folder(s) you want to migrate.

NOTE: Multi-selection is possible as long as you select nodes at the same level.

2. Right-click and choose **Copy Exchange Folder**.

3. Select the SharePoint node(s) to which you want to paste the content.

NOTE: You can migrate to multiple SharePoint target locations. Right-click the target node and select the option. In case you do not want to create a new SharePoint container, you can migrate all items from an MS Exchange Public Folder to an already existing SharePoint list or folder, by selecting the option.

4. Select the appropriate Paste option. Use the information in the following table for guidance.

If ...	Right-click and choose ...
you want Content Matrix to create a new target SharePoint container as part of the migration	Paste Exchange Folder To List.
you want to migrate the Exchange Folder(s) to an existing SharePoint list or folder	Paste All Exchange Folder Items.

If ...	Right-click and choose ...
	NOTE: This action will migrate all items inside the source folder and all of its subfolders.

Continue with [Configuring Copying Options](#)

Migrating Individual Exchange Items

You can migrate individual Exchange Public Folder items into an existing SharePoint folder.

Some restrictions apply when migrating, Exchange content to SharePoint. For example, calendar items can only be migrated to SharePoint calendars, etc.

To migrate individual Exchange items:

1. In **Explorer View**, select Exchange folder containing the items you want to migrate.
2. Switch to **Items View**.
3. Select the Exchange item(s) you want to migrate.
4. Right-click and choose **Copy Exchange Item**.
5. Select the target SharePoint target list or folder.
6. Right-click and choose **Paste Exchange Items**.

Continue with [Configuring Copying Options](#).

Migrating Emails Directly into a SharePoint Online Document Library

You can migrate Exchange emails directly into a document library that has been created either in SharePoint Online or in the Content Matrix Console.

NOTE: This option is not available when migrating to SharePoint on premises.

Before you can choose a **Paste** operation, Content Matrix must first add the following **Exchange Columns** to the library:

- From
- Subject
- Received
- Item Class
- To

- CC
- BCC
- ReplyTo

To migrate Emails directly into a SharePoint Online Document Library:

1. Select the [email folder](#) or [individual email items](#) you want to migrate.
2. Right-click and choose the appropriate option (**Copy Exchange Folder** or **Copy Exchange Item**).
3. Select the target document library.
4. Right-click and choose **Add Exchange Columns**.
5. When Content Matrix has finished adding the columns to the library, right-click and choose the appropriate option (**Paste Exchange Folder** or **Paste Exchange Item**).

Continue with [Configuring Copying Options](#).

Configuring Copying Options

The **Paste [Object]** dialog provides a tabbed interface that enables you to configure a migration according to your specifications. Available tabs will vary based on the type of migration that you initiated.

Hierarchy Options

You can migrate your source Exchange Public Folder hierarchy to the target SharePoint environment as part of a basic migration. You can also create a sub-site/sub-folder hierarchy based on the number of items in each Public Folder "container."

NOTE: Content Matrix supports target URLs for Public Folders migrated to SharePoint Online of up to 400 characters, which is the maximum length that SharePoint Online allows.

See [Creating a Target Hierarchy](#) for more details.

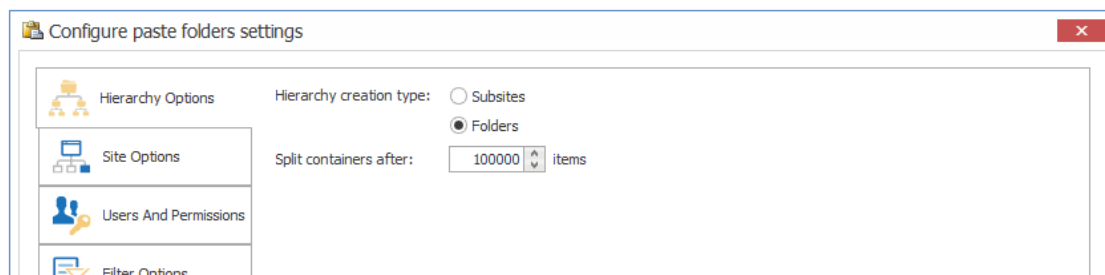

To configure Hierarchy Options:

1. Choose the appropriate **Hierarchy creation type**; that is, whether you want Content Matrix to create the folder hierarchy under the target SharePoint node as:
 - **Subsites**

OR

 - **Folders**
2. For **Split containers after:**, specify the maximum number of items to be migrated into one container (a document library, folder, etc.).

NOTE: If the number of items in the source container exceeds the number specified, Content Matrix will create a new container at the same level.

Site Options

If you are migrating folders into a site, use the Site Options tab to specify how you want a newly created site to be configured.

NOTE: This tab will not display if you are [migrating emails directly into a SharePoint Online document library](#).

To configure Site Options:

Configure paste folders settings

Site Options

- Create site for migration
 - Site name:
 - Show site in parent navigation
 - Site template:
- Enable tree view on sites
- Use SPO Container Office 365 Upload

Open Existing Job Configuration Save Job Configuration Run Save Cancel

1. Check the **Create site for migration** box to have a new site created under the selected target SharePoint node.
2. For **Site name**, enter the display name text as the display name that you want to use for the newly created SharePoint site.
3. If you want the newly created site to be included in the navigation settings of the parent SharePoint site, check the **Show site in parent navigation** box.
4. Select an available **Site template** for the new site from the drop-down.
5. If you want the SharePoint site to use the tree view setting in the quick launch navigation (left-hand navigation) for the new site, make sure the **Enable tree view on sites** box is checked.
6. If you have connected to a SharePoint Online site and want to migrate using [SPO Containers](#), make sure the **Use SPO Container Microsoft 365 Upload** box is checked.

NOTE: If you are migrating to a SharePoint on premises environment, this box will be disabled.

Users and Permissions Options

Users And Permissions Options enable you to map Exchange user accounts and permissions (such as Author, Reviewing Author, etc.) to SharePoint user accounts and permissions (such as Full Control, Contribute, Read, etc.). This means that an Exchange user account can be mapped into a SharePoint user account.

IMPORTANT: Users from the source can only be mapped to the SharePoint target if there is some kind of shared authentication method (such as Active Directory) between them.

If no mappings are specified for any user based metadata that is migrated, Content Matrix will use the migrating user account for this metadata instead.

To configure User and Permissions Options:

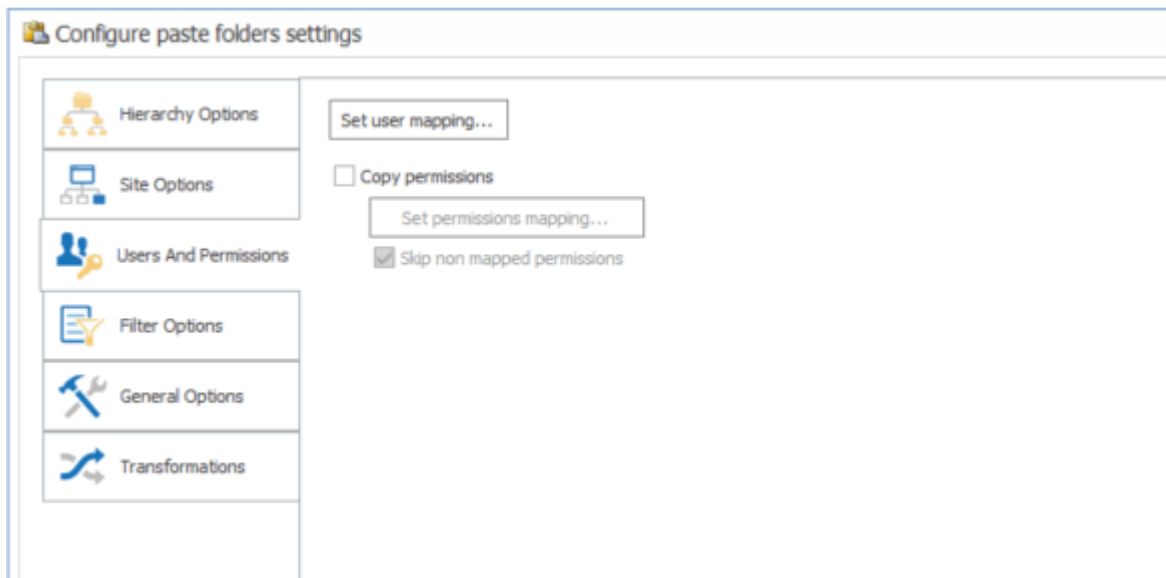

1. Click **[Set user mappings...]** to display the **User Mapping** dialog, and follow the procedure for [Mapping Users and Permissions](#).
2. If you want to copy user permissions:
 - a) Check the **Copy permissions** box.
 - b) If you want to explicitly map permissions between source and target, click **[Set permissions mapping]** and follow the procedure for [Mapping Users and Permissions](#).

NOTE: If you choose not to map permissions, Content Matrix will be use [Automatic Permissions Mapping](#).
 - c) If you want any permissions that are not explicitly mapped to be skipped, check the **Skip non-mapped permissions** box.

NOTE: If this box is not checked, Content Matrix will be use [Automatic Permissions Mapping](#) for permissions that are not explicitly mapped.

Mapping Users and Permissions

You can explicitly map users and permissions when you click the **[Edit Users]** or **[Edit Permissions]** button from the [Users and Permissions tab](#).

NOTE: If the source environment has a large number of users, it is recommended that the [XML user mapping method](#) be used instead, to help improve performance, and for better control over user mapping.

To map user and permissions:

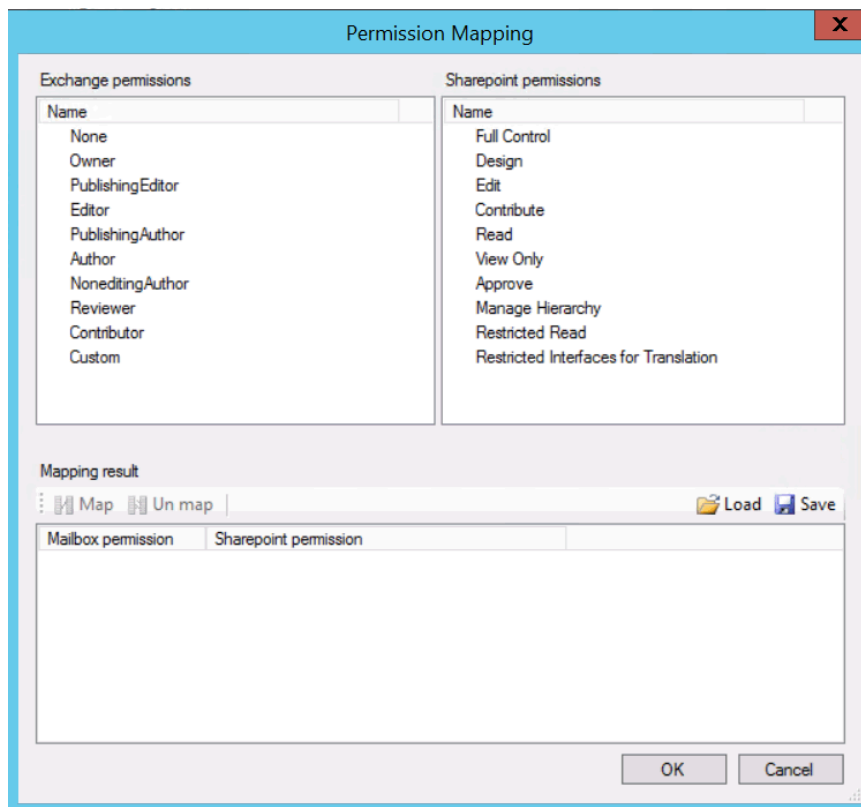

1. Use the information in the following table to determine the appropriate action to take.

NOTE: You can **Filter** items in each window to narrow displayed lists.

If ...	Then...
you want to load mappings from a previously-saved xml file	click the Load icon.
you want to manually map individual users or permissions on the source to a target SharePoint user or permission	<ul style="list-style-type: none"> • From the source list, select the Item that you want to map. • From the target list, select a target Item. • Click the Map icon.

If ...	Then...
<p>you are mapping <i>users</i> and want to have Content Matrix automatically map source users to target SharePoint users (based on email address)</p>	<ul style="list-style-type: none"> From the User Mappings dialog - source list, select the Item(s) that you want to map. Click the Auto icon. <p>NOTES:</p> <ul style="list-style-type: none"> The Exchange From field will be mapped to the SharePoint Created by field. The Exchange Last modified by user field will be mapped to the SharePoint Modified by field. If a user has already been mapped during a migration, the SharePoint Created and Last Modified fields are maintained on the target.
<p>save mappings in the dialog as an xml file</p>	<p>click the Save icon.</p>

The mappings you create will display in the bottom window. (Note that you can also **Unmap** individually-selected mappings in the bottom window or or **Clear** all mappings from the bottom window.

- Click **[OK]** to return to the [Copy Options dialog](#).

Importing Mappings from an xml File

Content Matrix can import any desired user or permissions mappings from an XML file. Importing user or permissions mappings from an XML file involves creating an XML file with the desired mappings, then importing that file. This option is generally used if migrating from an environment that has a large number of users and/or permissions

Example Permission mapping XML

```
<?xml version="1.0" encoding="utf-8"?>
<StaticMaps>
<Map ExPermission="Owner" SpPermission="Full Control" />
<Map ExPermission="NoneditingAuthor" SpPermission="Read" />
</StaticMaps>
```

There could be more Mapped sections within the root StaticMaps section of the XML file. Each Map section defines mapping for Exchange permission into SharePoint permission.

ExPermission - Exchange permission (mandatory)

SpPermission - SharePoint permission (mandatory)

Example User mapping XML

```
<?xml version="1.0" encoding="utf-8"?>
<StaticMaps>
<Map ExUser="adm@tests.local" SpUserDisplayName="adm"
SpUserEmail="adm@tests.local" SpUserIsGroup="False"
SpUserLoginName="TESTS\adm" />
<Map ExUser="test02@tests.local" SpUserDisplayName="test02"
SpUserEmail="test02@tests.local" SpUserIsGroup="False"
SpUserLoginName="TESTS\test02" />
<Map ExUser="test03@tests.local" SpUserDisplayName="test03"
SpUserEmail="test03@tests.local" SpUserIsGroup="False"
SpUserLoginName="TESTS\test03" />
<Map ExUser="test05@tests.local" SpUserDisplayName="test05"
SpUserEmail="test05@tests.local" SpUserIsGroup="False"
SpUserLoginName="TESTS\test05" />
</StaticMaps>
```

There could be more Map sections within the root StaticMaps section of this XML. Each Map section defines mapping of Exchange user (or distribution list) into SharePoint user (or group).

- **ExUser** - Exchange user or distribution list email address (mandatory).
- **SpUserDisplayName** - SharePoint user display name (optional).
- **SpUserEmail** - SharePoint user email address (optional).
- **SpUserIsGroup** - group flag whether SharePoint user is a group (optional, default value set to "False").
- **SpUserLoginName** - SharePoint user login name or the group name in case of group (mandatory).

Automatic Permissions Mapping

When you [Configure Users and Permissions Options](#), you can either map user permissions explicitly, or have Content Matrix map permissions automatically, as specified in the following table.

NOTE: Custom permission groups will be created in SharePoint.

	Owner	Publishing Editor	Editor	Publishing Author	Author	Non-Editing Author	Contributor	Reviewer	None
List permissions									
Manage Lists	X								
Override Check-Out	X	X							
Add Items	X	X	X	X	X	X	X		
Edit Items	X	X	X	X	X				
Delete Items	X	X	X	X					
View Items	X	X	X	X	X	X	X	X	
Approve Items	X	X	X	X					
Open Items	X	X	X	X	X	X	X	X	
View Versions	X	X	X	X	X	X	X	X	
Delete Versions	X	X							
Create Alerts	X	X	X	X					
View Application Pages	X	X	X	X	X	X	X	X	X
Site permissions									
Manage Permissions	X	X	X						
View Usage Data	X	X	X						
Create Subsites	X	X	X						
Manage Web Site	X	X	X						
Add and Customize Pages	X								
Apply Themes and Borders	X								
Apply Style Sheets	X								
Create Groups	X	X	X						
Browse Directories	X	X	X	X	X	X	X	X	X
Use Client Integration Features	X	X	X	X					
View Pages	X	X	X	X	X	X	X	X	X
Enumerate Permissions	X	X	X	X					
Browse User Information	X	X	X	X	X	X	X	X	X
Manage Alerts	X	X	X						
Use Remote Interfaces	X	X	X	X	X	X	X	X	X
Open	X	X	X	X	X	X	X	X	X
Edit Personal User Information	X	X	X	X	X	X	X	X	X
Personal permissions									
Manage Personal Views	X	X	X	X					
Add/Remove Private Web Parts	X	X	X						
Update Personal Web Parts	X	X	X						

Filter Options

Filters can be applied to the migrating content to help limit the content that is migrated. Content Matrix Console uses inclusive filters, meaning that any criteria that meets the set filter will be included in the migration. You can apply multiple filters to a single migration action, and the order in which these filters are applied and be modified.

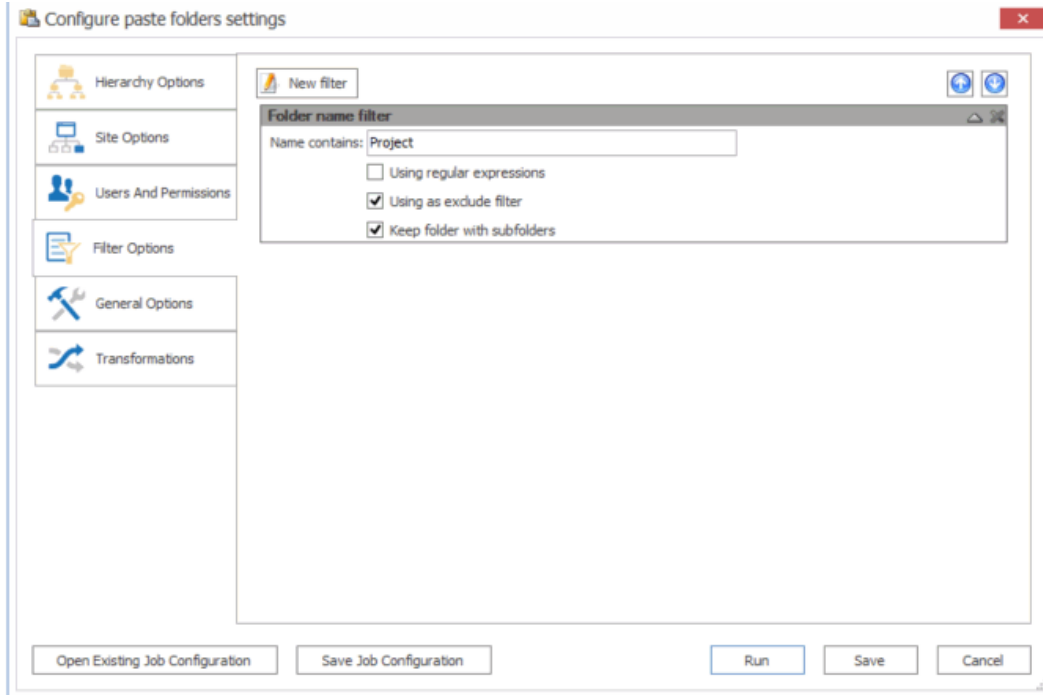

To configure Filter Options:

1. If you want to apply a filter to the migration, click **[New Filter]** to display the **Select Filter** dialog.
2. Select the type of filter you want to apply.
A new dialog displays based on the filter type you selected.
3. Enter the filter criteria that you want to apply to the migration.
4. To apply another filter, repeat steps 1-3.

Note that you can use the up and down arrows ( ) to change the order in which the filters will be applied.

General Options

Use the General Options tab to configure additional options such as logging, item output type, fields to migrate, and column mappings.

To configure General Options:

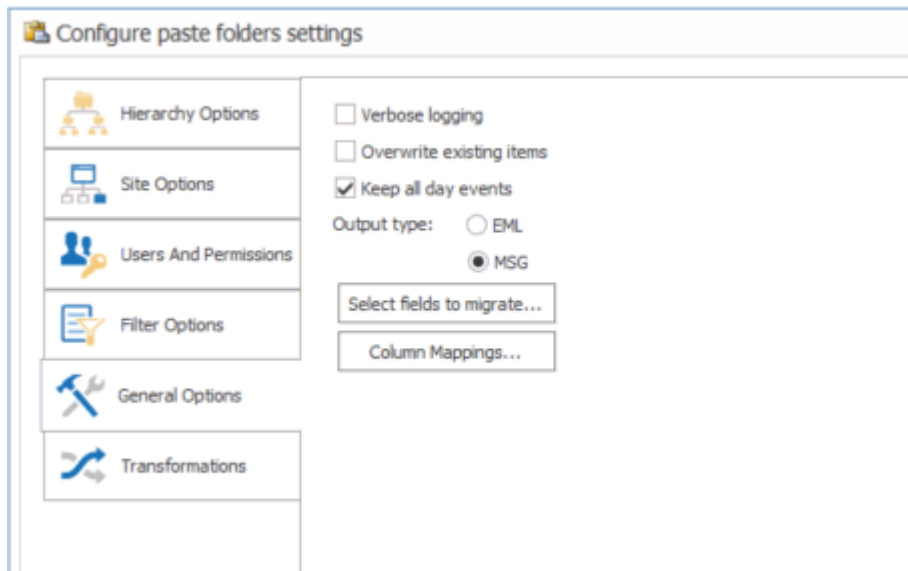

1. If you want more detailed logging for the migration action, make sure the **Enable verbose logging** box is checked.
2. If you want to overwrite any any existing items that have been migrated to the same target location with the same connection adapter type, check the **Overwrite existing items** box.
3. If you want to allow all day events to remain as all day events in SharePoint after the migration, make sure the **Keep all day events** box is checked.

NOTE: If this box is not checked, all day events will be converted to standard (not all day) events with a duration of 24 hours. This conversion is mainly useful if the migration is between systems using different time zones.

4. Select the desired **Output type**. Use the information in the following table for guidance.

NOTE: Exchange folders can be pasted to a SharePoint list or folder only if that list or folder was created by Content Matrix. Some restrictions apply when migrating; for example, calendar items can only be migrated to SharePoint calendars, and so on

If you want to migrate items ...	Then ...
in electronic mail (EML) format	select EML . NOTE: Items migrated in this format do not retain all original MAPI properties of the source Exchange item.

If you want to migrate items ...	Then ...
in message object (MSG) format	select MSG . NOTES: <ul style="list-style-type: none"> • Items migrated in this format to SharePoint open automatically with Outlook, and the email body, header, and any attachments are fully preserved and maintained within a single envelope in one file on SharePoint. • MSG is supported by MAPI, Redemption, and PST connections, but not by an EWS connection.

5. To select the fields to migrate to the SharePoint target:

a) Click **[Select fields to migrate]** to display the **Select Fields to Migrate** dialog.

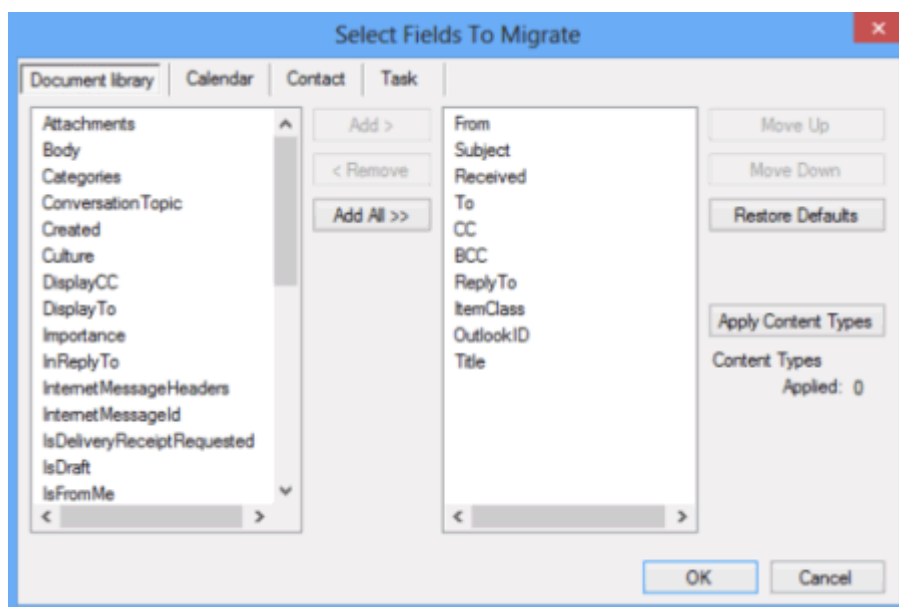

NOTE: In MS Exchange, every item has dozens of properties which can be read and potentially migrated to SharePoint. Most of these properties have little meaning for end users, and are not particularly useful in a SharePoint environment, however, users may want to retain them for historical or audit purposes. Content Matrix Console offers a default set of properties that will automatically be migrated for every list type.

b) Select additional fields to be created and migrated to the target SharePoint site and/or removed from the list.

EXCEPTIONS: The following properties cannot be removed because they are needed for identifying migrated items:

- **OutlookID** - A unique item identifier field that is typically not visible to the end user, in the default SharePoint list or library view.

- **Subject** - A string field that lists the item's subject (i.e. mail subject, document name, calendar item title, etc.)

- c) If you want to apply Content Types to the target list, click **[Apply Content Types]** to display the **Content Type Application Options** dialog and follow the procedure for [Applying Content Types to Lists and Libraries](#).

NOTE: This button is available for each list type (Document Library, Task, Contact, Calendar, etc.). Settings defined for one list type do not affect other list types. The content types specified in the pop-up dialog will be applied to the target list and it will be possible to create items based on this content type in SharePoint (see further).

6. If you want to map source to target columns, click **[Column Mappings]** to display the **Edit Column Mappings** dialog and follow the procedure for [Mapping Columns](#).

Mapping Columns

You can map columns from the source connection into separate columns on the target when migrating content into a SharePoint target.

NOTE: Content Matrix allows one-to-one column mappings. If a source or target column is already used in a mapping, then that column will no longer be available for any other mappings.

The following types of column mappings can be made:

- Standard column mapping, when you click **[Column Mapping]** from the [General Options tab](#)
- Content Type column mapping, when you click the [...] button from the [Content Types Application Options dialog](#).

To map columns:

1. Use the information in the following table to determine the appropriate action to take.

NOTE: You can **Filter** items in each window to narrow displayed lists.

If you want to ...	Then...
manually map each individual source column to a target SharePoint column	<ul style="list-style-type: none"> • From the left (source) window, select the Item that you want to map. • From the right (target) window, select an available Item. • Click the Map icon.
create a new column on the target for any columns that are selected on the source side	<ul style="list-style-type: none"> • From the left (source) window, select the Item that you want to map. • Click the Target icon to display the New Mapping Target dialog. • Enter a Column Name.

If you want to ...	Then...
	<ul style="list-style-type: none"> • If you want the column to be created as a site column, check the Create as Site Column, , and choose a column type from the Group drop-down. • If you want to add the column to a content type that exists on the target: <ul style="list-style-type: none"> ▪ check the Add to content type scoped at target site box AND ▪ select the content type to which you want to add the column from the Type drop down.

The mappings you create will display in the bottom window. (Note that you can also **Unmap** individually-selected mappings in the bottom window or **Clear** all mappings from the bottom window.)

2. Click **[OK]** once all desired mappings have been made and return to the [Configuration Options](#) dialog.

Mapping Items to Content Types

You can specify content types for target items when you click the [...] button from the [Content Type Application Options](#) dialog.

To map items to content types:

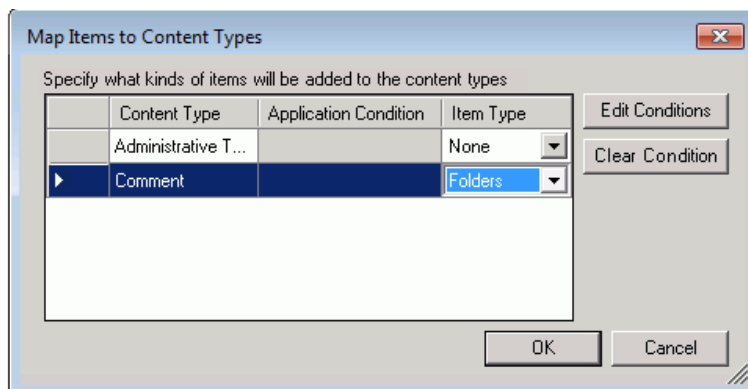

1. Select the content type, and click **[Edit Conditions]** to display the **List Items and Documents Where filter** dialog.
2. Select the filter(s) you want to apply as you would when [applying filters to a migration](#).

NOTE: If you select **[Clear Condition]**, all conditions that are currently applied to that content type will be cleared.

- Once all filters have been set, click **[OK]** to return to the **Content Type Application Options** dialog.

Applying Content Types to Lists and Libraries

You can specify content types for the target list when you click **[Apply Content Types]** from the [General Options - Select Fields to Migrate](#) dialog.

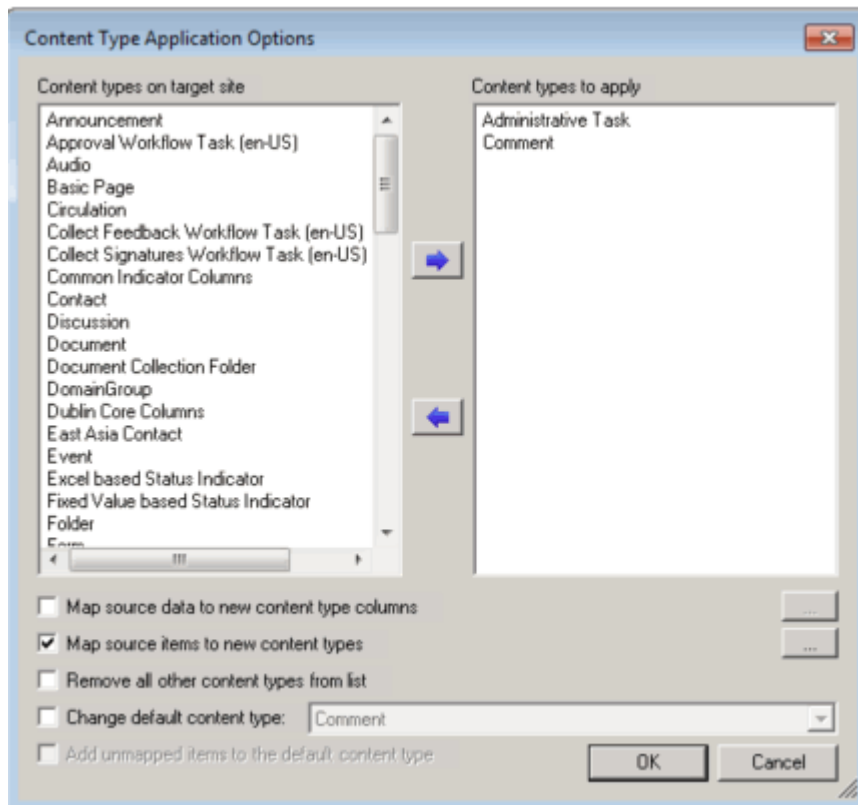

The left-hand window (**Content types on target site**) displays all of the available content types that exist on the target SharePoint instance that can be applied to the target list. The right-hand window (**Content types to apply**) displays all of the selected content types that will be applied to the list.

To apply content types to lists and libraries:

- From the **Content types on target site** window, select all of the content types that you want to apply to the list and move them to the **Content types to apply** window.
- Select any of the remaining options that you want to apply. Use the information in the following table for guidance.

If you want to ...	Then ...
map a content type	A. Check the Map source data to new content type columns box.

If you want to ...	Then ...
column on the source to a column on the target, as the new content type column	B. Click the [...] button to display the Edit Column Mappings dialog. C. Continue with the procedure for Mapping Columns .
map items from the source into a new content type on the target based one or more specified filters	A. Check the Map source data to new content type columns box. B. Click the [...] button to display the Map Items to Content Types dialog. C. Continue with the procedure for Mapping Items to Content Types . NOTE: This option is available only when migrating Exchange folders (not individual items).
change the default content type for the target list or library	A. Check the Change default content type box B. Select a content type from the drop-down. NOTE: When you check this box, the Add unmapped items to the default content type is automatically enabled and checked.

Transformations Options

You can view, create, and edit Transformers which, as the name implies, "transform" content during migration.

There are several built-in, non-editable transformers that Content Matrix uses to process data during the migration. Advanced users can also create custom transformers [using PowerShell](#).

The **Transformations** tab consists of two main sections: **Available Definitions** and **Applied Transformers For <Object>**. The Available Definitions section will list all of the transformation definitions that are available for the current migration action, in alphabetical order. For example, the Site definition is available when migrating at the site level or higher. However, if migrating as a document library or migrating documents, this definition will not be listed.

When one of the **Available Definitions** items is selected, any transformations that exist/have been configured within the migrating content will appear. Some of the actions that may be grayed out. These grayed out items are mandatory transformations that are run during the course of a normal migration, and these actions cannot be edited or removed. However, they can be reordered by using the up and down arrows to the right-hand side of the window if you want a transformation action to occur before a mandatory action. Actions that appear and are not grayed are user added transformations, and can be moved, edited and deleted at the users discretion.

In some cases, you could add another instance of an existing transformer, and then have it run in two different locations within the migration process. One could be run in the middle, and it could be run again just before the end.

Using PowerShell to Create Custom Transformations

When you select the **Add Transformer > Invoke PowerShell script** option for an Available Definition, you can use custom PowerShell scripts to create your own transformations beyond the built-in capabilities of the Content Matrix.

Specify when you want the script to run by selecting one of the following options:

Begin Transformation – The transformation script will run before the migration of the affected objects, allowing you to read and make changes to objects on the source before objects themselves migrate.

Transform – The transformation script will run while the migration of the affected object(s) is in progress. For example, the user mapping between source and target would be run using the Transform option.

End Transformation – The transformation script will run after the migration of affected object(s), allowing you to read and make changes to objects on the target.

EXAMPLE: The following Transformer consists of two scripts for disabling and re-enabling the Required setting for a column list.

- The first script entered into the **Begin Transformation** tab sets the setting of any columns that are Required to false before copying begins.

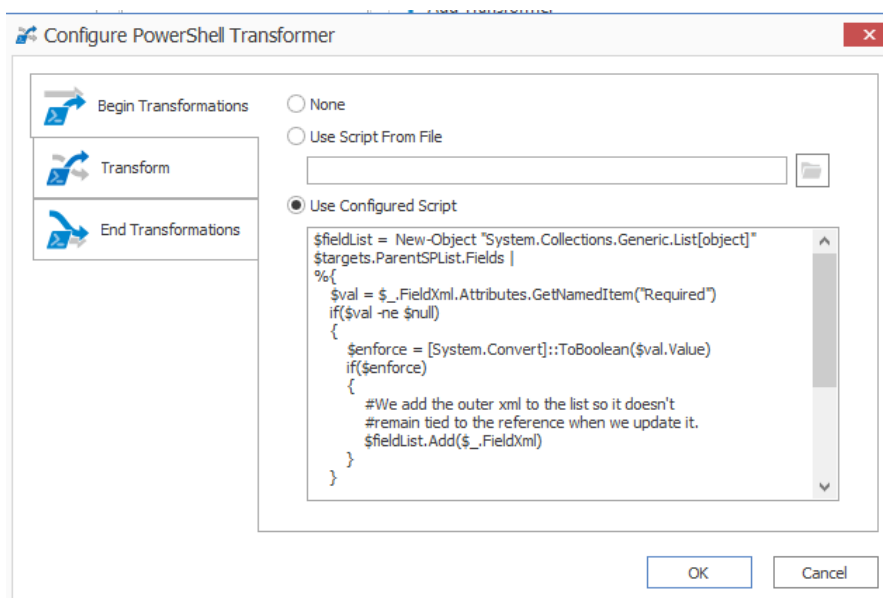

- The second script, entered into the **End Transformations** tab, sets the setting back to true after item migration has completed.

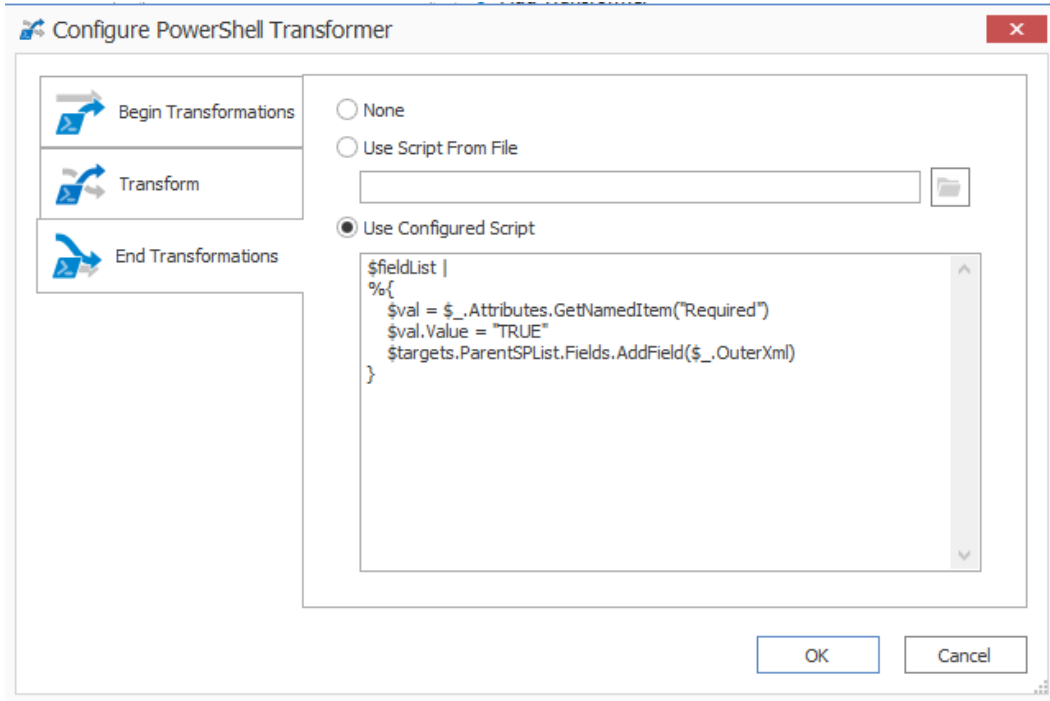

Saving or Running a Migration Action

When you finish configuring a migration action, you can run it immediately or save a copy of the settings to a job file, which displays in the Job List section. You can then:

- run a migration directly from the [Job List](#) section

OR

- [create a PowerShell script](#) and [schedule it to run as a Windows Scheduled Task](#)

OR

- [trigger jobs in the Content Matrix Console to run using PowerShell.](#)

You can also [save the job configuration as a template](#) so that you can preserve and reuse settings for future migration jobs.

When the migration starts, a status dialog box will appear. The [job logs](#) can be viewed (in progress or after the migration is finished) by clicking **[Details>>]**. The Status section of the status box will list a live count for the number of successes, warnings, failures, etc. for the migration. The Progress section of this dialog will list any completions and the type of completion (Sites, lists, items, users, groups, etc.). A Migration Completed message will appear when finished. Click **Close** to exit the status dialog.

Connecting to a Full SQL Job Database

If you are using SQL CE to host your Content Matrix Jobs Database, you will receive a warning in the job log (and as a pop-up if you are running the job from the Console interface).

The use of SQL CE in a production environment is discouraged because of the following limitations:

- It uses a single .list file that is less robust and reliable and may be corrupted after the database reaches 4 GB.
- Data compression is not supported.
- Support for large objects is limited.

To switch to a full-feature SQL Server for the Content Matrix Job Database:

1. From the Job List choose **File > Connect to Job Database**.

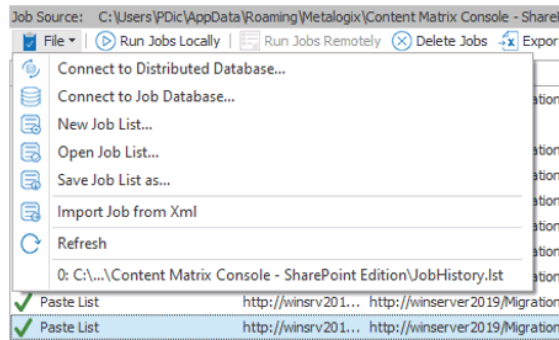

2. Complete the **Connect to SQL Server** dialog:

- If you are connecting to an **on premises SQL database**, create (using the New Database option) or select the database you want to use.

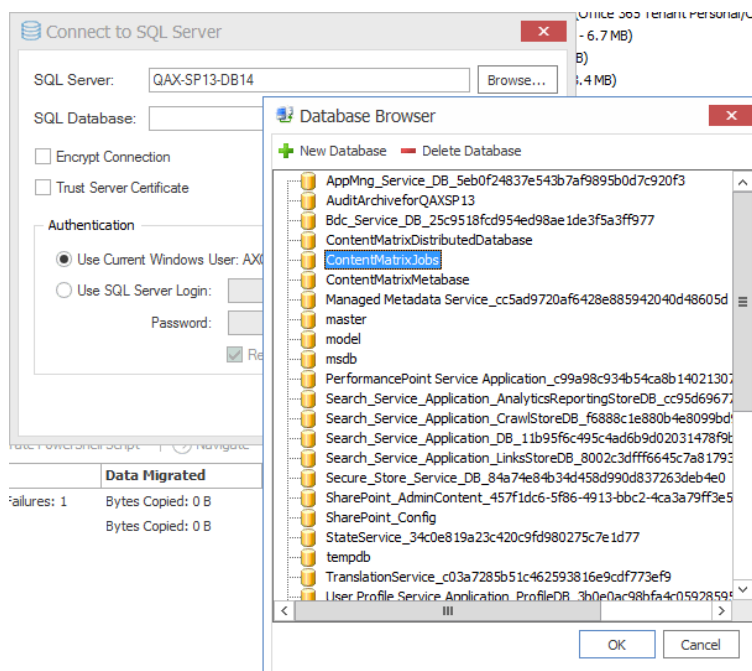

- If you are connecting to an **Azure SQL database**, select the database that has been created in Azure Portal for use by Content Matrix. (Note that the New Database and Delete Database options will be disabled.)

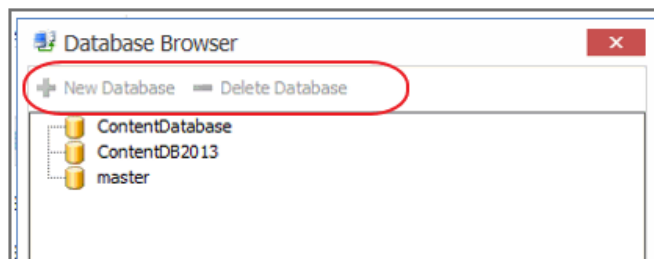

3. If you want to use an [encrypted connection](#) to the database, check the **Encrypt Connection** box.

NOTE: If the certificate used for encryption is not [trusted](#), you will also need to check the **Trust Server Certificate** box.

4. Select an **Authentication** method for connecting to SQL server:

- **Use Current Windows User**

OR

- **Use SQL Server Login**

NOTE: Currently, **Use SQL Server login** is the only valid option for an Azure SQL server.

5. Click **[OK]**.

Saving a Job Configuration as a Template

You can create job configuration templates for a set of selected settings which can be saved and reused, including any options that are not normally preserved using the **Preserve Configuration Options** option (in the ribbon **Settings** menu).

These templates can also be moved to another machine and used with a separate install of Content Matrix Console (provided that it is the same Edition of Content Matrix, and the same version number or greater).

To save a job configuration template:

1. After initiating a migration, complete the [Configure \(Object\) Copying Options](#) with the settings that you want to include in the template.

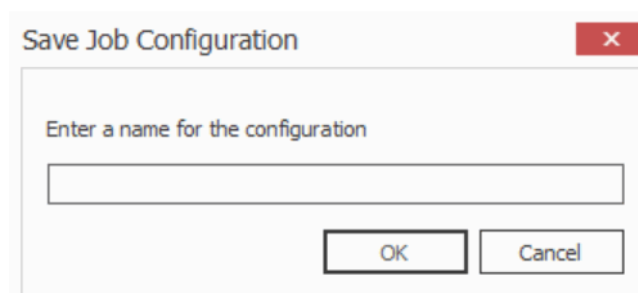

2. Click **[Save Job Configuration]**.

Here you can set the **display name** for the job template. This is **not** the actual file name, but it is the name that Content Matrix will use to list the template.

NOTE: In most cases, when a job template is saved by Content Matrix it will be saved to the following location:

C::\Users\

However, it is highly recommended that you do not interact with this system location. If you are trying to save a job template so it can be [exported](#) to another system the template can be exported from the [Manage Job Configurations](#) dialog.

3. Enter the desired **display name** value and click **[OK]** to continue.

Once the **save** is complete, you will be returned to the **Configure <Object> Copying Options** dialog where the migration can either be **Run** or **Saved**.

The saved job templates will now be visible in the Manage Job Configurations dialog.

NOTE: If you are looking to save a job template and move it to another system for use, this should be done using the [Export](#) option in the [Manage Job Configurations](#) window. Additionally, if you are trying to [Import](#) a job template from another system, this must also be done from either the [Manage Job Configurations](#) dialog or it can be imported when [applying a template](#).

Applying a Job Template

Any job templates that have been [imported](#) or [saved](#), and are available in the [Manage Job Configurations](#) dialog can be applied to another migration of the same type. For example, if migrating at the site level, you would not be able to use a job template that is created for a migration at the list level. It would only be able to use a template that migrates at the site level.

The source and target connection types do not apply directly to a job template, so it does not matter if the connection types for the new migration are the same as the connection types for the job template. If the connection types are different than any options that are not applicable for the connection types that are being used will not be available, but all other options will be set.

1. After initiating a migration, click **[Open Existing Job Configuration]** in the bottom left corner of the **Configure <Object> Copying Options** dialog to display the **Select Job Configuration to Apply** dialog.

NOTE: Any options you have specified directly in the dialog will be overwritten once a job template is applied.

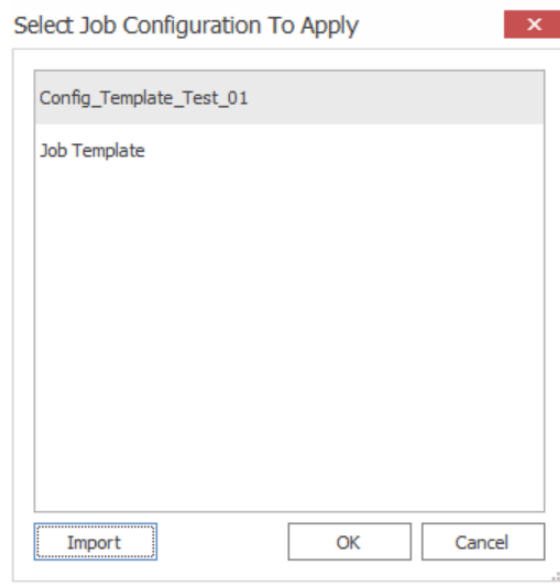

The dialog lists all of the job templates that are currently available for the migration type (i.e. a site, list, item, etc. migration), as well as only the templates for the specific Edition of Content Matrix that is being used.

2. Select the desired job template and click **[OK]**.

You will be prompted to confirm your action before continuing. Remember that if you choose to apply the template, any other settings that you entered directly in the **Configure <Object> Copying Options** will be lost.

The **Configure <Object> Copying Options** dialog will now reflect all of the template options. Any additional configuration options can be set or modified, and the migration can continue as normal.

Managing Job Templates

Content Matrix Console job templates can be managed in the **Manage Job Configurations** dialog. This dialog allows users to **Import**, **Export**, **Delete**, or **Filter** any job templates. Below is a breakdown of the available options in the **Manage Job Configurations** dialog.

- **Import** - This button allows users to Import a job template. The imported job template must be from the same Edition of Content Matrix Console. For example, if users are importing a template into SharePoint Edition then the template must have been exported from SharePoint Edition.
- **Export** - This button allows users to [Export](#) a job template. The export will create an XML file in a desired folder location so the file can be copied and placed into another location as needed.
- **Delete** - This button will **delete** any selected job templates from Content Matrix Console. When deleting a template, a **confirmation** dialog will open and must be confirmed before the templates are deleted. Deleting will **permanently delete** the selected templates from Content Matrix Console.
- **Filter** - This is a text box that allow users to enter a value that Content Matrix will filter the job templates against. The filter will only display items that contain the specified value. There is a Filter icon to the right-hand side of the filter text box. Clicking this icon will apply the filter text value to all of the job templates listed in the **Manage Job Configurations** dialog, so only the templates that contain/include the matching filter value will be shown. Filtering can be cleared by removing the text value from the filter text box and clicking the filter icon button.

Exporting a Job Template

To export a job template:

1. In Content Matrix's ribbon toolbar, switch to the **Settings** tab and click **[Manage Job Configurations]** button to display the **Manage Job Configurations** dialog.

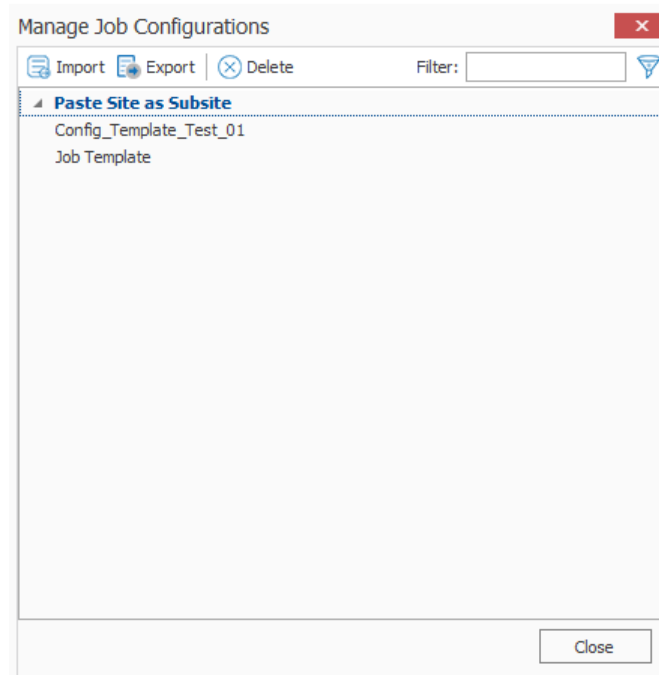

2. Select the template you want to export then click the **Export** button at the top of the **Manage Job Configurations** dialog, .
3. Navigate to the desired folder location where you want to save the job template, enter a **File name**, and click **[Save]**.
4. The job template XML file will be saved to the selected folder location, and Content Matrix will return to the **Manage Job Configurations** dialog. Any additional importing, exporting, or deleting of job templates can be done. Click **Close** to return to the main Content Matrix window.

Now that the job templates have been **exported** and saved to a folder location they can be manually moved to another location as required.

Importing a Job Template

Only templates that have been created from the same Edition of Content Matrix Console can be imported. For example, a job template from SharePoint Edition cannot be used in Public Folder Edition, it can only be imported into SharePoint Edition.

To import a job template:

1. In Content Matrix's ribbon toolbar, switch to the **Settings** tab and click **[Manage Job Configurations]** button to display the **Manage Job Configurations** dialog.

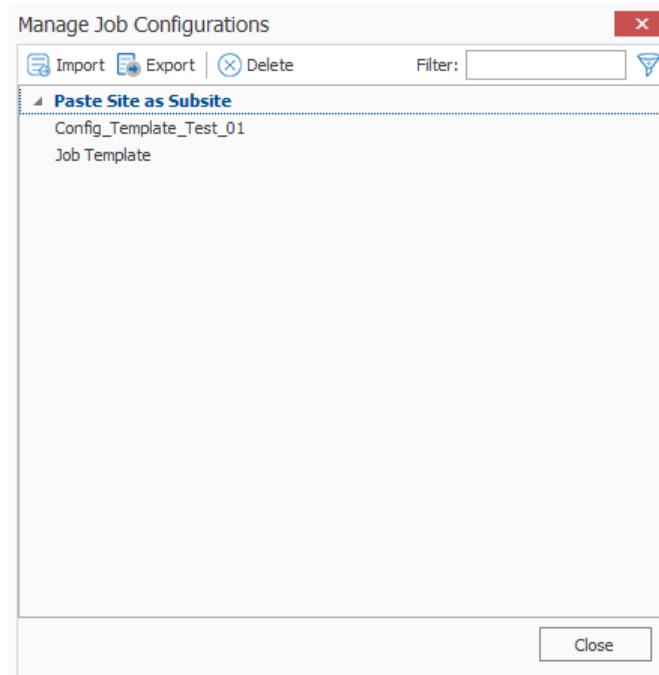

2. Click the **Import** button at the top of the **Manage Job Configurations** dialog, navigate to the folder location for the template XML file, then click **[Open]**.

The job template will be added to the list of templates in the **Manage Job Configurations** dialog. The template will be listed using the same **Display name** that was used when the task was created on the original system and will **not** have its file name displayed.

The job template is now imported and can be [applied](#) to any migration.

Importing and Exporting Migration Jobs Using Xml files

From the Job List, you can export a job to an xml file. This functionality allows you to:

- Copy a job from one instance of Content Matrix to another (as long they are for the same Edition).
- Manually modify a job, then re-import it.

To export a job to an xml file:

1. In the **Job List**, select the job(s) you want to export.

NOTE: If you select multiple jobs, they will be saved to a single xml file.

2. Right-click, and choose **Export selected job to xml**.

The xml file will automatically open in whatever program is set as the default application for xml files, and it can be saved to any desired location.

To import an xml file to the Job List:

1. Make sure the file you want to import uses a different Job ID than any existing jobs (this should only be an issue if the xml file was previously exported from the same Content Matrix Console).

NOTE: If you import an xml file via the Console and the file being imported contains the same Job ID as an existing Job, then the import will fail. However, you can create a duplicate job with a different Job ID if you [import the xml file using PowerShell](#).

2. From the Job List menu, choose **File > Import Jobs From Xml**.
3. Select the xml file to import.

If the import is successful, the job will be listed in the Job List section. If unsuccessful, an error message will be displayed.

Importing Jobs from Xml Using PowerShell

You can import jobs that have been previously [exported to xml](#) using PowerShell.

To access the PowerShell cmdlets for connecting to SharePoint:

Open a PowerShell or PowerShell ISE session and [add the PowerShell snap-ins for the application framework](#).

To import jobs from an xml file:

1. Select (from the PowerShell ISE Command Window) or enter **Load-JobXml**.
2. Select or enter the applicable parameters. Use the information in the following table for guidance.

Parameter	Notes
XmlFilePath (Required)	The path to the xml file containing the job(s) you want to import.
ImportDuplicate (Optional)	<p>If you use this parameter and the job already exists in the Jobs Database, it will be imported with a new Job ID.</p> <p>If you omit this parameter and the job already exists in the Jobs Database, it will not be imported. For an xml file that contains multiple jobs, only those that are not in the Jobs Database will be imported. If trace logging is enabled, the detail will be logged in the file MetalogixGlobalLog.txt.</p> <hr/> <pre>2022-08-24 09.39.51.7569: Error 2022-08-24 09.39.51.7569: User=srishtir, Domain=CYBAGE 2022-08-24 09.39.51.7569: Could not import below Jobs: JobId: 78d256af-96b1-460b-871a-d58e574ce033, Reason: Job with same JobID already exists</pre>

Example Scripts with Results:

With ImportDuplicate parameter

```
Load-JobXml -XmlFilePath C:\Users\Administrator\Desktop\MigrateToSPO.xml -  
ImportDuplicate  
6 job(s) successfully imported out of a total of 6 job(s), in 0m 0s
```

Without ImportDuplicate parameter

```
Load-JobXml -XmlFilePath C:\Users\Administrator\Desktop\MigrateToSPO.xml  
4 job(s) successfully imported out of a total of 6 job(s), in 0m 0s
```

Refreshing the Jobs List

NOTE: The refresh is applied to whichever job list Content Matrix is currently connected to.

To refresh the Job List:

1. From the **Manage Queue** dialog, select a job in the Job List. The row selector icon and the highlighted row indicates the selected row.
2. From the Job List menu bar, choose **File > Refresh**.

If the status of the job has changed, the Status value will indicate the new status of the job.

Creating and Running a PowerShell Script from the Jobs List

In order to create a PowerShell (PS) script for Content Matrix, a job list (or batch file) must first exist in the [Job List](#) section of the Content Matrix Console. Once created, it can be [run from the PowerShell console](#) or scheduled to [run as a Windows Scheduled task](#).

NOTES:

- It is recommended that the connections to the source and target environments have the **Remember my password check-box** selected. This is to ensure that the PowerShell scripts will be able to establish a connection to both the source and target environments when they are being run. If a password is required and this check-box is not set, the migration will fail. However, users can manually enter this value into the PowerShell script itself if the option was not checked when the script was first generated.
- Web Browser Authentication, O365 Web Browser Authentication, and Forms-based Authentication are not supported for running a job using a PowerShell script.

Refer to the Quest Support Knowledge Base article [Connections that will work with PowerShell and Connections that doesn't work with PowerShell](#) for complete details.

To create a PowerShell script:

1. In Job List, and select the job (or jobs) that you want to run in PowerShell.
2. Click the **Generate PowerShell Script** button in the Job List tool bar, or right-click on one of the items and select Generate PowerShell Script from the context menu.
3. From the drop-down, choose the appropriate option. Use the information in the following table for guidance.

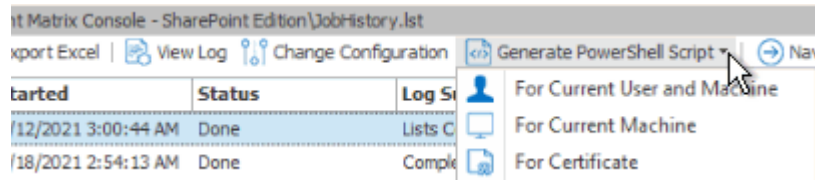

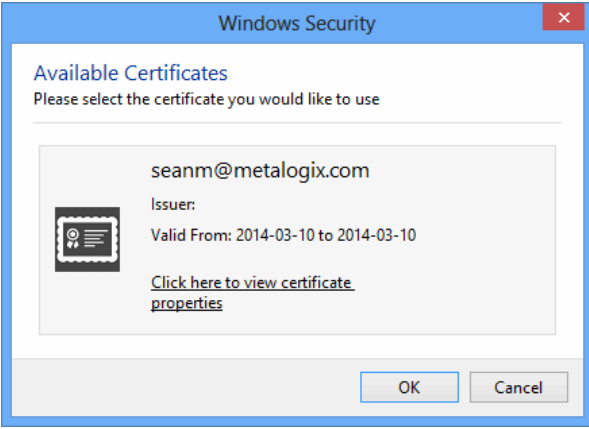
If you want to generate a PowerShell script for scheduling ...	Choose ...
that can be used only by the currently logged in User Account on the machine it is generated on	<p>For Current User and Machine.</p> <p>NOTE: Any PowerShell scripts that are generated for scheduling through this option can only be run by the logged in user on the machine they were generated on.</p>
that can be used by any User account on the machine it is generated on	<p>For Local Machine.</p>
that can be used by any User account on any machine that has the certificate that is specified when the script is created	<p>For Certificate.</p> <p>When you save the PowerShell script using this method you will be prompted to select a security certificate that exist on that machine. The selected certificate will be required on any system that attempts to run the script at a later date.</p> 

Once the PS script generation type is selected, Content Matrix Console will generate a PS script for the select Job, which will be written to a Microsoft Notepad file. If multiple jobs are selected they will all be written to the same file.

4. Choose **File > Save As...** and select any desired save location for the PowerShell script. Give the file any name you want, but change the **file type** to **.PS1**.

```

31b13266-2aa0-46e3-ac4d-6db2e7e0bb82.ps1 - Notepad
File Edit Format View Help
if ( (Get-PSSnapin -Name Metalogix.System.Commands -ErrorAction SilentlyContinue) -eq $null ) { add-pssnapin
Metalogix.System.Commands | out-null }
if ( (Get-PSSnapin -Name Metalogix.SharePoint.Migration.Commands -ErrorAction SilentlyContinue) -eq $null ) {
add-pssnapin Metalogix.SharePoint.Migration.Commands | out-null }

# Load configuration settings
Load-MetalogixConfigurationVariableSettings -FilePath "C:\ProgramData\Metalogix\EnvironmentSettings.xml" -Scope
EnvironmentSpecific
Load-MetalogixConfigurationVariableSettings -FilePath "C:\Users\seann\AppData\Roaming\Metalogix\Content Matrix
Console - SharePoint Edition\ApplicationSettings.xml" -Scope ApplicationAndUserSpecific
Load-MetalogixConfigurationVariableSettings -FilePath "C:\Users\seann\AppData\Roaming\Metalogix\UserSettings.xml"
-Scope UserSpecific

# Load source
$SourceCollection = New-MetalogixSerializableObjectCollection "<IXMLAbleList
IXMLAbleType="Metalogix.Explorer.NodeCollection, Metalogix.Explorer, Version=7.0.0.1, Culture=neutral,
PublicKeyToken=3b240fac3e39fc03"><NodeCollection><Location Path="/http:%2F%2Fmoss2007-es%2F/AndrewTest/Demo"
DisplayUrl="http://moss2007-es/AndrewTest/Demo"><Connection NodeType="Metalogix.SharePoint.SPServer,
Metalogix.SharePoint, Version=7.0.0.1, Culture=neutral, PublicKeyToken=3b240fac3e39fc03" ShowAllSites="True"
AdapterType="SP" Url="http://moss2007-es" ReadOnly="False"
AuthenticationType="Metalogix.SharePoint.Adapters.Authentication.WindowsInitializer"
/></Location></NodeCollection></IXMLAbleList">

# Load target
$TargetCollection = New-MetalogixSerializableObjectCollection "<IXMLAbleList
IXMLAbleType="Metalogix.Explorer.NodeCollection, Metalogix.Explorer, Version=7.0.0.1, Culture=neutral,
PublicKeyToken=3b240fac3e39fc03"><NodeCollection><Location Path="/TestingArea" DisplayUrl="http://sps2010-
sm/TestingArea"><Connection NodeType="Metalogix.SharePoint.SPWeb, Metalogix.SharePoint, Version=7.0.0.1,
Culture=neutral, PublicKeyToken=3b240fac3e39fc03" ShowAllSites="True" AdapterType="SP" Url="http://sps2010-
sm" ReadOnly="False" AuthenticationType="Metalogix.SharePoint.Adapters.Authentication.WindowsInitializer"
/></Location></NodeCollection></IXMLAbleList">

# Run the action
foreach($Target in $TargetCollection) {
    $SourceCollection | Copy-MLSharePointSite -Target $Target -CopyPermissionLevels -CopySitePermissions -
CopyAccessRequestSettings -CopyAssociatedGroups -CopySiteWebParts -CopyLists -OverwriteSites -
RecursivelyCopySubsites -CopyContentTypes -CopyNavigation -CopySiteFeatures -RunNavigationStructureCopy -
  
```

The PowerShell (PS) script itself contains five sections. They are:

- Section 1 - This first section at the top (starting with an "if" statement) runs a check in the PowerShell console to make sure that the Metalogix [snap-ins](#) have been added. If they are not found then it will add them to that instance of the PS console.
- Section 2 - **Load Configuration settings** - This section will find and load all of the Content Matrix client application configuration settings into the PowerShell script. These are the client application's environmental settings and not the migration/action settings.
- Section 3 - **Load source** - This section will load all of the data for the source environment connection.
- Section 4 - **Load target** - Similar to the previous section, this will load target environment's connection information.
- Section 5 - **Run the action** - Last is the "Run the action" section. This last section will contain all of the other data for the migration, such as the type of migration (i.e. a site migration, list migration, item migration, etc.) and all of the settings and configurations for the migration/action that is being run. This includes things like settings for versions, content types, permissions, etc.

Now you can [run](#) or [schedule](#) the PowerShell script.

Running a PowerShell Script

Once a PowerShell script has been [created](#), you can run it from the PowerShell console.

To run the PowerShell script:

NOTES:

- If you have more than one edition of Content Matrix, only one edition can be run per PowerShell session.
- If Content Matrix settings is changed, in order to apply new settings all PowerShell sessions must be restarted.

To add the PowerShell cmdlets for the application framework:

1. Open a Powershell ISE or PowerShell console session.
2. Run the Add-PSSnapin command and by pasting in the following text:

```
if ( $PsVersionTable.PSVersion.Major -lt 3 ) { Write-Host "Windows PowerShell Version 3.0 or later needs to be installed in order to run Content Matrix PowerShell scripts."; exit; }if ( (Get-PSSnapin -Name Metalogix.System.Commands -ErrorAction SilentlyContinue) -eq $null ) { add-pssnapin Metalogix.System.Commands | out-null }if ( (Get-PSSnapin -Name Metalogix.Exchange.Commands -ErrorAction SilentlyContinue) -eq $null ) { add-pssnapin Metalogix.Exchange.Commands | out-null }if ( (Get-PSSnapin -Name Metalogix.SharePoint.Commands -ErrorAction SilentlyContinue) -eq $null ) { add-pssnapin Metalogix.SharePoint.Commands | out-null }if (Get-Command Set-MetalogixJobPrerequisites -ErrorAction SilentlyContinue){ Set-MetalogixJobPrerequisites -Value "Content Matrix Console - Public Folder Edition" }
```

2. Set the directory to the location where the PowerShell script is located.
3. Enter the name and extension of the PowerShell Script (at its specified location), and the script will run.

In the case that you are running a script from the same directory you would use the format: `.[ScriptName].ps1`. So if your PowerShell scrip was named "ResourceScript.ps1" then you would enter: `.\ResourceScript.ps1` into the window, and the script would run.

If the script is in a different directory, you would enter the location of that directory relative to your current location, followed by the script name. For example, if your prompt is at the "C:\\" drive and your PowerShell script, named "ResourceScript.ps1" is on the desktop you would enter: `C:\Users\[User]\Desktop\ResourceScript.ps1`, and the script would run.

NOTE: In some cases the Execution Policy may prevent you from running a PowerShell script. In this case you will likely see the message: `[Script].ps1 cannot be loaded because the execution of scripts is disabled on this system.` Please see "get-help about_signing" for more details. In this case, running the

command: set-executionpolicy RemoteSigned should change the existing script policy to allow you to run these scripts for your location. It is advised that you check with your System Administrators before doing this to ensure that no Company Policies are being broken by this action. If this is an action you need to take, you should only need to run this command once.

The migration will begin, and any warnings and/or errors that are encountered in running the script will be displayed in the PowerShell window.

Scheduling a PowerShell Script to Run as a Windows Scheduled Task

Once a PowerShell script has been [created](#), you can run any migration job as a scheduled task on the system that the client application is installed on. This can be any migration action that exists in the Job List section, whether it's a migration job that was saved or a job that was previously run.

The **Generate PowerShell Script** option saves configurations for the selected job(s) as a PowerShell script. After the script has been saved, you must create a Windows Scheduled task directly in the Windows Task Scheduler.

Once these jobs have been created as scheduled tasks they can no longer be viewed (as scheduled tasks) in Content Matrix. If you want to make any other modifications or remove the task you can do so directly in the Windows Task Scheduler. If a task has been scheduled, the system will be able to run the task at the appointed time(s), regardless of whether Content Matrix client application is open.

To schedule a PowerShell script to run via the Windows Task Scheduler:

1. On the system where the scheduled task will run, open the Windows Task Scheduler.
2. Choose **Actions > Create Task**.
3. Enter a task **Name** and **Description**.
4. In the **General** tab, go to **Security** options and specify the user account that the task should be run under. Change the settings so the task will run regardless of whether the user is logged in.
5. Select the **Triggers** tab, and click **[New]** to add a new trigger for the scheduled task. This new task should use the **On a schedule** option. The start date can be set to a desired time, and the frequency and duration of the task can be set based on your specific needs. Click **[OK]** when your desired settings are entered.
6. Select the **Actions** tab and click **[New]** to set the action for this task to run. Set the Action to **Start a program**.
7. In the **Program/script** box enter "PowerShell."
8. In the **Add arguments (optional) box** enter the value ".\[Your PowerShell Script Name]." For example, if your PowerShell Script is named "Migration1.ps1" then you would enter ".\Migration1.ps1" as the value.
9. In the **Start in (optional)** box, add the location of the folder that contains your PowerShell script.

NOTE: The location used in the Start in box will also be used for storing the scheduled task run times, the job history for the copies, and any additional logging that may occur.

10. When all the desired settings are made, click **[OK]**.
11. Set any other desired settings in the Conditions and Settings tabs.
12. Once all the desired actions have been made (or added), click **[OK]**.

The task will be immediately set, and is ready to run.

After the scheduled task has run, a new entry will be added to Content Matrix's Job List section.

Triggering a Job in the Content Matrix Console to Run Using PowerShell

As an alternative to generating a PowerShell script, you can use PowerShell to trigger jobs that have been created in the Content Matrix Console.

To access the PowerShell cmdlets for triggering jobs to run:

Open a PowerShell or PowerShell ISE session and [add the PowerShell snap-ins for the application framework](#).

The following cmdlets for running jobs are now available:

- Get-MLJobs
- Invoke-MLJob

To retrieve information about jobs in the Console:

1. Select (from the PowerShell ISE Command Window) or enter **Get-MLJobs**.
2. (Optional) Enter one or more of the following parameters if you want to filter jobs:

- **JobNameOrTitle**
- [JobStatus](#)
- **Source**
- **Target**

NOTE: If you do not apply filters, all jobs in the Console will be retrieved.

3. Run the cmdlet.

Example scripts:

```
Get-MLJobs
```

```
Get-MLJobs -Source https://outlook.office.com/User mailbox/Drafts -Target https://metalogixsoftware.sharepoint.com/sites/HR/Ma -JobStatus Failed -JobNameOrTitle "Paste Exchange Folder"
```

To run one or more jobs:

1. Select (from the PowerShell ISE Command Window) or enter **Invoke-MLJob**.
2. Select or enter additional parameters. Use the information in the following table for guidance.

Parameter	Notes
JobID	<ul style="list-style-type: none"> • You can obtain the JobId by running the Get-MLJobs cmdlet. • You can run multiple jobs using the PowerShell Pipeline variable.
JobStatus	<p>Valid statuses are:</p> <ul style="list-style-type: none"> • Running • Not Running • Paused • Aborted • Aborting • Done • Warning • Failed • Queued • Triggered • Cancelling • Cancelled
Quiet	Use this parameter if you do not want to display a status of the job as it is running.
RunRemotely	<p>Use this parameter if you want to submit the job for Distributed Migration.</p> <p>NOTE: This option is valid for SharePoint Edition only.</p>

3. Run the cmdlet.

Example Scripts

```
Invoke-MLJob -JobId '92416012-4b69-4d4e-b3c2-984cde279909'
```

```
Invoke-MLJob -JobStatus Failed
```

Run multiple jobs using the PowerShell pipeline variable:

```
Invoke-MLJob -JobID 'c8176dd1-f1fd-484c-bc66-c002f5406f05' -RunRemotely  
'5ca0d97f-4d1d-445f-a6d9-3292abe89a6f', '0a2e0874-a759-46f4-b459-  
bb98ec2991ad' | Invoke-MLJob '30bf6d71-0a28-4012-b612-2d22562b5b46',  
'0b094765-46e0-4919-8922-cc5fe841e1f5' | Invoke-MLJob -Quiet
```

Job Log Files

You can view the progress of a migration tab in real-time via interactive log files. The logs are fully searchable.

To view an interactive log:

After starting an action, click **Details>>** in the progress dialog box.

NOTE: All logging in Content Matrix is done through jobs. If a job list is deleted from the [Job List](#), all logging for those actions will also be deleted. There is no backup for the job lists, unless the job is manually saved to another location. Once a job list is deleted, all logging for the actions within that job list are gone. Content Matrix will automatically hold any job lists created through any copy actions, in the Job Lists section, and these job lists can only be deleted through the appropriate Delete commands. The job lists can also be manually selected and saved through the Job list section.

There are two types of jobs in Content Matrix:

A **job list** is a collection of job items. A Job list is created for each copy or compare action that is made. Any "Copy" action/job that is in the Job List section can be used as the base of an incremental copy job. Job items can be viewed in the Log Viewer, by opening a job list. There are three basic ways to open a job list to access the Log Viewer:

- Double-click on a job list.
- Select a job list, then in the Job List section of the toolbar click **View Log**.
- Select a job, right-click, and choose **View log**.

Job items are job files, or logging, for individual items within the scope of an action. For example, if a SharePoint site is copied, there would be a job item for adding each list and each item in that list, and one job item for adding or creating each site or sub-site. If a SharePoint list with five documents is copied, then there would be a job item for adding/creating the list, and then one job item for adding each of the documents.

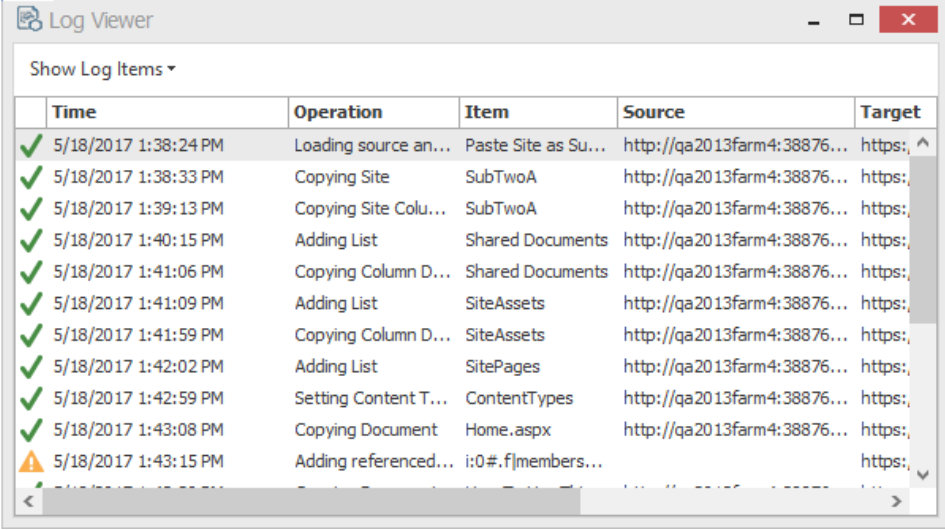

The screenshot shows a window titled "Log Viewer" with a table of log items. The table has columns for Time, Operation, Item, Source, and Target. The log items are as follows:

	Time	Operation	Item	Source	Target
✓	5/18/2017 1:38:24 PM	Loading source an...	Paste Site as Su...	http://qa2013farm4:38876...	https: ^
✓	5/18/2017 1:38:33 PM	Copying Site	SubTwoA	http://qa2013farm4:38876...	https:
✓	5/18/2017 1:39:13 PM	Copying Site Colu...	SubTwoA	http://qa2013farm4:38876...	https:
✓	5/18/2017 1:40:15 PM	Adding List	Shared Documents	http://qa2013farm4:38876...	https:
✓	5/18/2017 1:41:06 PM	Copying Column D...	Shared Documents	http://qa2013farm4:38876...	https:
✓	5/18/2017 1:41:09 PM	Adding List	SiteAssets	http://qa2013farm4:38876...	https:
✓	5/18/2017 1:41:59 PM	Copying Column D...	SiteAssets	http://qa2013farm4:38876...	https:
✓	5/18/2017 1:42:02 PM	Adding List	SitePages	http://qa2013farm4:38876...	https:
✓	5/18/2017 1:42:59 PM	Setting Content T...	ContentTypes	http://qa2013farm4:38876...	https:
✓	5/18/2017 1:43:08 PM	Copying Document	Home.aspx	http://qa2013farm4:38876...	https:
⚠	5/18/2017 1:43:15 PM	Adding referenced...	i:0#.f members...		https: v

Job items are job files, or logging, for individual items within the scope of an action. For example, if a SharePoint site is copied, there would be a job item for adding each list and each item in that list, and one job item for adding or creating each site or sub-site. If a SharePoint list with file documents is copied, then there would be a job item for adding/creating the list, and then one job item for adding each of the documents.

From the Log Viewer you can select and view any job items that exists within that job list.

NOTE: Some actions in Content Matrix have the ability to run with **Verbose Logging**. This option will increase the size of the log file.

Log Item Details

To view Log Item Details:

1. From the Log Viewer, select the item whose details you want to view.
2. Use one of the following options:
 - Double-click on the item.
OR
 - Right-click and choose **View Job Item**.
OR
 - If the job is currently running, click **Details>>**.

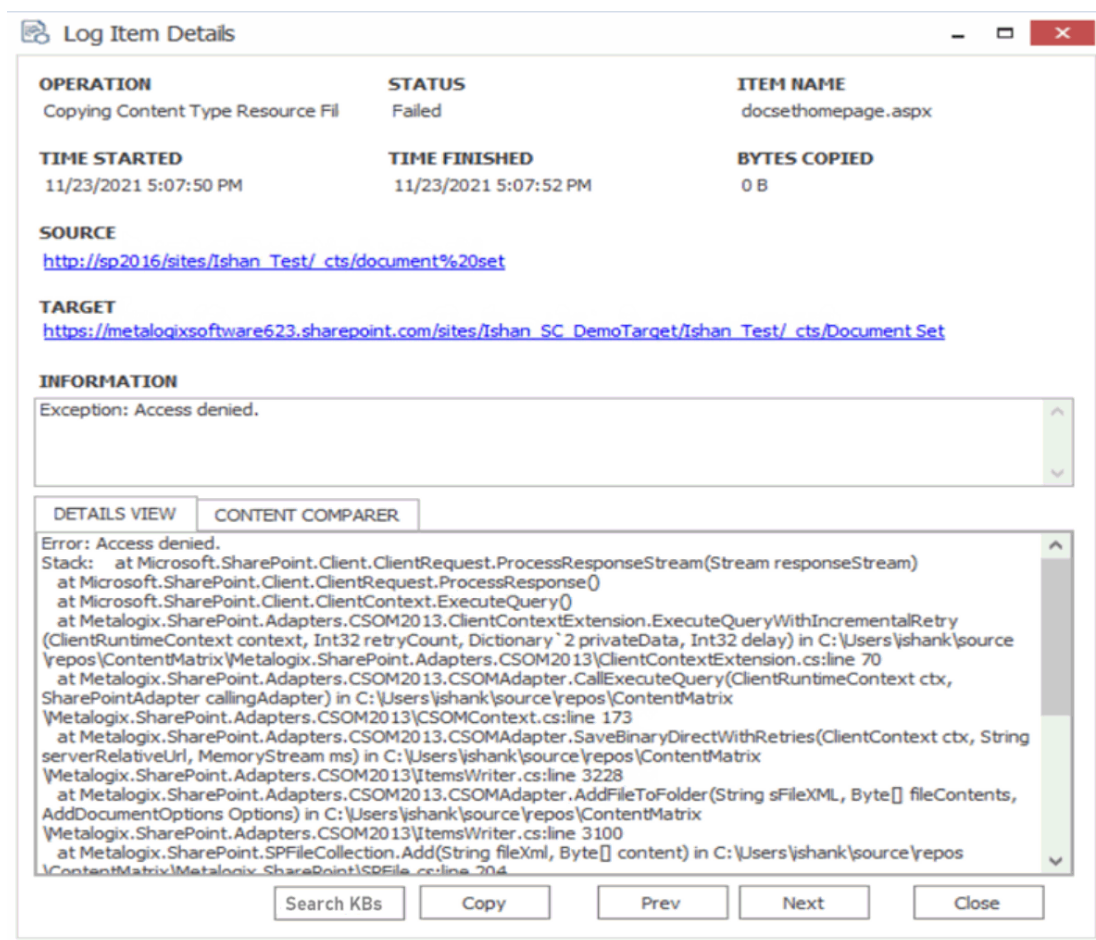

The Job Details dialog contains the following information:

- **Operation** - The last operation performed on the item.
- **Status** – The status of the item.
- **Item Name** - For items, the Item ID. For documents, the Filename.
- **Time Started** – The time the action for the item was started.
- **Time Finished** – The time the action for the item was finished.
- **Bytes Copied** – The bytes (B) that were copied in the action. This will be displayed in KB in some cases.
- **Source** - The Source URL for the item.
- **Target** - Target URL for the item.
- **Information** - Provides an informational message about the item, such as. This section will provide a description for any different and/or missing attributes/metadata for an item.
- **Details View** - Any errors that were encountered with the item when an action was performed.
- **Content Comparer tab** - Any differences between Source and Target content (from a compare action). You can display this information in either a **Grid View**, which displays a metadata property grid for the item, or as a **Text View**, which displays a XML text format of the item. This option is most useful if **Verbose Logging** has been checked

You can also:

- Use **[Search KBs]** to have Content Matrix query the [Quest Support Knowledge Base](#) for relevant articles if you selected a failed item.
- Use **[Copy]** to copy all of the item information and details (including the Details tab) into the system's clipboard. You can then paste the information when it can then be pasted to another location. When pasted the information will look similar to that of the actual Log Item Details dialog. This can be used for easy copy/pasting of an items migration log details.
- Use **[Prev]** and **[Next]** buttons to move to the previous or next item on the list (if applicable).

Exporting Jobs to an Excel File

You can export a selected job or multiple jobs from the Job List section into a Microsoft Excel file. The export will include all of the operations within each job (whether it is a migration action or some other action), and their details. This is to help users better understand their migration data and results, and provides another way to review the resulting logs.

In addition to the log details that are provided, there are also a number of tables and charts that can be accessed in different tabs within the Excel file. These tables and charts will help breakdown the information in a more visible manner.

To export one or more jobs to an Excel file:

1. In the [Job List](#), select the job(s) you want to export.
2. Use one of the following options:
 - From the Job List menu, select **Export Excel**
 - OR
 - Right-click and choose **Export selected job to Excel**.
3. Save the file to the desired location.

By default the Excel file will open after it has been created. This process may take a few minutes depending on the size of the selected job(s) and the number of actions in the log(s).

Information in Exported Excel Files

When an Excel file is exported from the Content Matrix Job List there are a number of page tabs that can be viewed. Each page tab will display a different set of data, and some of these tabs will also display pivot graphs (with pivot tables behind them).

NOTE: The data within all of these Excel tabs (both the tables and the graphs) should only be considered a starting point when looking at your migration data. You can modify the existing graphs through various methods, such as applying filters, changing the data values, etc. You can also take the "raw" data from the LogItems tab and use it to create your own graphs or sets of data as required.

The exported file contains the following tabs:

- Jobs - All of the specific jobs that are included in the export. This includes migration jobs as well as other actions.
- LogItems - All of the operations that have been run by Content Matrix and provide all of the logging details that are available in the Log Viewer and Log Item Details windows. Some examples of these operations are: adding lists, adding content types, copying documents, adding users, updating lists, etc.

JobID	LogItemID	TimeStamp	Month	Day	Hour	Minute	FinishedTime	Duration	Sta
3e0f305-9f20-4048-e104-999d7758010f	77797194-17ac-4000-0445-200f09205a46	2014-03-05 13:10:59	3	5	13	30	2014-03-05 13:11:04	0:00:05	Cor
3e0f305-9f20-4048-e104-999d7758010f	07b08714-795d-494e-9990-c219659997fe	2014-03-05 13:11:07	3	5	13	31	2014-03-05 13:11:07	0:00:01	Cor
3e0f305-9f20-4048-e104-999d7758010f	b1f295ca-519b-4110-952a-851b6973be90	2014-03-05 13:11:06	3	5	13	31	2014-03-05 13:11:09	0:00:03	Cor
3e0f305-9f20-4048-e104-999d7758010f	#A03d7a-3baa-4af0-a177-64a37eca070b	2014-03-05 13:11:09	3	5	13	31	2014-03-05 13:11:17	0:00:08	Cor
3e0f305-9f20-4048-e104-999d7758010f	73027081-5241-43b9-9050-eada06566476	2014-03-05 13:11:09	3	5	13	31	2014-03-05 13:11:24	0:00:15	Cor
3e0f305-9f20-4048-e104-999d7758010f	b306818b-2962-42cf-8d7e-ebc9ea46241f	2014-03-05 13:11:13	3	5	13	31	2014-03-05 13:11:23	0:00:10	Cor
3e0f305-9f20-4048-e104-999d7758010f	a3c9b256-4701-4d85-bf55-3a037ae87404	2014-03-05 13:11:17	3	5	13	31	2014-03-05 13:11:18	0:00:01	Cor
3e0f305-9f20-4048-e104-999d7758010f	1e254217-7504-4891-a1e4-84c98a51687	2014-03-05 13:11:18	3	5	13	31	2014-03-05 13:11:18	0:00:00	Cor
3e0f305-9f20-4048-e104-999d7758010f	7a289069-318f-402a-e37d-a17073a14427	2014-03-05 13:11:20	3	5	13	31	2014-03-05 13:11:24	0:00:04	Cor
3e0f305-9f20-4048-e104-999d7758010f	a2982c93-027d-4967-923c-8c3a98815ac	2014-03-05 13:11:23	3	5	13	31	2014-03-05 13:11:23	0:00:00	Cor
3e0f305-9f20-4048-e104-999d7758010f	311db975-5665-4a51-ae55-1a985854361	2014-03-05 13:11:23	3	5	13	31	2014-03-05 13:11:24	0:00:01	Cor
3e0f305-9f20-4048-e104-999d7758010f	9bd7886b-340a-452e-9a5e-a85a9f1eaabb	2014-03-05 13:11:24	3	5	13	31	2014-03-05 13:11:24	0:00:00	Cor
3e0f305-9f20-4048-e104-999d7758010f	a51471f1-eb7e-437f-939e-6f3f8e2aa5	2014-03-05 13:11:26	3	5	13	31	2014-03-05 13:11:26	0:00:00	Cor
3e0f305-9f20-4048-e104-999d7758010f	ab4d2a9f-7c88-4485-9657-d00a75744245	2014-03-05 13:11:26	3	5	13	31	2014-03-05 13:11:29	0:00:03	Cor
3e0f305-9f20-4048-e104-999d7758010f	ec1c9381-57cc-4890-a0b8-c0ba729949e5	2014-03-05 13:11:27	3	5	13	31	2014-03-05 13:11:27	0:00:00	Cor
3e0f305-9f20-4048-e104-999d7758010f	5e10ca15-be7d-47c7-26af-3eb0e2248601	2014-03-05 13:11:27	3	5	13	31	2014-03-05 13:11:32	0:00:05	Cor
3e0f305-9f20-4048-e104-999d7758010f	6995e344-402a-4443-9603-7ad74306a300	2014-03-05 13:11:29	3	5	13	31	2014-03-05 13:11:32	0:00:03	Cor
3e0f305-9f20-4048-e104-999d7758010f	c20f5e60-5e91-4e8c-944e-7846000e29f	2014-03-05 13:11:31	3	5	13	31	2014-03-05 13:11:33	0:00:02	Cor
3e0f305-9f20-4048-e104-999d7758010f	5964a890-2781-498f-8e87-a371a901ea22	2014-03-05 13:11:33	3	5	13	31	2014-03-05 13:11:35	0:00:02	Cor
3e0f305-9f20-4048-e104-999d7758010f	09aeb050-49a5-450a-b275-20b1aa8ea2af	2014-03-05 13:11:35	3	5	13	31	2014-03-05 13:11:35	0:00:00	Skp
3e0f305-9f20-4048-e104-999d7758010f	09c235c4-a43f-4550-ac45-25a20ba35286	2014-03-05 13:11:38	3	5	13	31	2014-03-05 13:11:38	0:00:00	Skp
3e0f305-9f20-4048-e104-999d7758010f	9a697c01-ba2f-4a43-b228-e694aa6ff40	2014-03-05 13:11:34	3	5	13	31	2014-03-05 13:11:36	0:00:02	Cor
3e0f305-9f20-4048-e104-999d7758010f	b49a80fa-1e64-45cc-8d3c-81804b4868f	2014-03-05 13:11:34	3	5	13	31	2014-03-05 13:11:34	0:00:00	Skp
3e0f305-9f20-4048-e104-999d7758010f	a599311-2a2b-4405-a23b-490bc348909e	2014-03-05 13:11:35	3	5	13	31	2014-03-05 13:11:35	0:00:00	Cor
3e0f305-9f20-4048-e104-999d7758010f	267257a1-a843-4627-9547-67c11139a5	2014-03-05 13:11:35	3	5	13	31	2014-03-05 13:11:36	0:00:01	Cor
3e0f305-9f20-4048-e104-999d7758010f	9697a5fa-35a-4a83-a522-c405303c64af	2014-03-05 13:11:37	3	5	13	31	2014-03-05 13:11:38	0:00:01	Cor
3e0f305-9f20-4048-e104-999d7758010f	ca242d8f-4b11-4823-a760-3c290026d2ba	2014-03-05 13:11:38	3	5	13	31	2014-03-05 13:11:41	0:00:03	Cor
3e0f305-9f20-4048-e104-999d7758010f	052494c5-efcc-4142-9a08-6879123914f	2014-03-05 13:11:38	3	5	13	31	2014-03-05 13:11:41	0:00:03	Cor
3e0f305-9f20-4048-e104-999d7758010f	a594d1a-1941-42ab-872b-09662028850e	2014-03-05 13:11:41	3	5	13	31	2014-03-05 13:11:42	0:00:01	Cor
3e0f305-9f20-4048-e104-999d7758010f	92c4e705-7000-4027-8c0a-d8a1e6340cab	2014-03-05 13:10:21	3	5	13	30	2014-03-05 13:10:23	0:00:02	Cor
3e0f305-9f20-4048-e104-999d7758010f	82b0562b-229a-480c-bf6e-0299b8820521	2014-03-05 13:10:23	3	5	13	30	2014-03-05 13:10:40	0:00:17	Cor

- Error Rates - A graph that represents the number of errors and warnings that Content Matrix encounters during a migration on a "per minute" basis. The vertical axis will list the number of errors/warnings that are encountered (at the specified time), and the horizontal axis lists the amount of time (displayed in a "per minute" value). The horizontal axis can also be changed to display in month, day, or hour time values as well. Below the graph is a table that provides a different view of the same error/warning breakdown.

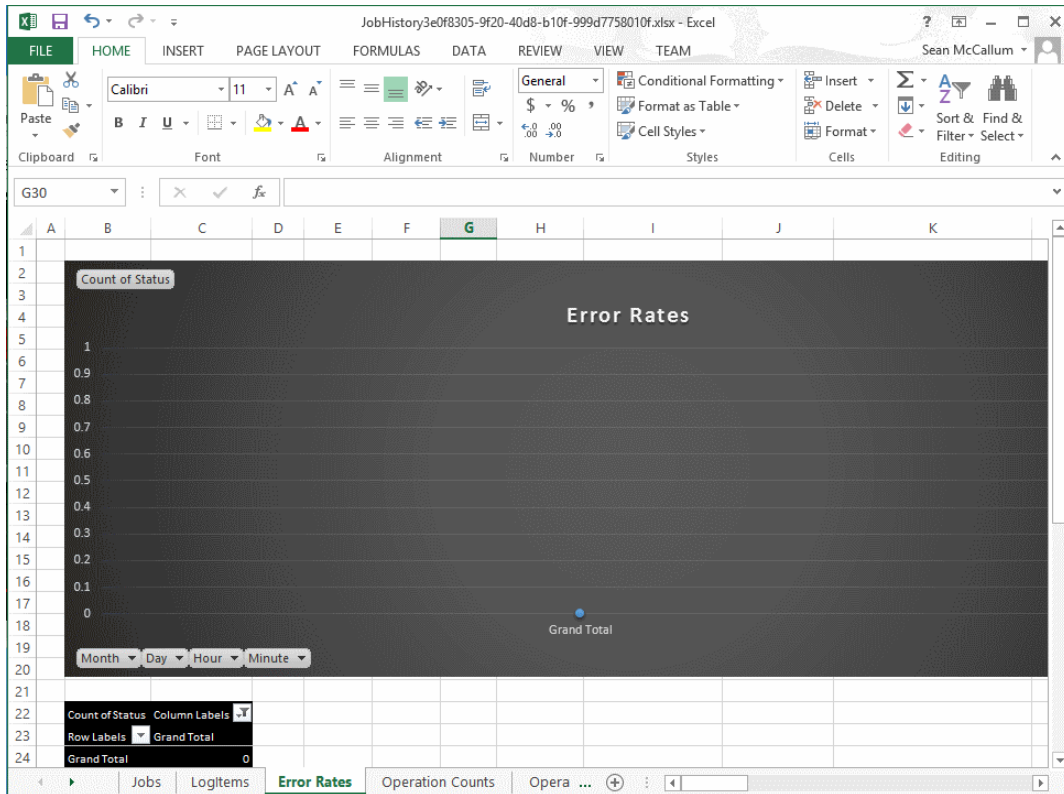

- Operation Counts - The number of operations/actions that are run over a period of time. Some examples are: copying sites, copying lists, copying documents, adding SharePoint groups, adding users, copying permissions, etc., and each operation has its own line representation on the graph. The vertical axis lists the number of operations that are running (at the specified time), and the horizontal axis lists the amount of time (this is displayed in a "per minute" value). The horizontal axis can also be changed to display in month, day, or hour time values as well. Below the graph there is a table that provides a different view of the same migration operation data.

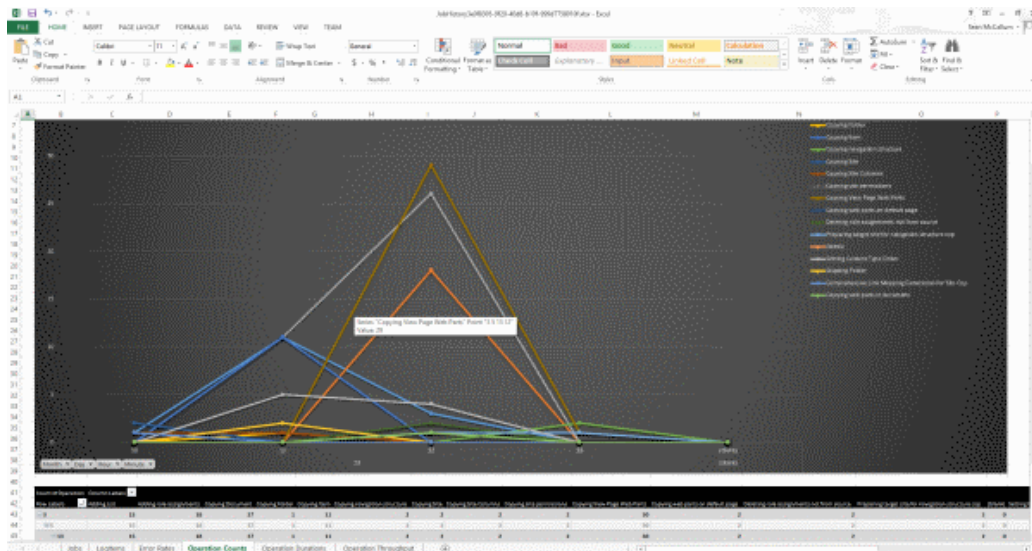

- Operation Duration - The total duration of time for each operation/action type against the total migration time. This is potentially the most confusing graph to read in the exported Excel file. The vertical axis lists the total duration time for each action. This is determined by finding the difference between each operation/actions Time Started and Time Finished values, and then

adding the totals together for all of that operation/actions of that type that are running. This is then displayed against the horizontal axis which lists the time (displayed in a "per minute" value) for the migration. The horizontal axis can also be changed to display in month, day, or hour time values as well. Below the graph there is a table that will provide a different view of the same migration data.

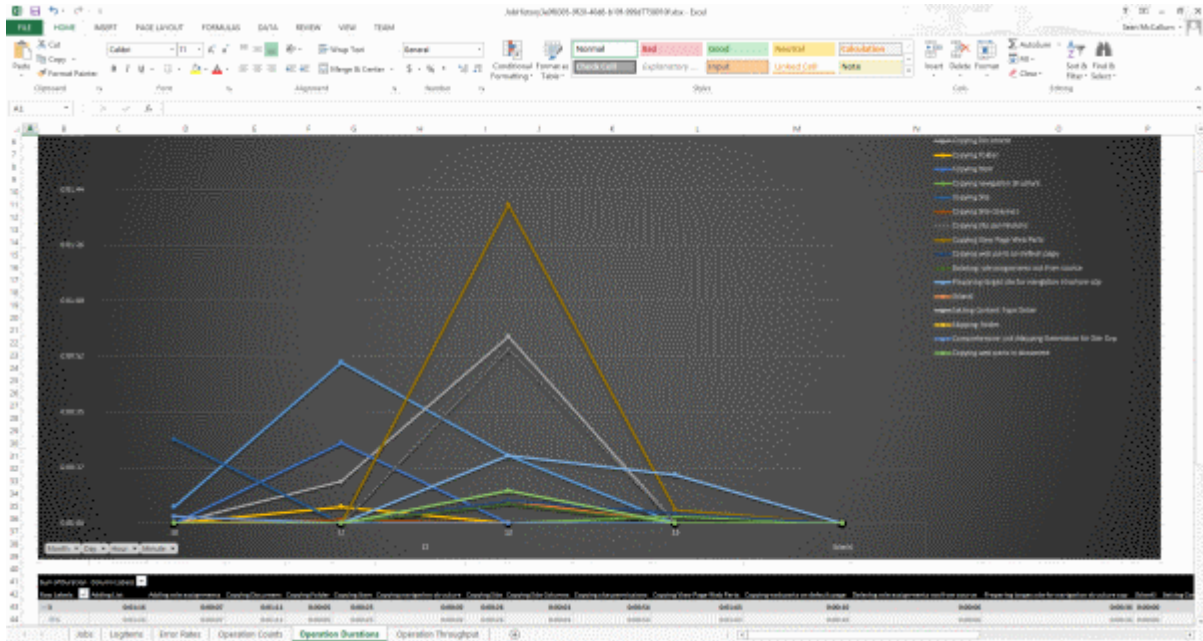

An example of how to read this graph is: if at minute 25 (of the hour, **not** the 25 minute of the migration) a large number of small documents are copied and completed (all in the 25th minute), then at minute 25 in the graph there will likely be a spike in the "duration time" for the "Copying Document" operation/action. If each document was copied in 2 seconds, and there were 41 small documents, then the **Sum of Duration** value would be listed as 82 seconds (or 0:01:22). So the results in the graph would show a spike for the **Copying Document** operation/action and minute 25, with a value of 0:01:22.

- Operation Throughput – The amount of data/throughput (in MB) that is migrated on a "per minute" basis. The vertical axis lists the amount of data that is being pushed through Content Matrix for a given operation (at the specified time), and the horizontal axis lists the time (displayed in a "per minute" value) at which that the action was performed. The horizontal axis can also be changed to display in month, day, or hour time values. Below the graph there is a table that will provide a different view of the same throughput data.

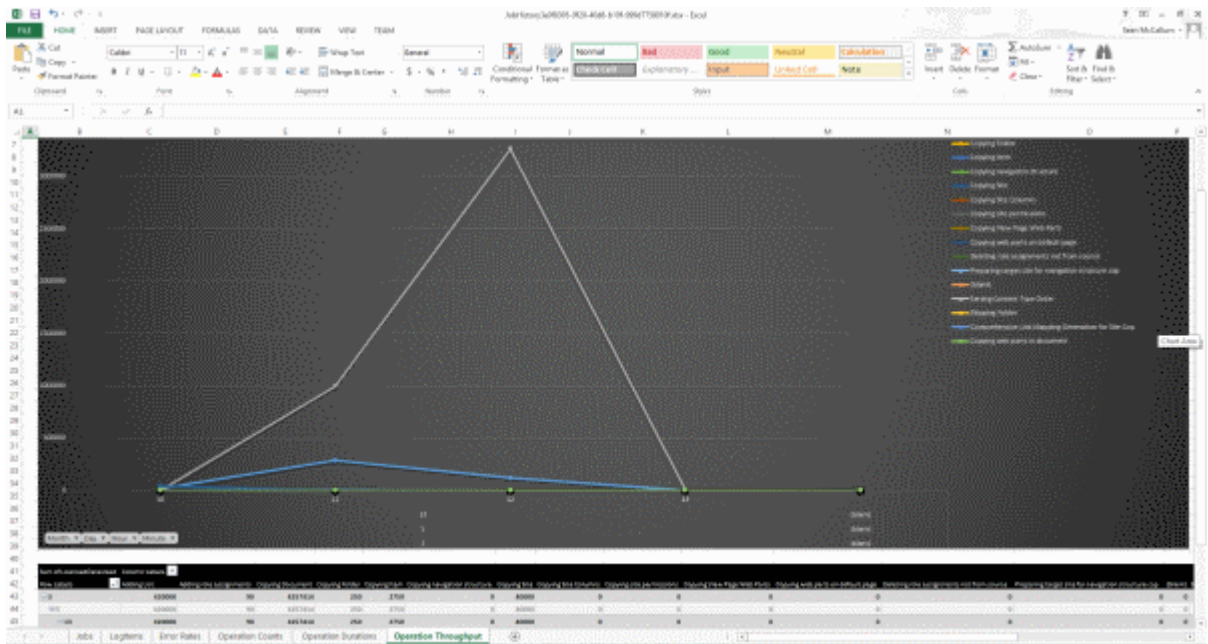

Copying Job Logging to Other Applications

It is possible to copy the results of migration jobs from log files to other applications. This can be beneficial if you want to keep track of copy or incremental information outside of Content Matrix, or want to manipulate the information for reporting or retention purposes. The log information is copied as text, to the clipboard, and can then be pasted within any other application that allows text pasting. For example, if a copy action was made, the logging can be copied into a Word file, or into an Excel spreadsheet, then saved.

NOTE: Only the end results of the total action will be copied.

To copy the logging for a job list:

1. Select a job from the **Job List**.
2. Right-click, and choose **Copy selected job to clipboard** (alternately Ctrl+C can be used).
3. Open the desired target program (for example: Microsoft Word, Microsoft Excel, Notepad, etc), then paste the content into the application (Ctrl+V, or the paste command in the application itself).

NOTE: The logging for each action within the list must be copied separately.

To copy the logging for job items:

- Select the desired job list or job item(s) that the logging is to be copied from, and open the job list to access the Log Viewer.
- Select any job items that are to be copied. Single or multiple items can be selected in the Log Viewer. In order to copy the logging for the entire job, all job items in the Log Viewer must be selected.

- When all of the desired items are selected, right-click on one of them, and select Copy Log Items to Clipboard, and select to either copy them with, or without details. The Details are a set of extra columns that are added to the logging. These columns are typically: **Details**, **SourceContent**, and **TargetContent**. These columns do not always contain extra information. The default copy option (Ctrl+C) is to copy the logging without the Details.

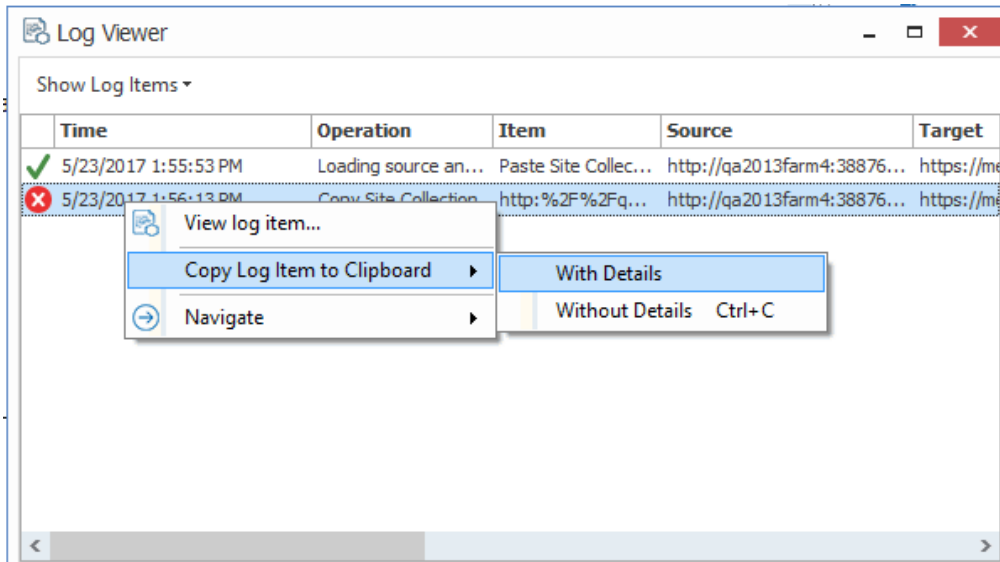

Creating a Support Zip File for a Migration Job

You can generate a zip file of data associated with a single migration job to help [Quest Support](#) facilitate troubleshooting.

The high-level data collected in the zip file includes:

- Application Settings files.
- Product information (product version, license, etc.).
- Information about the job (what action settings were set, the job log, etc.).

IMPORTANT: Sensitive Information

Please review the contents of the zip file before sending it to Support. While this feature attempts to only collect non-sensitive data, no guarantees can be made - it is up to you to ensure that any files in the zip folder are stripped of any confidential data. Regardless, Quest assures that the contents of the zip file will only be used for troubleshooting the associated support ticket. For added security, Content Matrix removes the encrypted password and token information from the file.

NOTE: Because passwords are removed, if you try to import a job from a Support zip file and there is no active connection to both the source and target, the import will fail. It is recommended that you create xml jobs using [Export to Xml](#) functionality instead of using the xml file generated by the Create

Support Zip File operation. Refer to the Knowledge Base article [While Importing a Job from a Support Zip File, the error “Could not load data: A password is required” is generated \(4369247\) \(quest.com\)](#) for details.

To create a Support zip file:

1. In the **Job List**, select the job for which the zip file is to be generated.
2. Use one of the following options:
 - In the main ribbon, click the **Help** tab, then **Create Support Zip File**.
 - Right-click and choose **Create Support Zip File**.
3. Save the file to the desired location using the desired file name.
4. If you wish to review the zip file for sensitive information, click **Yes** to open the zip file. Once you are satisfied with the contents of the zip file, it can be sent to [Quest Support](#) to aid in troubleshooting.

Enabling Trace Logging

You can enable trace logging on the machine where Content Matrix is installed and migrations are run to assist Quest Support with troubleshooting.

To enable trace logging:

1. Open the file **LogSettings.xml**, which can be found in one of the following folders:
 - If you are required to be a local administrator on the machine where Content Matrix is installed: C:\ProgramData\Metalogix

OR

 - If you are *not* required to be a local administrator on the machine where Content Matrix is installed: C:\Users\\AppData\Roaming\Metalogix\Common
2. Set `<LoggingLevel>` to one of the values described in the following table.

WARNING: When trace logging is enabled, entries are appended to the log file for each migration job that is run, and the same log file is used for all editions. This means the log file can become very large, which is why it is recommended that you only enable trace logging at the request of Quest Support.

Value	Description
None [Default]	Trace logging is disabled (i.e., no entries are written to the log file).
Error	Only Error messages are logged.

Value	Description
Debug	Error and Debug messages are logged. NOTE: Debug should only be used for advanced troubleshooting as it may impact migration performance.

Log entries are written to the file **MetalogixGlobalLog.txt**, which is located in the same folder as LogSettings.xml.

Using PowerShell with Content Matrix

Content Matrix can generate PowerShell scripts to be used to migrate SharePoint content through the PowerShell command window. You can also use PowerShell to perform other actions, including:

- [connecting to SharePoint](#)
- [triggering a job in the Content Matrix Console to run](#)

The Content Matrix PowerShell Console shortcut is added to the same Start Menu folder location where the Content Matrix Consoles are placed after installation. The same PowerShell console can be used for any edition, as long as the edition-specific [snap-ins](#) are used. You can also use a standard PowerShell console or PowerShell ISE.

Adding the PowerShell Snap-Ins for the Application Framework

Whenever a new PowerShell session is launched, the edition-specific snap-ins must be added before you can perform a Content Matrix action.

NOTES:

- If you have more than one edition of Content Matrix, only one edition can be run per PowerShell session.
- If Content Matrix settings change, in order to apply new settings all PowerShell sessions must be restarted.

To add the PowerShell cmdlets for the application framework:

1. Open a Powershell ISE or PowerShell console session.
2. Copy and paste the PowerShell snap-ins from the Quest Support Knowledge Base article located at <https://support.quest.com/content-matrix/kb/333879>.

Content Matrix PowerShell Commandlet List

Content Matrix can generate PowerShell script for you, for any migration action that is available through it. The below cmdlets are used in the generated PowerShell script, but can also be used to write your own script, should you desire to do so. For more information on each cmdlet, simply type **get-help [cmdlet]**. For example, if you want more information on **Copy-MLSharePointList** cmdlet you would enter **get-help Copy-MLSharePointList**, followed by the Enter (return) key.

Below is a list of the available cmdlets (and their parameters), broken up into the available commands for each snap-in.

Metalogix.System.Commands

Set-ApplicationDataPath

- **Path** - The path to be used as the root folder for the application path. Note that relative path elements relating to the product being used will still be generated within this directory, and that the application data will be contained within those folders. (Mandatory)
- **IncludeCompanyName** - Indicates that the Metalogix company name should still be used as part of the relative path from the specified directory to the application data folder.

Set-CommonDataPath

- **Path** - The path to be used as the root folder for the common data path. Note that relative path elements relating to the product being used will still be generated within this directory, and that the common data will be contained within those folders. (Mandatory)
- **IncludeCompanyName** - Indicates that the Metalogix company name should still be used as part of the relative path from the specified directory to the common data folder.

Get-MetalogixConfigurationVariable

- **Name** - The name of the configuration variable. (Mandatory)
- **ValueType** - Specify the value type of the configuration variable. This type must be IConvertible. (Default: IConvertible).

New-Filter

- **PropertyName** - The name of the parameter to compare the value to on the object being filtered. (Mandatory)
- **Operand** - The operand to use to compare the specified value to the given property value. (Mandatory)
- **Value** - The value to compare the given property to. (Mandatory)
- **CaseSensitive** - Indicates if the comparison should be case-sensitive. This parameter is only meaningful when the property to be compared to is a string.
- **TypeName** - The name of a type to apply the filter to. If not specified, the filter will apply to any object.

Join-Filter

- **Logic** - The logic to use in the join (and or or). (Mandatory)
- **FilterExpression** - The filter object to join together. Can be a set of filters). (Mandatory)

Invoke-Filter

- **Objects** (Mandatory)
- **Filter** (Mandatory)

Load-MetalogixConfigurationVariableSettings

- **FilePath** - The full file path of the configuration variable settings file to load. (Mandatory)
- **Scope** - The scope to load these settings into. (Default: Environment).

New-MetalogixSerializableObject

- **TypeName** - The name of the type of object to create. (Mandatory)
- **AssemblyName** - The name of the assembly containing the type to be created. (Mandatory)
- **SerializedValue** - The XML representation of a single serializable Metalogix object. (Mandatory)
- **Enumerate** - If set, any collections returned by the cmdlet will be enumerated. Otherwise, collections will be returned as a single object.

New-MetalogixSerializableObjectCollection

- **SerializedValue** - The XML representation of a Metalogix object collection. Generally this will be obtained by requesting the PowerShell command for a job configured in the GUI. This cmdlet is not recommended for general use. (Mandatory)

Set-MetalogixConfigurationVariable

- **Scope** - The scope of the configuration variable. Possible values are Environment, EnvironmentSpecific, User, UserSpecific, Application, ApplicationSpecific, ApplicationAndUserSpecific. (Default: ApplicationAndUserSpecific). (Mandatory)
- **Name** - The name of the configuration variable. (Mandatory)
- **Value** - The value of the configuration variable. (Mandatory)

Set-MetalogixDefaultResolverSetting

- **Name** - The name of the configuration variable ("ResourceTableResourceTableLink"). (Mandatory)
- **Value** - The value of the configuration variable. This value will indicate where to obtain configuration key settings from. Options are local file system ("Metalogix.ResourceFileTableResolver") or agent database (Metalogix.Core.ConfigVariables.ResourceDatabaseTableResolver). (Mandatory)

Metalogix.SharePoint.Commands

Add-MLSharePointSiteCollection

- **WebApplicationName** - Name of the Web Application to Create the Site Collection in. Web Application must exist in the specified Target. (Mandatory)
- **WebTemplateName** - Web (Site) Template to use for the Site Collection. Web (Site) Template must exist. The value must be in the form name#configuration. E.g., STS#1 for Blank Site (Mandatory)
- **Language** - Language to use for the Site Collection. Can be Language Code (LCID) or Language Name. Language must exist in the specified Target. (Mandatory)
- **Title** - The Title for the Site Collection. (Mandatory)
- **Description** - Description for the Site Collection.
- **Path** - Managed Path for the Site Collection. Include forward-slash characters where required. E.g., "/sites/" or "/sites/". (Mandatory)

- **URL** - Server Relative portion of URL solely used to identify the Site Collection itself. E.g., "TestSiteCollection" (Mandatory)
- **OwnerLogin** - Domain and username to be used as the Primary Administrator for the Site Collection. E.g., "sampledomain\sample.user" (Mandatory)
- **SecondaryOwnerLogin** - Domain and username to be used as the Secondary Administrator for the Site Collection. E.g., "sampledomain\another.user"
- **ContentDatabaseName** - Content Database Name to use. Not specifying this value will use the default content database (auto detect).
- **SelfServiceCreateMode** - Allow users without Farm Administrator privileges to add the Site Collection.
- **SetSiteQuota** - Set Quota for the Site Collection.
- **QuotaMaximum** - Limit site storage to maximum size (Mb). SetSiteQuota must be set to true and SelfServiceCreateMode should be false. Mutually exclusive with QuotaID.
- **QuotaWarning** - Send a warning email when the site storage reaches this size (Mb). SetSiteQuota must be set to true and SelfServiceCreateMode should be false. Mutually exclusive with QuotaID.
- **QuotaID** - Use Quota Template. Can be the integer ID or the string name of the Quota. SetSiteQuota must be set to true and SelfServiceCreateMode should be false.
- **Transformers** - The collection of data transformers which the action needs to run. Note that if the passed-in value for this parameter does not include transformers which are considered mandatory, they will be added automatically.
- **Quiet** - If set, the operation will not report progress to the PowerShell console.
- **JobFile** - The name of a job file to use for logging. If the file does not exist it will be created.
- **Source** - The source node for the actions.
- **Target** - The target node for the actions.
- **JobDatabase** - The connection string of a jobs database to use for logging. If the connection string is invalid, an exception is thrown. If both '**JobFile**' and '**JobDatabase**' parameters are specified, then the '**JobDatabase**' parameter will take precedence and the job will only be written to the job database.

Add-Permissions

- **Name** - The name of the user or group you wish to assign a permission level to. (Mandatory)
- **PermissionLevel** - The name of the permission level you want to grant the specified user or group. (Mandatory)

- **Recurse** - A flag that indicates the given permissions level should be granted to the given user for each item below the target which has unique permissions.
- **Transformers** - The collection of data transformers which the action needs to run. Note that if the passed-in value for this parameter does not include transformers which are considered mandatory, they will be added automatically.
- **Quiet** - If set, the operation will not report progress to the PowerShell console.
- **JobFile** - The name of a job file to use for logging. If the file does not exist it will be created.
- **Source** - The source node for the actions.
- **Target** - The target node for the actions.
- **JobDatabase** - The connection string of a jobs database to use for logging. If the connection string is invalid, an exception is thrown. If both '**JobFile**' and '**JobDatabase**' parameters are specified, then the '**JobDatabase**' parameter will take precedence and the job will only be written to the job database.

Add-SharePointFolder

- **Name** - The name of the folder to be created. (Mandatory)
- **Transformers** - The collection of data transformers which the action needs to run. Note that if the passed-in value for this parameter does not include transformers which are considered mandatory, they will be added automatically.
- **Quiet** - If set, the operation will not report progress to the PowerShell console.
- **JobFile** - The name of a job file to use for logging. If the file does not exist it will be created.
- **Source** - The source node for the actions.
- **Target** - The target node for the actions.
- **JobDatabase** - The connection string of a jobs database to use for logging. If the connection string is invalid, an exception is thrown. If both '**JobFile**' and '**JobDatabase**' parameters are specified, then the '**JobDatabase**' parameter will take precedence and the job will only be written to the job database.

Add-SharePointList

- **Name** - The name for the new list. (Mandatory)
- **TemplateName** - The numeric code of the template to use. (Mandatory)
- **Description** - A description of the list.

- **Title** - The title for the new list.
- **IsOnQuickLaunch** - Indicates if the list should be added to the quick launch.
- **HasVersions** - Indicates if the list should enable major versions.
- **HasMinorVersions** - Indicates if the list should enable minor versions.
- **RequiresContentApproval** - Indicates if the list should require content approval.
- **Transformers** - The collection of data transformers which the action needs to run. Note that if the passed-in value for this parameter does not include transformers which are considered mandatory, they will be added automatically.
- **Quiet** - If set, the operation will not report progress to the PowerShell console.
- **JobFile** - The name of a job file to use for logging. If the file does not exist it will be created.
- **Source** - The source node for the actions.
- **Target** - The target node for the actions.
- **JobDatabase** - The connection string of a jobs database to use for logging. If the connection string is invalid, an exception is thrown. If both '**JobFile**' and '**JobDatabase**' parameters are specified, then the '**JobDatabase**' parameter will take precedence and the job will only be written to the job database.

Add-SharePointSite

- **URL** - The URL name for the new site. If not specified, it will be automatically generated from the given name.
- **Name** - The name for the new site. (Mandatory)
- **TemplateName** - The name of the template to use, either in [Name]#[Config] form or by the name of the STP file. (Mandatory)
- **Transformers** - The collection of data transformers which the action needs to run. Note that if the passed-in value for this parameter does not include transformers which are considered mandatory, they will be added automatically.
- **Quiet** - If set, the operation will not report progress to the PowerShell console.
- **JobFile** - The name of a job file to use for logging. If the file does not exist it will be created.
- **Source** - The source node for the actions.
- **Target** - The target node for the actions.

- **JobDatabase** - The connection string of a jobs database to use for logging. If the connection string is invalid, an exception is thrown. If both '**JobFile**' and '**JobDatabase**' parameters are specified, then the '**JobDatabase**' parameter will take precedence and the job will only be written to the job database.

Clear-GlobalMappings

- **ClearGuidMappings** - Indicates that global GUID mappings should be cleared.
- **ClearURLMappings** - Indicates that global URL mappings should be cleared.
- **ClearUserMappings** - Indicates that global user mappings should be cleared.
- **ClearDomainMappings** - Indicates that global domain mappings should be cleared.

Compare-MLSharePointFolder

- **CompareFolders** - Indicates whether or not to compare folders.
- **CompareItems** - Indicates whether or not to compare items.
- **CompareVersions** - Indicates whether or not to compare item versions.
- **CompareMetadata** - Indicates whether or not to compare object metadata.
- **VerboseLog** - Indicates whether or not to compare object metadata.
- **HaltIfDifferent** - Indicates whether or not to halt the comparison if a difference is encountered.
- **FilterListsAndFolders** - Indicates whether or not to filter lists and folders.
- **ListAndFolderFilterExpression** - The filter expression applied to lists and folders.
- **FilterItemsAndVersions** - Indicates whether or not to filter list items and their versions.
- **ItemAndVersionFilterExpression** - The filter expression applied to list items and versions.
- **Transformers** - The collection of data transformers which the action needs to run. Note that if the passed-in value for this parameter does not include transformers which are considered mandatory, they will be added automatically.
- **Quiet** - If set, the operation will not report progress to the PowerShell console.
- **JobFile** - The name of a job file to use for logging. If the file does not exist it will be created.
- **Source** - The source node for the actions.
- **Target** - The target node for the actions.

- **JobDatabase** - The connection string of a jobs database to use for logging. If the connection string is invalid, an exception is thrown. If both 'JobFile' and 'JobDatabase' parameters are specified, then the 'JobDatabase' parameter will take precedence and the job will only be written to the job database.

Compare-MLSharePointList

This is the same as **Compare-MLSharePointFolder** with additional parameters.

Compare-MLSharePointSite

This is the same as **Compare-MLSharePointList** with additional parameters:

- **CompareLists** - Indicates whether or not to compare lists.
- **CompareSubSites** - Indicates whether or not to compare sub sites.
- **FilterSubSites** - Indicates whether or not to filter sub sites.
- **SubSiteFilterExpression** - The filter expression applied to sub sites.

Get-MLSharePointDatabase

- **Server** - The name of the database server. (Mandatory)
- **Database** - The name of the SharePoint content database. (Mandatory)
- **User** - A user to connect as, in DOMAIN\Login format.
- **Password** - The password for the user provided.

Get-MLSharePointFolder

This is the same as **Get-MLSharePointList** with an additional parameter:

- **FolderPath** - The list-relative path to the desired folder, seperated by "/". (Mandatory)

Get-MLSharePointFolderFromDatabase

This is the same as **Get-MLSharePointListFromDatabase** with an additional parameter:

- **FolderPath** - The list-relative path to the desired folder, separated by "/". (Mandatory)

Get-MLSharePointItembyFileName

- **FileName** - The filename of the SharePoint document. (Mandatory)
- **FolderPath** - The list-relative path to the desired folder, separated by "/"
- **ListName** - The name of the desired list. (Mandatory)
- **SiteURL** - The URL of the SharePoint site to connect to. (Mandatory)
- **User** - A user to connect as, in DOMAIN\Login format.
- **Password** - The password for the user provided.
- **AdapterType** - The short name of the adapter type you want to use for the connection. Use OM for a local SharePoint or WS for a remote SharePoint where the Metalogix Extensions Web Service is installed.
- **ReadOnly** - Indicates that the connection made to the SharePoint site should be read only.

Get-MLSharePointItembyID

- **Id** - The ID of the SharePoint item. (Mandatory)
- **FolderPath** - The list-relative path to the desired folder, separated by "/"
- **ListName** - The name of the desired list. (Mandatory)
- **SiteURL** - The URL of the SharePoint site to connect to. (Mandatory)
- **User** - A user to connect as, in DOMAIN\Login format.
- **Password** - The password for the user provided.
- **AdapterType** - The short name of the adapter type you want to use for the connection. Use OM for a local SharePoint or WS for a remote SharePoint where our Metalogix Extensions Web Service is installed.
- **ReadOnly** - Indicates that the connection made to the SharePoint site should be read only.

Get-MLSharePointItemFromDatabase

This is the same as **Get-MLSharePointListFromDatabase** with additional parameters:

- **FolderPath** - The list-relative path to the desired folder, separated by "/"
- **ItemName** - The filename or ID of the desired item. (Mandatory)

Get-MLSharePointList

This is the same as Get-MLSharePointSite with an additional parameter:

- **ListName** - The name of the desired list. (Mandatory)

Get-MLSharePointListFromDatabase

This is the same as **Get-MLSharePointSiteFromDatabase** with an additional parameter:

- **ListName** - The name of the desired list. (Mandatory)

Get-MLSharePointServer

- **ServerURL** - The URL of the SharePoint server to connect to. (Mandatory)
- **User** - A user to connect as, in DOMAIN\Login format.
- **Password** - The password for the user provided.
- **ReadOnly** - Indicates that the connection made to the SharePoint site should be read only.

Get-MLSharePointSite

- **SiteURL** - The URL of the SharePoint site to connect to. (Mandatory)
- **User** - A user to connect as, in DOMAIN\Login format.
- **Password** - The password for the user provided.
- **AdapterType** - The short name of the adapter type you want to use for the connection. Use OM for a local SharePoint or WS for a remote SharePoint where the Metalogix Extensions Web Service is installed.
- **ReadOnly** - Indicates that the connection made to the SharePoint site should be read only.

Get-MLSharePointTenant

- **TenantURL** - The URL of the SharePoint tenant to connect to. (Mandatory)
- **User** - A user to connect as, in user@company.onmicrosoft.com format. (Mandatory)
- **Password** - The password for the user provided. (Mandatory)
- **ReadOnly** - Indicates that the connection made to the SharePoint tenant should be read-only.

Get-SharePointSiteFromDatabase

- **Server** - The name of the database server. (Mandatory)
- **Database** - The name of the SharePoint content database. (Mandatory)
- **SiteURL** - The server-relative URL of the SharePoint site to connect to.
- **User** - A user to connect as, in DOMAIN\Login format.
- **Password** - The password for the user provided.
- **HostHeader** - A host header for a specified subsite. Use this if you are connecting to a site or subsite with a host header name.

Refresh-SharePointNode

- **Transformers** - The collection of data transformers which the action needs to run. Note that if the passed-in value for this parameter does not include transformers which are considered mandatory, they will be added automatically.
- **Quiet** - If set, the operation will not report progress to the PowerShell console.
- **JobFile** - The name of a job file to use for logging. If the file does not exist it will be created.
- **Source** - The source node for the actions.
- **Target** - The target node for the actions.
- **JobDatabase** - The connection string of a jobs database to use for logging. If the connection string is invalid, an exception is thrown. If both '**JobFile**' and '**JobDatabase**' parameters are specified, then the '**JobDatabase**' parameter will take precedence and the job will only be written to the job database.

Remove-MLSharePointFolder

- **Folder** - The Folder object retrieved by using the Get-MLSharePointFolder Cmdlet. (Mandatory)
-
- **Transformers** - The collection of data transformers which the action needs to run. Note that if the passed-in value for this parameter does not include transformers which are considered mandatory, they will be added automatically.
- **Quiet** - If set, the operation will not report progress to the PowerShell console.
- **JobFile** - The name of a job file to use for logging. If the file does not exist it will be created.
- **Source** - The source node for the actions.

- **Target** - The target node for the actions.
- **JobDatabase** - The connection string of a jobs database to use for logging. If the connection string is invalid, an exception is thrown. If both '**JobFile**' and '**JobDatabase**' parameters are specified, then the '**JobDatabase**' parameter will take precedence and the job will only be written to the job database.

Remove-MLSharePointItem

- **Item** - The ListItem object retrieved by using the Get-MLSharePointItem Cmdlet. (Mandatory)
- **Transformers** - The collection of data transformers which the action needs to run. Note that if the passed-in value for this parameter does not include transformers which are considered mandatory, they will be added automatically.
- **Quiet** - If set, the operation will not report progress to the PowerShell console.
- **JobFile** - The name of a job file to use for logging. If the file does not exist it will be created.
- **Source** - The source node for the actions.
- **Target** - The target node for the actions.
- **JobDatabase** - The connection string of a jobs database to use for logging. If the connection string is invalid, an exception is thrown. If both '**JobFile**' and '**JobDatabase**' parameters are specified, then the '**JobDatabase**' parameter will take precedence and the job will only be written to the job database.

Remove-MLSharePointList

- **List** - The list object retrieved by using the Get-MLSharePointList Cmdlet. (Mandatory)
- **Transformers** - The collection of data transformers which the action needs to run. Note that if the passed-in value for this parameter does not include transformers which are considered mandatory, they will be added automatically.
- **Quiet** - If set, the operation will not report progress to the PowerShell console.
- **JobFile** - The name of a job file to use for logging. If the file does not exist it will be created.
- **Source** - The source node for the actions.
- **Target** - The target node for the actions.
- **JobDatabase** - The connection string of a jobs database to use for logging. If the connection string is invalid, an exception is thrown. If both '**JobFile**' and '**JobDatabase**' parameters are specified, then the '**JobDatabase**' parameter will take precedence and the job will only be written to the job database.

Remove-MLSharePointSite

- **Site** - The site object retrieved by using the Get-MLSharePointSite Cmdlet. (Mandatory)
- **Transformers** - The collection of data transformers which the action needs to run. Note that if the passed-in value for this parameter does not include transformers which are considered mandatory, they will be added automatically.
- **Quiet** - If set, the operation will not report progress to the PowerShell console.
- **JobFile** - The name of a job file to use for logging. If the file does not exist it will be created.
- **Source** - The source node for the actions.
- **Target** - The target node for the actions.
- **JobDatabase** - The connection string of a jobs database to use for logging. If the connection string is invalid, an exception is thrown. If both '**JobFile**' and '**JobDatabase**' parameters are specified, then the '**JobDatabase**' parameter will take precedence and the job will only be written to the job database.

Remove-MLSharePointSiteCollection

- **SiteCollection** - The Site Collection object retrieved by using the Get-MLSharePointSite Cmdlet. (Mandatory)
- **Server** - The parent Server object of the Site Collection, retrieve by using the Get-MLSharePointServer Cmdlet. (Mandatory)
- **Transformers** - The collection of data transformers which the action needs to run. Note that if the passed-in value for this parameter does not include transformers which are considered mandatory, they will be added automatically.
- **Quiet** - If set, the operation will not report progress to the PowerShell console.
- **JobFile** - The name of a job file to use for logging. If the file does not exist it will be created.
- **Source** - The source node for the actions.
- **Target** - The target node for the actions.
- **JobDatabase** - The connection string of a jobs database to use for logging. If the connection string is invalid, an exception is thrown. If both '**JobFile**' and '**JobDatabase**' parameters are specified, then the '**JobDatabase**' parameter will take precedence and the job will only be written to the job database.

Search-SharePointSite

- **SearchTerm** - The search term to use.
- **MaxResults** - The number of search results to output.
- **MatchExactly** - Indicates that the search term must match one of the searched fields exactly.
- **Recursive** - Indicates that data within all subwebs should be included in the search.
- **Includeltems** - Indicates that the search results should include items.
- **IncludeDocuments** - Indicates that the search results should include documents.
- **IncludeFolders** - Indicates that the search results should include folders.
- **IncludeLists** - Indicates that the search results should include lists.
- **IncludeSites** - Indicates that the search results should include sites.
- **ContentType** - If specified, search results must include this value in their content type name.
- **Author** - If specified, search results must have been created by an author matching this value.
- **Editor** - If specified, search results must have been modified by an editor matching this value.
- **CreatedBefore** - If specified, search results must have been created before this date.
- **CreatedAfter** - If specified, search results must have been created after this date.
- **ModifiedBefore** - If specified, search results must have been modified before this date.
- **ModifiedAfter** - If specified, search results must have been modified after this date.
- **Transformers** - The collection of data transformers which the action needs to run. Note that if the passed-in value for this parameter does not include transformers which are considered mandatory, they will be added automatically.
- **Quiet** - If set, the operation will not report progress to the PowerShell console.
- **JobFile** - The name of a job file to use for logging. If the file does not exist it will be created.
- **Source** - The source node for the actions.
- **Target** - The target node for the actions.
- **JobDatabase** - The connection string of a jobs database to use for logging. If the connection string is invalid, an exception is thrown. If both 'JobFile' and 'JobDatabase' parameters are specified, then the 'JobDatabase' parameter will take precedence and the job will only be written to the job database.

Update-SharePointSiteCollectionSettings

- **SiteCollectionAdmins** - A list of login names to be granted site collection administrator privileges.
- **QuotaMaximum** - An independently defined maximum storage size for this site collection.

- **QuotaWarning** - An independently defined size at which to send a warning email for this site collection.
- **QuotaID** - A quota template ID to use for this site collection.
- **Transformers** - The collection of data transformers which the action needs to run. Note that if the passed-in value for this parameter does not include transformers which are considered mandatory, they will be added automatically.
- **Quiet** - If set, the operation will not report progress to the PowerShell console.
- **JobFile** - The name of a job file to use for logging. If the file does not exist it will be created.
- **Source** - The source node for the actions.
- **Target** - The target node for the actions.
- **JobDatabase** - The connection string of a jobs database to use for logging. If the connection string is invalid, an exception is thrown. If both '**JobFile**' and '**JobDatabase**' parameters are specified, then the '**JobDatabase**' parameter will take precedence and the job will only be written to the job database.

Metalogix.Jobs.Reporting.Commands

Export-JobHistory

- **SqlCeDbFilePath** - Specify the path to the SQL database file that contains the Job History data. (Mandatory)
- **ServerName** - The name of the SQL Server. (Mandatory)
- **DatabaseName** - The name of the Job History database. (Mandatory)
- **AuthType** - Indicates whether to use Integrated (Windows) or SQL Authentication. If not specified will Integrated Authentication will be used.
- **Username** - Specify the username for SQL Authentication.
- **Password** - Specify the password for SQL Authentication.

Metalogix.Exchange.Commands

Copy-ExchangeItem

- **UserMapper** - Defines the user mapping between Exchange and SharePoint users.
- **KeepAllDayEvent** - Indicates how all day events should be copied between different time zones. If this switch is on all day events will start in the same local time (hours:minutes) in target as were defined in source. Time zone difference is not calculated.
- **OutputType** - Defines the format in which Exchange items will be migrated to SharePoint. Possible options are: msg, eml.
- **SelectedFields** - Defines fields which will be migrated from Exchange item to SharePoint item.
- **ContainerSplitLimit** - Defines the limit for item count in SharePoint lists. If the item count in source Exchange folder reaches this limit, items will be placed in separate folders, which will be created on the fly. These folders will contain no more items than the defined limit.
- **VerboseLogging** - Indicates if the more detailed logging should be enabled.
- **Overwrite** - Indicates if the copy operation should overwrite existing items and documents.
- **Filters** - Defines a filter expression used to determine if a document or item should be copied.
- **ContentTypeOptions** - Defines a set of content type application rules for the item copying operation.
- **Transformers** - The collection of data transformers which the action needs to run. Note that if the passed-in value for this parameter does not include transformers which are considered mandatory, they will be added automatically.
- **Quiet** - If set, the operation will not report progress to the PowerShell console.
- **JobFile** - The name of a job file to use for logging. If the file does not exist it will be created.
- **Source** - The source node for the actions.
- **Target** - The target node for the actions.
- **JobDatabase** - The connection string of a jobs database to use for logging. If the connection string is invalid, an exception is thrown. If both '**JobFile**' and '**JobDatabase**' parameters are specified, then the '**JobDatabase**' parameter will take precedence and the job will only be written to the job database.

Copy-AllExchangeFolderItem

This is the same as **Copy-ExchangeItem** with additional parameters.

Copy-ExchangeFolder

This is the same as **Copy-ExchangeItem** with additional parameters:

- **PermissionMapper** - Defines the mapping between Exchange and SharePoint permissions.
- **SkipNonMappedPermissions** - Indicates if the non mapped users should be skipped.
- **ShowSubSite** - Indicates if the site created for migration should be displayed in the navigation line.
- **CopyPermissions** - Indicates if the permissions should be copied.
- **CreateSite** - Indicates whether a new site should be created for the migration.
- **SiteName** - Defines the name of the site which will be created for the migration. All data will be migrated to this site.
- **WebTemplateID** - Defines the web template id.
- **WebTemplateConfig** - Defines the web template configuration.
- **WebTemplateName** - Defines the web template which will be applied to SharePoint sites during the migration.
- **IsSiteHierarchy** - Indicates if the folder hierarchy should be created using sites.
- **EnableTreeViewOnSite** - Indicates if the tree view navigation should be enabled and shown in the SharePoint environment easing navigation.

Copy-ExchangeFolderToList

This is the same as **Copy-ExchangeFolder** with additional parameters.

Modifying Content Matrix Configuration and Settings

You can configure and customize a number of Content Matrix settings, including:

- [the use of encrypted SQL database connections](#)
- [proxy settings](#)
- [available actions and events](#)
- [default settings in configuration variable files](#)
- [client-side settings](#)
- [resource utilization settings](#)

Using Encrypted SQL Database Connections

When connecting to a [full SQL Content Matrix Job Database](#), you are given the option to connect using TLS/SSL encryption.

NOTE: Content Matrix can use any version of TLS that is compatible with .NET Framework 4.8. The default version of TLS used by the operating system on the machine from which you are connecting will be used by Content Matrix.

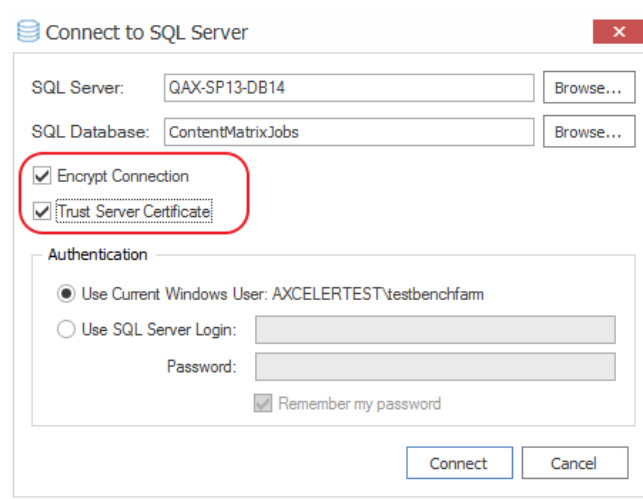

The encrypted connection can use either:

- a self-signed certificate or a trusted certificate from the third party authority (refer to the Microsoft article <https://docs.microsoft.com/en-us/sql/database-engine/configure-windows/enable->

[encrypted-connections-to-the-database-engine?view=sql-server-ver15](#) for instructions on configuring an encrypted connection using a certificate)

OR

- a SQL-generated certificate, which does not require configuration.

NOTE: If a trusted certificate is used, it is not necessary to check the **Trust Server Certificate** box. However, if the box is not checked and the certificate is not trusted, the following message will display:

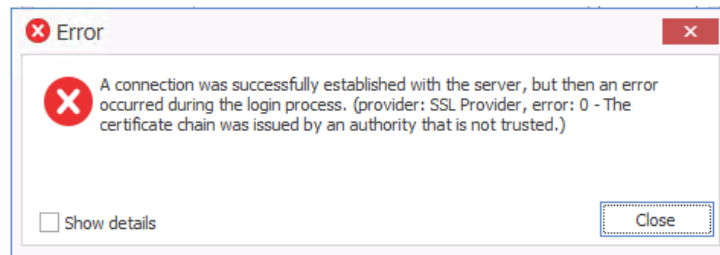

In this case, the **Trust Server Certificate** box must be checked in order to continue the connection.

Configuring Proxy Settings

In most cases Content Matrix can automatically connect to SharePoint and authenticate license keys, through an environment's proxy setting. However, in some cases the proxy may need to be configured within Content Matrix. In these cases users can specify the proxy settings through the connecting dialog.

There are two basic places where this proxy setting can be configured. The first of these is when [activating a license key](#), and the second when [connecting to SharePoint](#). The dialogs for these options look slightly different, and the when you are using a proxy to connect to SharePoint, you have the additional option to **Import Proxy from Internet Explorer**.

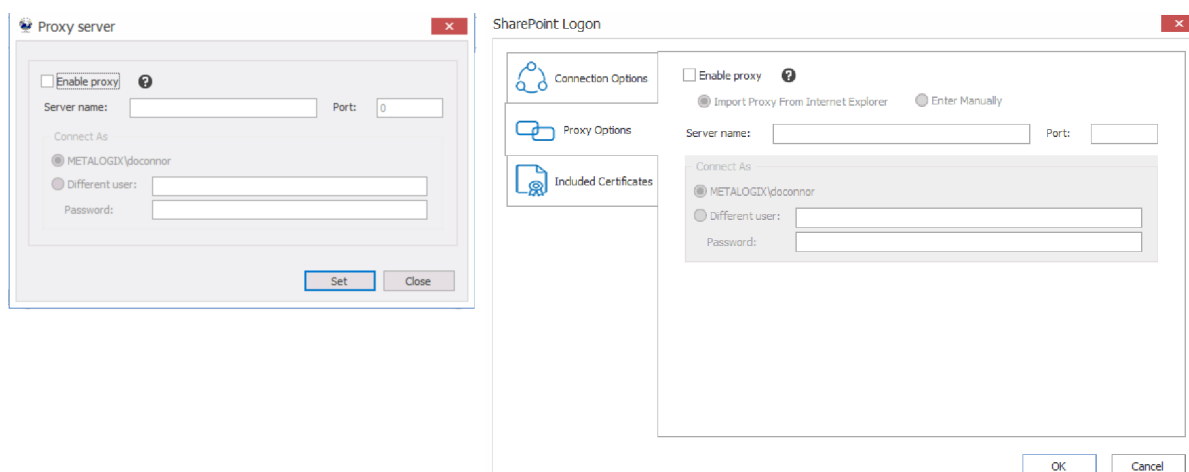

To configure proxy settings:

1. In the Proxy server dialog, check the **Enable proxy** box.

2. Use the information in the following table to determine the appropriate action to take.

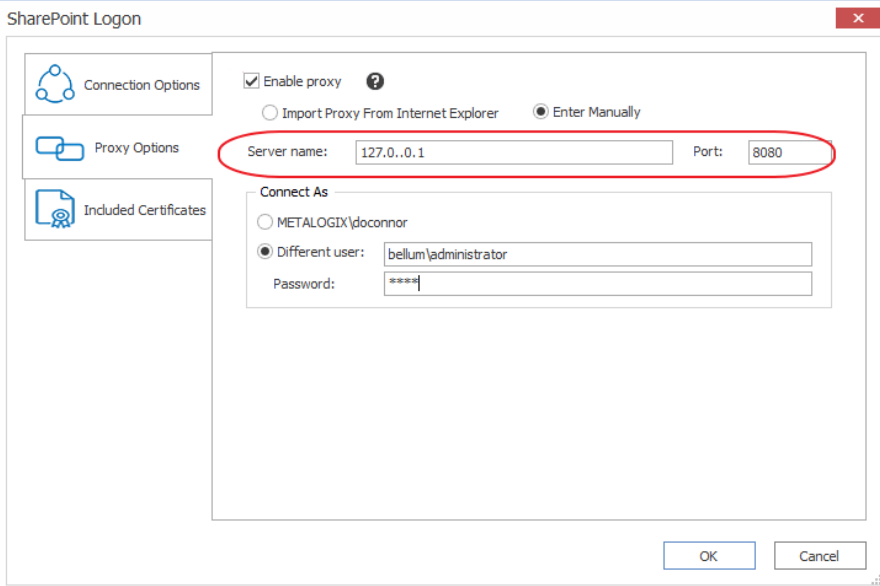
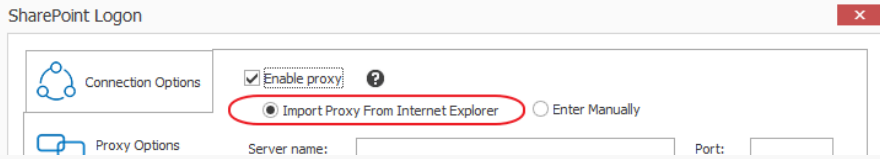
If ...	Then ...
<p>you want to manually enter proxy information</p>	<p>A. Select Enter Manually.</p> <p>B. Enter the Server name (or IP) and Port for the proxy.</p> <p>C. Specify the credentials to be used when connecting to the target server. The Windows authenticated credentials of the current user will be selected by default. You can specify alternate SharePoint credentials by clicking the Different user radio button, and entering an alternate username and password.</p> 
<p>Internet Explorer has been configured to use a proxy server via a proxy auto-configuration (.PAC) file and you want to connect to SharePoint using this method</p>	<p>select Import Proxy from Internet Explorer.</p>  <p>NOTE: This option is currently available only when connecting to SharePoint.</p> <p>Refer to the Microsoft article Auto proxy configuration settings for Internet Explorer for more information.</p>

3. If you accessed the dialog from the License Activation dialog, click **[Set]**.

Restricting Available Actions and Suppressing Events

Content Matrix provides you with the ability to control what actions are available to the client application through configuring on the SharePoint server. Product behaviors can be restricted along three dimensions:

- Available actions
- Unrestricted users
- Suppressed events

Configuring the behavior of the Content Matrix client from target SharePoint servers requires that an XML configuration file be added to the target SharePoint server web application directory. The XML file must be named **ServerAdapterConfig.xml** and placed in the ML folder directory located within the SharePoint hive (this is the same directory where the Metalogix SharePoint Extensions Web Service files are). Below is an example of the typical directory location of the ML folder for SharePoint 2016 and 2019:

```
\\Program Files\Common Files\Microsoft Shared\Web Server Extensions\16\ISAPI\ML
```

ServerAdapterConfig.xml File Format

Below is an example of the simple XML format required for ServerAdapterConfig.xml.

```
<ServerAdapterConfig>
  <DisabledActions>
    <Action>Metalogix.SharePoint.Actions.Migration.PasteSiteAction</Action>
    <Action>Metalogix.SharePoint.Actions.Migration.PasteSiteCollectionAction</Action>
    <Action>Metalogix.SharePoint.Actions.Migration.PasteSiteLists</Action>
    <Action>Metalogix.SharePoint.Actions.Migration.CopyRoleAssignmentsAction</Action>
    <Action>Metalogix.SharePoint.Actions.Migration.CopyWorkflowAssociationsAction</Action>
    <Action>Metalogix.SharePoint.Actions.Migration.PasteFolderAction</Action>
  </DisabledActions>
  <ExemptUsers>
    <User>METALOGIX\geordie</User>
  </ExemptUsers>
</ServerAdapterConfig>
```

```

<User>METALOGIX\julien</User>
</ExemptUsers>
<SuppressEvents>False</SuppressEvents>
</ServerAdapterConfig>

```

There are three main sections within the root **ServerAdapterConfig** section of this XML:

- **DisabledActions:** This section defines the set of actions that cannot be run on the client. See [Actions That Can Be Disabled on the Server Side](#) for a complete list.
- **ExemptUsers:** This section defines the set of users by user name who are exempt from any DisabledActions. In other words, a user in the ExemptUsers is not subject to any restrictions imposed on Content Matrix clients by the DisableActions section.
- **SuppressEvents:** This section defines if any of SharePoint's event receivers are suppressed/disabled during a migration and then restarted once the action is complete. The value for this section is set to "True" by default, but can be manually configured if want event suppression to be disabled. Suppression of event receivers allows Content Matrix to avoid any potential concurrency issues when migrating (mainly with regards to workflows).

Actions That Can Be Disabled

Many of the SharePoint related actions available in the Content Matrix Console can be disabled on the server side. The table below lists the complete set of client actions that can be disabled from the server and provides the format of the action name required in the DisabledActions section of the ServerAdapaterCongifuration.xml file.

NOTE: When an action that is available via the client UI is disabled on the server, it will be visible in client menus but disabled.

Action	Configuration File Format
Change Global Navigation Settings	Metalogix.SharePoint.Actions.Administration.ChangeGlobalNavigationAction
Change Quick Launch	Metalogix.SharePoint.Actions.Administration.ChangeQuickLaunchAction
Create Folder	Metalogix.SharePoint.Actions.Administration.CreateFolderAction
Create List	Metalogix.SharePoint.Actions.Administration.CreateListAction
Create List From XML	Metalogix.SharePoint.Actions.Administration.CreateListFromXMLAction
Create Site	Metalogix.SharePoint.Actions.Administration.CreateSiteAction
Create Site Collection	Metalogix.SharePoint.Actions.Administration.CreateSiteCollection
Create Site Collection in Self-Service Mode	Metalogix.SharePoint.Actions.Administration.CreateSiteCollectionSelfServiceMode
Delete Discussion Item	Metalogix.SharePoint.Actions.Administration.DeleteDiscussionItem

Action	Configuration File Format
Delete Item	Metalogix.SharePoint.Actions.Administration.DeleteFolder
Delete List	Metalogix.SharePoint.Actions.Administration.DeleteItem
Delete Site	Metalogix.SharePoint.Actions.Administration.DeleteList
Delete Site Collection	Metalogix.SharePoint.Actions.Administration.DeleteSite
Export Doc Items	Metalogix.SharePoint.Actions.Administration.DeleteSiteCollection
Publish Documents and Pages	Metalogix.SharePoint.Actions.Administration.PublishDocumentsandPagesAction
Update Site Collection Settings	Metalogix.SharePoint.Actions.Administration.UpdateSiteCollectionSettingsAction
Add Role Assignments	Metalogix.SharePoint.Actions.Migration.AddRoleAssignmentsAction
Copy Folder Permissions	Metalogix.SharePoint.Actions.Migration.CopyFolderPermissions
Copy Item Alerts	Metalogix.SharePoint.Actions.Migration.CopyItemAlertsAction
Copy List Alerts	Metalogix.SharePoint.Actions.Migration.CopyListAlertsAction
Copy List Permissions	Metalogix.SharePoint.Actions.Migration.CopyListPermissions
Copy List Role Assignments	Metalogix.SharePoint.Actions.Migration.CopyListRoleAssignments
Paste Web Parts	Metalogix.SharePoint.Actions.Migration.CopyWebPartsAction
Paste Master Page Gallery	Metalogix.SharePoint.Actions.Migration.CopyMasterPageGalleryAction
Paste Content Types	Metalogix.SharePoint.Actions.Migration.CopySiteContentTypesAction
Paste All Subsites	Metalogix.SharePoint.Actions.Migration.CopySubSitesAction
Copy Web Alerts	Metalogix.SharePoint.Actions.Migration.CopyWebAlertsAction
Copy Web Permissions	Metalogix.SharePoint.Actions.Migration.CopyWebPermissions
Paste Workflow Associations	Metalogix.SharePoint.Actions.Migration.CopyWorkflowAssociationsAction
Paste All List Items	Metalogix.SharePoint.Actions.Migration.PasteAllListItemsAction
Paste All List Items into Items View	Metalogix.SharePoint.Actions.Migration.PasteAllListItemsIntoItemsViewAction
Paste Audiences	Metalogix.SharePoint.Actions.Migration.PasteAudiencesAction
Paste Default Web Part Page	Metalogix.SharePoint.Actions.Migration.PasteDefaultWebPartPageAction

Action	Configuration File Format
Paste Duplicate List	Metalogix.SharePoint.Actions.Migration.PasteDuplicateListAction
Paste Duplicate Site	Metalogix.SharePoint.Actions.Migration.PasteDuplicateSiteAction
Paste Folder	Metalogix.SharePoint.Actions.Migration.PasteFolderAction
Paste List	Metalogix.SharePoint.Actions.Migration.PasteListAction
Paste List as Folder	Metalogix.SharePoint.Actions.Migration.PasteListAsFolderAction
Paste List Email Notifications	Metalogix.SharePoint.Actions.Migration.PasteListEmailNotificationAction
Paste List Item	Metalogix.SharePoint.Actions.Migration.PasteListItemAction
Paste List Item into Items View	Metalogix.SharePoint.Actions.Migration.PasteListItemIntoItemsViewAction
Paste My Sites	Metalogix.SharePoint.Actions.Migration.PasteMySitesAction
Paste Navigation	Metalogix.SharePoint.Actions.Migration.PasteNavigationAction
Paste Roles	Metalogix.SharePoint.Actions.Migration.PasteRolesAction
Paste Site	Metalogix.SharePoint.Actions.Migration.PasteSiteAction
Paste Site Collection	Metalogix.SharePoint.Actions.Migration.PasteSiteCollectionAction
Paste Site Content	Metalogix.SharePoint.Actions.Migration.PasteSiteContentAction
Paste Site Lists	Metalogix.SharePoint.Actions.Migration.PasteSiteLists
Remove Role Assignments	Metalogix.SharePoint.Actions.Migration.RemoveRoleAssignmentAction
Event Suppression	Metalogix.SharePoint.Actions.Migration.SuppressEvents

Note that many of the above listed actions are used by other actions. When a given action is enabled, but one or more of its sub-action is disabled, the sub-actions will not run. When a user attempts to run an action for which sub-actions are disabled, they will be notified with a dialog similar to the following:

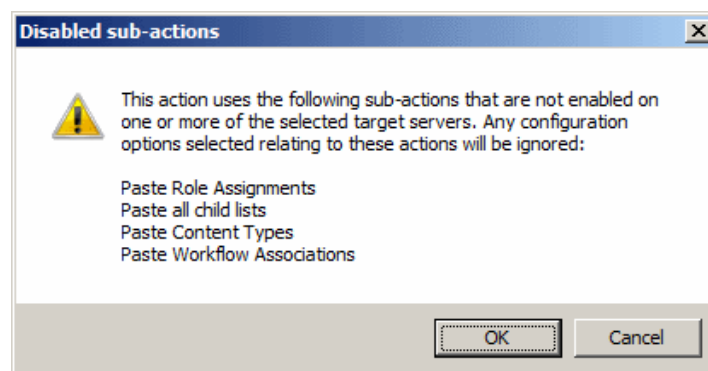

Configuration Variable Files

Content Matrix uses a set of configuration variable files behind the scenes to help set and manage settings for all of the Content Matrix Editions. This section explains what the configuration variable files are, their general behavior, and where to find them.

Configuration variables are contained in the following three files:

- **EnvironmentSettings.xml**
- **UserSettings.xml**
- **ApplicationSettings.xml**

Some settings can be configured for all Product Editions, while other settings are limited to individual Product Editions.

Any settings that are configured in multiple files will be scoped to the lowest level (either in the "UserSettings.xml" file or the "ApplicationSettings.xml" file), including values that are pulled from the old EnvironmentSettings.xml file.

IMPORTANT: Make sure the Content Matrix Console is closed when making updates to configuration variable files.

EnvironmentSettings.xml File

This file allows users to configure general settings for all Product Editions. This means that these settings only need to be set in a single file, either for all users of the machine (if users are required to be local administrators) or for each individual user of the machine (if users are *not* required to be local administrators) and can be found in one of the following locations:

- If you are required to be a local administrator on the machine where Content Matrix is installed: C:\ProgramData\Metalogix

OR

- If you are *not* required to be a local administrator on the machine where Content Matrix is installed: C:\Users\\AppData\Roaming\Metalogix\Common

UserSettings.xml File

This file allows users to configure general settings for all Product Editions for a specific user account (the logged in account). This means that these settings will be configured for all Product Editions, but only for the current user account. If another user would like to configure these same settings to work for them, they must be configured manually under the appropriate user account. It can be found in the following location:

C:\Users\\AppData\Roaming\Metalogix

ApplicationSettings.xml File

This file allows users to configure settings that are limited to the specific Product Edition of Content Matrix Console, for a specific user account (the logged in account). This means that each Product Edition, for every user account, must be configured individually. While the "ApplicationSettings.xml" file for each Product Edition can contain some of the same settings, there are some settings that are Edition specific (for example, some settings may only work for SharePoint Edition, so they will only be available in SharePoint Edition). Any settings that are replicated through various version of the file will only be applied to the specific Edition.

For example, the "AllowCheckResults" setting is available in every "ApplicationSettings.xml" file, but it must be set on an individual Product Edition basis. Setting it for SharePoint Edition will not configure it for Public Folder Edition. It can be found in the following location:

C:\Users\

Client Side Configuration

For an individual Content Matrix Console instance, you can Configure Settings for Migrations Using the Import Pipeline.

Changing Resource Utilization Settings

How many threads can be used simultaneously per job in Content Matrix is controlled by the **Edit Resource Utilization Settings** option, which is accessible from the Settings ribbon at the top of the Console UI.

If the option is clicked, a dialog containing a slider will appear that will allow control of the number of threads available within a single action. If the slider is moved all the way to the left, this will turn off multithreading and only allow a single thread to be used during the action. (For more information on threading, refer to the Microsoft article [About Processes and Threads](#).)

NOTE: Turning off multithreading in this way can be a valuable way of troubleshooting whether multithreading is causing issues.

If the slider is left in the middle, it will allow twice the number of processors in threads to be created per action. For example, if the machine running Content Matrix has a two core CPU, four threads will be able to be used if the slider is in the below state:

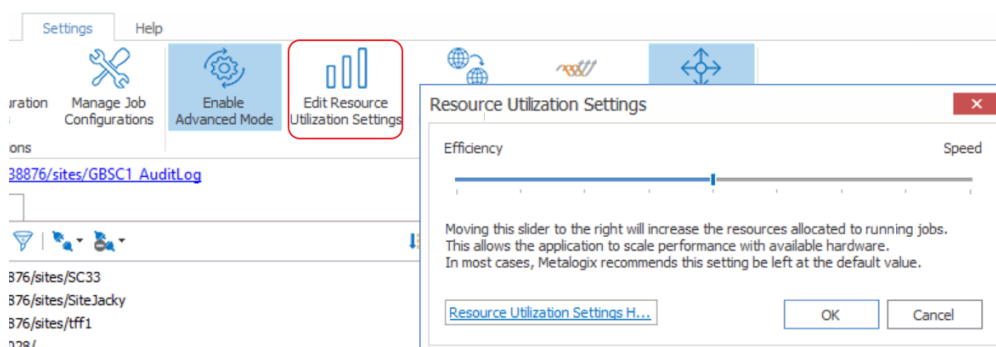

Moving the slider farther to the right will allow more threads to be used, but can potentially overwhelm system resources. This could lead to potential errors if the system resources cannot handle the data being migrated. There is a chance that if the speed is too high, you would see a slowdown in the overall migration, because the migration is trying to run actions faster than the resources properly allow.

While this value can be set through the Content Matrix Console, you can also set it through the back end, if the UI setting does not seem to be working for you. Please contact [Quest Support](#) for more information on this back end setting.

Frequently Asked Questions

This section answers some of the most frequently asked questions about using Content Matrix.

Keyboard Shortcuts

Question

Are there any keyboard shortcuts in the Content Matrix Console? If so, what are they?

Answer

Yes, there are a few basic keyboard shortcuts within the Content Matrix Console. They are:

- **Ctrl + A** - This will **Select All** items within the **Items** view or in any of the logging sections (such as the **Job List** section or the **Log Viewer**).
- **Ctrl + C** - This will **Copy** any selected item(s) within Explorer view or Item view, including sites and lists. It will also copy any selected item(s) or information within the logging sections (such as the **Job List** section or the **Log Viewer**).
- **Ctrl + V** - This will **Paste** any selected item(s) within **Explorer** view or **Item** view, including sites and lists. It will also paste any selected item(s) or information within the logging sections (such as the **Job List** section or the **Log Viewer**).
- **Delete** - This will **Delete** any selected item(s). This applies to all views and items within Content Matrix.
- **Ctrl + P** - This will open the **Properties** dialog for any selected item in Content Matrix, in both the **Explorer** view and the **Items** view.
- **Ctrl + S** - This will open the **Save** dialog for the current Job list.
- **F2 key** - This will **Rename** any selected job list in the **Job List** in the main UI. Simply select the desired job list, in the **Job List** section, press **F2**, and type in the new name for the job list.
- **F5 key** - This will **Refresh** any selected node in the **Explorer** View. This is the same as using the **Refresh** node option in the context (right-click) menu.

Activating the License Key Silently

Question

I would like to activate my license outside of the Content Matrix Console. Is that possible?

Answer

You can activate your Content Matrix license using PowerShell. Follow the steps below.

NOTE: This method can only be used for *online* activations.

1. Open the Content Matrix PowerShell Console.
2. Run the following cmdlet, which includes specifying the Content Matrix Console Edition for which you want to activate the license.

```
if (Get-Command Set-MetalogixJobPrerequisites -ErrorAction SilentlyContinue){ Set-MetalogixJobPrerequisites -Value "Content Matrix Console - <Edition_name>" }
```

NOTE: Valid values for *<Edition Name>* are SharePoint Edition, FileShare Edition and Public Folder Edition. If your license covers more than one Edition, it is only necessary to activate one. The license activation will automatically be applied to any other Edition for which you are licensed.

3. Run the **Set-MetalogixLicense** cmdlet. Note that additional parameters are required if a proxy server is used.

Without proxy server:

```
Set-MetalogixLicense -Key "<license_key>"
```

With proxy server:

```
Set-MetalogixLicense -Key "<license_key>" -ServerUrl "<proxy_server_IP_address>" -Port "<proxy_port_number>" -UserName "<user_account>" -Password "<password>"
```

NOTE: When entering the license key, include hyphens.

License Key Troubleshooting

Question

I have been unable to get Content Matrix to recognize my license key. When I copy and paste it into the box, I get a "the specified license key is invalid" error.

Answer

Here are some things to check:

- Make sure that the license covers the product edition. (For example, if you are licensed for SharePoint Edition and try to activate the license for Public Folder Edition, the invalid error will display.)
- Confirm that the license you are installing is for the correct application versions of Content Matrix. [Contact Quest](#) to verify that it is. (For example, license keys beginning with 823, 824, and 827 are not compatible with File Share Edition since its reintroduction in version 9.9.)
- When performing an offline key activation, make sure to enter the long key in its entirety, including the "=" symbol at the end of it.
- Verify that you have write privileges to the registry. The installer will fail if the registry is locked. In some cases there may be a group policy that is preventing the user from adding the key in the registry, despite the user having the correct permissions.
- Some versions of Windows will automatically block write access to the registry under the user account, even if that account has write access to the registry. In this case you can go to the application installation folder, right click on the application .exe file, and choose 'Run as Administrator'. Then re-enter the license key.

Using Proxies, Load Balancing or Alternate Access Mappings

Question

How does Content Matrix deal with environments that use proxies, load balancing and/or alternate access mappings (AAM)?

Answer

Content Matrix Console should not run into any issues with these three things. Content Matrix uses the **Metalogix Extensions Web Service (MEWS)**, which deploys over a whole farm and functions identically to a regular SharePoint web service. SharePoint web service's get the benefits of IIS redirection, proxy pushing, and anything else that SharePoint can utilize, such as **Alternate Access Mappings (AAM)**. Since the **Metalogix Extensions Web Service** acts the same as a SharePoint web service it also gets all of these benefits.

In the case for load balanced environments the **Metalogix Extensions Web Service** would need to be deployed through the target side SharePoint farm. When the Web Service is installed it automatically

gets deployed to all the SharePoint instances within that farm, as a SharePoint solution. Once the Web Service is installed on the target server, then load balancing should no longer be an issue.

There are, however, some cases where proxy settings may not work correctly by default. In these cases it is possible to set some specific proxy settings for the specified connection. Please see the [Configuring Proxy Settings](#) page for more details.

Errors Connecting to SharePoint 2019 or SharePoint Server Subscription Edition in a FIPS-Enabled Environment

Question

Why am I getting an error when I try to connect to SharePoint 2019 or SharePoint Server Subscription Edition in a FIPS-enabled environment?

Answer

Content Matrix uses some assemblies for FIPS compliance that are not supported for certain SharePoint 2019 and SharePoint Server Subscription Edition connections.

For a remote object model (MEWS) connection (displays for the top node) for SharePoint 2019:

Client found response content type of 'text/html; charset=utf-8', but expected 'text/xml'. The request failed with the error message: -- <!DOCTYPE html> <html>

For a local object model (OM) connection (displays at the item level for SharePoint 2019 and SharePoint Server Subscription Edition):

The type initializer for 'Microsoft.SharePoint.ApplicationRuntime.SPRequestModule' threw an exception

In addition, errors will display in Browser View and Items View.

For SharePoint Server Subscription Edition, you can connect using a remote object model (MEWS) connection.

Changing a Job Configuration for Multiple Files

Question

Is it possible to change the configuration for multiple job files at one time in the **Job List** section of Content Matrix?

Answer

Yes, this is possible. Most users will only need to change the configuration of a single job in the **Job List** section, but it is possible to change the configuration for multiple jobs at one time.

In order to modify the configuration for multiple job files at one, select all of the jobs in the **Job List** section. Once all of the desired jobs are selected there are two methods that can be used to access the configuration dialog. The first is to click the **Change Configuration** button at the top of the **Job List**, and the second method is to open the context (right-click) menu, and select the **Change configuration for selected jobs** option.

The behavior for changing the configuration of multiple files at once changes slightly depending on the version of Content Matrix Console that is being used.

Behavior in Versions 6.1.00 and Later

When changing the configuration for multiple files that use the same type of action at once, only settings that are changed during the re-configuration will be pushed into all of the selected jobs. This means that even if all of the jobs contain different settings, they will all still contain these different settings after the configurations have been modified. Only the settings that were re-configured will be changed (to whatever setting they were changed to).

Let's look at the example of three "Paste Site" jobs that are previously configured, and each has a different **Rename** action applied to it as well as a few various other differences in selected options. When the **Change Configuration** is applied to all three at once, only the settings that were reconfigured will be affected. So if the web part options were changed, then those options will be applied to all three jobs, but each will still retain their original **Rename** setting, and any other settings that were configured even if there are differences.

Behavior in Versions 6.0.0201 and Earlier

When changing the configuration for multiple files that use the same type of action at once, all of the selected files will have the options for the first job in the **Job List** section pushed into them, regardless of any other setting the previously used. Basically, all of the jobs after the first select job in the **Job List** will be modified to use all of the settings from the **Change Configuration** dialog.

Let's look at the example of three "Paste Site" jobs that are previously configured, and each has a different **Rename** action applied to it as well as a few various other differences in selected options. When the **Change Configuration** is applied to all three at once, all of the configuration options that are set for the first of the selected jobs in the **Job List** will be pushed to the two remaining jobs. These two remaining jobs would then use all of the exact same configuration options as the first job, including the values for the rename options. Any of the previous settings for the two remaining jobs would be lost (because they are replaced with the first jobs configuration options).

SharePoint Site Collection Creation Issue

Question

I have been trying to create a new site collection through Content Matrix but I have been encountering issues. Why is this happening? and what can I do about it?

Answer

Starting with SharePoint 2013, most web applications use **claims** authentication, but the Central Administration web application that manages the **server level settings** uses **Classic** authentication. When Content Matrix Console connects to a SharePoint server it has to authenticate through a web application. When connected to a SharePoint 2013 or later web application that uses Claims authentication, SharePoint itself can have trouble recognizing that the accessing User account has permissions in the web application areas that are managed by **Classic** authentication. This is also true if connected to a web application that uses **Classic** authentication, if trying to access an area managed by **Claims** authentication.

The permissions to create site collections is managed by **Classic** authentication, so if connected through a **Claims** authentication web application users will receive a "401 Unauthorized" error message when trying to create a new site collection. This happens even if the user account has all of the appropriate permissions. If connecting through a **Classic** authentication web application, users will receive permission errors when trying to set any settings on a site collection that uses a **Claims** authentication web application, after the site collection is created.



From internal testing, we have determined that SharePoint connections that use the Local Object Model will not run into this issue. This is because the Local OM connection type does not run authentication through IIS, which appears to be a trigger point for the authentication issues.

From testing we have also determined that you are still able to create SharePoint site collections when using the Remote OM connection type, but in order to do this Content Matrix Console must elevate your permissions for the creation step. Before elevating any credentials, Content Matrix Console will run a preliminary check to ensure the migrating user has enough permissions initially to be able to use the elevated site collection creation. In order for these elevated permissions to be used, the migrating user account must explicitly (by name) have "Full Control" permissions on the **Web Application** that the site collection is being created on.

In the Remote OM connection case users can also create a site collection within any **web application** if they are a member of the **Farm Administrator** group in SharePoint **and** they are connected to **Central Administration** as a farm connection.

Possible Errors when Creating Site Collection in SharePoint

Below is a list of errors (and their explanations) that you might encounter when trying to create site collections in SharePoint through Content Matrix Console.

- **Error Message 1** - Unable to obtain Web Application '<web application name>'.
Explanation/Resolution - Content Matrix is unable to find the web application. This should not occur unless a serious issue within SharePoint has occurred from the time the site collection configuration dialog was displayed, and the call to the **Metalogix Extensions Web Service** (for remote OM connections) was made to perform the site collection creation. Check your SharePoint environment, and resolve any issues. Then try again.
- **Error Message2** - Migrating user '<migrating user>' requires explicit Full Control on the web application where the site collection is intended to be created. If the migrating user is a member of the Farm Administrators group then connect to the Central Administration site and try again.

Explanation/Resolution - The migrating user has read permissions on the web application (using a farm or web connection type) that they're connected to, but does not have full control on the web application that they are trying to create the site collection in. To resolve this, the migrating user account must be added explicitly (by name) with **Full Control** to the respective Web Application that they are trying to create the site collection in. They can also create a site collection within any web application if they are a member of the **Farm Administrator** group in SharePoint, and they are connected to Central Administration as a farm connection.

Retrying Failed Document Copies to O365 CSOM Connections

Question

When I try to migrate some of my content into Microsoft 365 using a SharePoint CSOM connection type, and this content contains a large Document Library, I see that some of my documents fail to migrate. The logs for the failure indicate that a "HTTP 500 - Internal Server Error" was thrown. What is the cause of this? And how can I fix it?

Answer

There is a potential issue when migrating specifically to SharePoint Online where users can encounter an "HTTP 500" error. This is caused by a combination of the CSOM adapter and SharePoint's document upload methods. To help resolve this issue there is a document retry feature that can be configured. This retry feature will attempt to upload the document(s) into the SharePoint Online target, and depending on the configured setting, will attempt to retry the upload process if it fails or times-out on the initial try.

The below steps will explain how to enable and configure this retry setting.

NOTE: This retry method is only meant for migrating to SharePoint Online targets. If you are migrating to an on premises target, then this retry feature will not benefit you since it makes use of Microsoft 365 specific methods.

1. Make sure that the Content Matrix client application is closed.
2. In the file system that the Content Matrix Console client application is installed on, navigate to the the appropriate file location:
 - If you *are* required to be a local administrator on the machine where Content Matrix is installed:
C:\ProgramData\Metalogix

OR

- If you are *not* required to be a local administrator on the machine where Content Matrix is installed: C:\Users\\AppData\Roaming\Metalogix\Common
3. In this location there should be an **EnvironmentSettings.xml** file. Open this file in an editor program. For example, Notepad, etc.
 4. There are two variables that will need to be modified in order for the retry method to work. They are:
 - **CSOMDocumentRetriesNumber** - This value determines the number of times that Content Matrix will make another attempt to upload/migrate any document(s) that has failed the initial document upload try, when migrating to a SharePoint Online CSOM target.
 - **CSOMDocumentRetriesDelay** - This value determines the amount of time, in seconds (s), that Content Matrix will wait before starting a document upload retry, and is based on the above ("CSOMDocumentRetriesNumber") variable.

NOTE: The default values for these two variables will be set as "0". Users can set these values as desired, based on what works best for their environment.

5. After the desired values have been entered in the two variables, save and close the file.
6. Restart the Content Matrix client application. The changes should now be in Content Matrix Console, and used when running any migration to a SharePoint Online target environment.

After these values have been set and the client application has been restarted, any documents that fail on the initial migration attempt will be retried.

When Migrating to SharePoint Online HTTP Status Code 429 (“Too many requests”) or 503 (“Server Too Busy”) Message Returned

Question

When migrating to SharePoint Online, why do I receive one or both of the following messages?

- 429 (“Too many requests”)
- 503 (“Server Too Busy”)

Answer

SharePoint Online uses throttling to maintain optimal performance and reliability of the SharePoint Online service.

As of version 9.8, Content Matrix has incorporated the use of RateLimit headers developed by Microsoft to reduce throttling.

Refer to the Microsoft article [Avoid getting throttled or blocked in SharePoint Online](#) for a description of RateLimit headers and additional tips on how to avoid throttling.

Error Making a Browser-Based Connection with PowerShell Console Open

Question

Why do I get a "Manual Reconnection Required" error when I try to run a Content Matrix job using PowerShell?

Answer

This error would occur if you used the Content Matrix Console to connect to a SharePoint target with **Web Browser Authentication** while the PowerShell console is open. To avoid this issue, take the following steps:

1. Make sure that the PowerShell console is closed at the time you make a target connection via the Content Matrix Console when Web Browser Authentication is used.

NOTE: After entering your credentials, be sure to check the **Remember my Password** box, as credentials must be stored in the Credential Manager vault before the connection is made.

2. After you have created your PowerShell job, close the Content Matrix Console.

NOTE: At this point, it is recommended that you remove your Web Browser Authentication credentials from Windows Credential Manager. You will be prompted to re-enter them when the PowerShell job is run.

3. Launch the PowerShell console and run the job.
4. When prompted, re-enter the credentials you used to connect via the Content Matrix Console. (Again, remember to check the **Remember my password** box.)

Error: 'The object is associated with property AssociatedMemberGroup.'

Question

When migrating an object to a SharePoint Online site or OneDrive, why do I receive the following error?

Object reference not set to an instance of an object on server. The object is associated with property AssociatedMemberGroup.

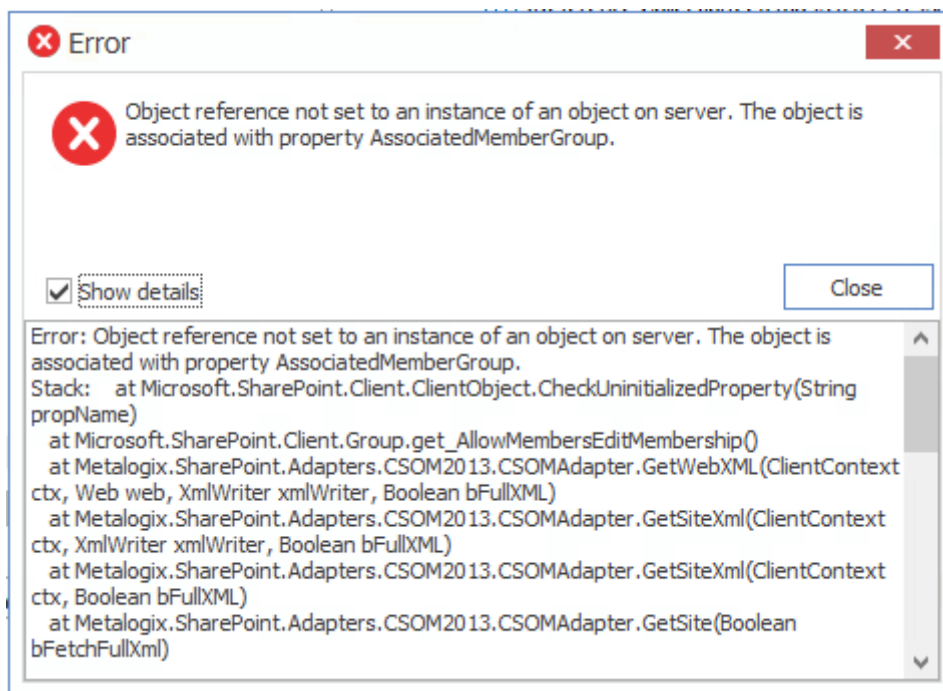

Answer

This error may occur when one or more of the default SharePoint groups (Owners, Members, and/or Visitors) are not present on the target.

NOTE: For OneDrives, none of these groups are present by default.

Create the missing default group(s) on the target. Refer to the applicable [Content Matrix Knowledge Base article](#) for more information.

Support for GCC High Tenants

Question

Does Content Matrix support SharePoint Online GCC High connections?

Answer

Refer to the following table for specific target connections that Content Matrix supports for GCC High tenants.

IMPORTANT: In order to use ADFS authentication with a GCC High tenant you must first run a utility provided by Quest Support and enable the setting **EnableUserProvidedAuthentication**. Refer to the Quest Support Knowledge Base article [Enabling User Provided Authentication in Content Matrix](#) for details.

OAuth	OAuth with MFA	ADFS	ADFS (Microsoft 365 User Provided Authentication)	Web Browser Authentication	Microsoft 365 Web Browser Authentication
--	✓	--	--	✓	✓
--	✓	--	✓	✓	✓

About Us

Quest creates software solutions that make the benefits of new technology real in an increasingly complex IT landscape. From database and systems management, to Active Directory and Microsoft 365 management, and cyber security resilience, Quest helps customers solve their next IT challenge now. Around the globe, more than 130,000 companies and 95% of the Fortune 500 count on Quest to deliver proactive management and monitoring for the next enterprise initiative, find the next solution for complex Microsoft challenges and stay ahead of the next threat. Quest Software. Where next meets now. For more information, visit www.quest.com.

Contacting Quest

For sales or other inquiries, visit www.quest.com/contact.

Technical Support Resources

Technical support is available to Quest customers with a valid maintenance contract and customers who have trial versions. You can access the Quest Support Portal at <https://support.quest.com>

The Support Portal provides self-help tools you can use to solve problems quickly and independently, 24 hours a day, 365 days a year. The Support Portal enables you to:

- Submit and manage a Service Request
- View Knowledge Base articles
- Sign up for product notifications
- Download software and technical documentation
- View how-to-videos
- Engage in community discussions
- Chat with support engineers online
- View services to assist you with your product

