

Quest® Enterprise Reporter 3.2.1  
**Quick Start Guide**



© 2019 Quest Software Inc.

**ALL RIGHTS RESERVED.**

This guide contains proprietary information protected by copyright. The software described in this guide is furnished under a software license or nondisclosure agreement. This software may be used or copied only in accordance with the terms of the applicable agreement. No part of this guide may be reproduced or transmitted in any form or by any means, electronic or mechanical, including photocopying and recording for any purpose other than the purchaser's personal use without the written permission of Quest Software Inc.

The information in this document is provided in connection with Quest Software products. No license, express or implied, by estoppel or otherwise, to any intellectual property right is granted by this document or in connection with the sale of Quest Software products. EXCEPT AS SET FORTH IN THE TERMS AND CONDITIONS AS SPECIFIED IN THE LICENSE AGREEMENT FOR THIS PRODUCT, QUEST SOFTWARE ASSUMES NO LIABILITY WHATSOEVER AND DISCLAIMS ANY EXPRESS, IMPLIED OR STATUTORY WARRANTY RELATING TO ITS PRODUCTS INCLUDING, BUT NOT LIMITED TO, THE IMPLIED WARRANTY OF MERCHANTABILITY, FITNESS FOR A PARTICULAR PURPOSE, OR NON-INFRINGEMENT. IN NO EVENT SHALL QUEST SOFTWARE BE LIABLE FOR ANY DIRECT, INDIRECT, CONSEQUENTIAL, PUNITIVE, SPECIAL OR INCIDENTAL DAMAGES (INCLUDING, WITHOUT LIMITATION, DAMAGES FOR LOSS OF PROFITS, BUSINESS INTERRUPTION OR LOSS OF INFORMATION) ARISING OUT OF THE USE OR INABILITY TO USE THIS DOCUMENT, EVEN IF QUEST SOFTWARE HAS BEEN ADVISED OF THE POSSIBILITY OF SUCH DAMAGES. Quest Software makes no representations or warranties with respect to the accuracy or completeness of the contents of this document and reserves the right to make changes to specifications and product descriptions at any time without notice. Quest Software does not make any commitment to update the information contained in this document.

If you have any questions regarding your potential use of this material, contact:

Quest Software Inc.  
Attn: LEGAL Dept.  
4 Polaris Way  
Aliso Viejo, CA 92656

Refer to our website (<https://www.quest.com>) for regional and international office information.

**Patents**

Quest Software is proud of our advanced technology. Patents and pending patents may apply to this product. For the most current information about applicable patents for this product, please visit our website at <https://www.quest.com/legal>.

**Trademarks**

Quest, the Quest logo, and Join the Innovation are trademarks and registered trademarks of Quest Software Inc. For a complete list of Quest marks, visit <https://www.quest.com/legal/trademark-information.aspx>. All other trademarks and registered trademarks are the property of their respective owners.

**Legend**

- **WARNING:** A WARNING icon indicates a potential for property damage, personal injury, or death.
  
- ⚠ **CAUTION:** A CAUTION icon indicates potential damage to hardware or loss of data if instructions are not followed.
  
- ⓘ **IMPORTANT NOTE, NOTE, TIP, MOBILE, or VIDEO:** An information icon indicates supporting information.

# Contents

Introducing Quest® Enterprise Reporter	4
Key Features of Enterprise Reporter	4
Enterprise Reporter Components	5
Enterprise Reporter Architecture	6
System Requirements	6
Hardware Requirements	7
New Required Hardware	8
Supported Operating Systems	9
Active Roles Supported Versions	11
IT Security Search Supported Versions	12
SQL Server Supported Versions	12
New Required Software	13
Required Software	13
Required Services	15
An Overview of Enterprise Reporter Communications and Credentials Required	15
Node Credential and Alternate Credential Details for On-Premises Discoveries	16
Detailed Permissions for Enterprise Reporter Discoveries	19
Permissions for Enterprise Reporter Discoveries on NAS Devices	21
Permissions for Enterprise Reporter Tenant Applications	21
Minimum Permissions for Initially Installing Enterprise Reporter	23
Port Requirements	24
Installing Enterprise Reporter	31
Create/Connect Your Enterprise Reporter Database	32
Configure Enterprise Reporter Licenses	33
Activating or Updating Your License	34
Create Your First Enterprise Reporter Cluster and Node	34
Step-By-Step Walkthroughs	36
Pre- and Post-Migration Assessment	36
Manage Compliance	38
Change History Reporting	42
File Storage Consolidation	45
Office 365 and Azure Reporting	48
<b>About us</b>	<b>52</b>

# Introducing Quest<sup>®</sup> Enterprise Reporter

Quest Enterprise Reporter provides administrators, security officers, help desk staff, and other stakeholders with insight into their network environment. Reporting on your network environment provides:

- General visibility into the security and configuration of your environment.
- Validation against your security policies to ensure objects are configured as expected. This helps you detect security violations such as identifying users with inappropriate access.
- An easy way to respond to inquiries from internal and external auditors requesting security and configuration information.

Enterprise Reporter provides scalability, security, and customizability by:

- Allowing you to deploy Enterprise Reporter to take advantage of both your network structure and available hardware or virtual computers. You can scale your deployment up or down as your needs change.
- Separating data collection from reporting, allowing less technical users to easily generate the reports they need from stored data.
- Using role-based security to provide and revoke access to your Quest Enterprise Reporter deployment.
- Providing granular credentials management, allowing you to access information using different accounts for performing different tasks and accessing different parts of your environment. Accounts are stored in a central Credential Manager, making it easy for you to see what accounts are in use and to keep them up to date.
- Providing a full featured report designer. You can easily customize the included reports by adding attributes and using advanced filtering, or you can build new reports to satisfy the unique requirements of your organization.
- Automating the collection of data and the generation and delivery of reports.

## Key Features of Enterprise Reporter

Organizations worldwide are struggling to keep up with corporate policies, changing government regulations, and industry standards. Generating reports that prove compliance, and deciding what data to include is a time consuming and difficult process. In order to meet compliance requirements or initiate IT best practices, organizations must know exactly what is in the IT infrastructure at any moment in time, how it is configured, and who has access to it. Quest presents Enterprise Reporter as a solution to these problems.

Enterprise Reporter provides a unified solution for data discovery and report generation. Using the Enterprise Reporter Configuration Manager, administrators can easily configure and deploy discoveries to collect and store data. Once the data has been collected, the Report Manager allows users to produce reports that help organizations to ensure that they comply with industry regulations and standards, adhere to internal security policies, monitor hardware and software requirements, and fulfill many other reporting requirements.

Using the Configuration Manager, you can:

- Configure your collection environment to minimize network traffic and optimize performance.
- Create discoveries to collect data that will be made available to the Report Manager:
  - information about your Active Directory<sup>®</sup> environment
  - information about files and folders from domains, OUs, computers, NetApp<sup>®</sup> and EMC<sup>®</sup> filers, shares, and DFS shares
  - information about the computers in your environment
  - data from specified SQL Server<sup>®</sup> computers, instances, and databases
  - general and registry information from selected computers

- high-level summary information on file storage
  - high-level summary information and permissions in your Exchange® environment
  - information about your Azure® subscriptions, licenses, and service plans
  - information about your Azure Active Directory® environment
  - information about your Azure® resources
  - information about files and folders in your OneDrive® environment
  - information about your Office 365® Exchange Online environment
  - information about your Microsoft Teams in Office 365®
- Schedule discoveries to run automatically.
  - Track the progress of discoveries, and pinpoint any errors in the collection.

Using the Report Manager, you can:

- Run reports on the data you have collected.
- Make predefined reports available to reporting users by publishing them.
- Create your own customized reports.
- Customize the appearance of your reports.
- Schedule reports to run when you need them.
- Publish reports to Knowledge Portal.
- Use the File Storage Analysis summary reports, with meaningful charts and graphs and the ability to drill down for more detailed information, to answer challenging administrative questions about file storage.
- Use the Exchange® summary reports, with meaningful charts and graphs and the ability to drill down for more detailed information, to answer challenging administrative questions about your Exchange® environments.
- Use the Exchange® reports to monitor and update the access permissions of accounts in an efficient and timely manner to ensure mailbox information security.
- Use the OneDrive® reports to answer questions about file and folder permissions in your OneDrive® environment.
- Use the Azure® reports to answer questions about your Azure® subscriptions, licenses, and settings.
- Use the Azure Active Directory® reports to answer questions about your Azure Active Directory® environment.
- Use the Azure® resource reports to answer questions about your Azure® resources.
- Use the Office 365 Exchange® Online reports to answer questions about your Exchange® Online mailbox, mailbox folders, and public folders and their permissions.
- Use the Microsoft Teams reports to answer questions about your Microsoft Teams in Office 365®.

## Enterprise Reporter Components

An Enterprise Reporter deployment includes (at minimum):

- An Enterprise Reporter server and database
- At least one Configuration Manager installation
- At least one deployed node

- At least one Report Manager installation

For information on installation, see [Installing Enterprise Reporter](#) on page 31.

## Enterprise Reporter Architecture

Figure 1. Enterprise Reporter architecture

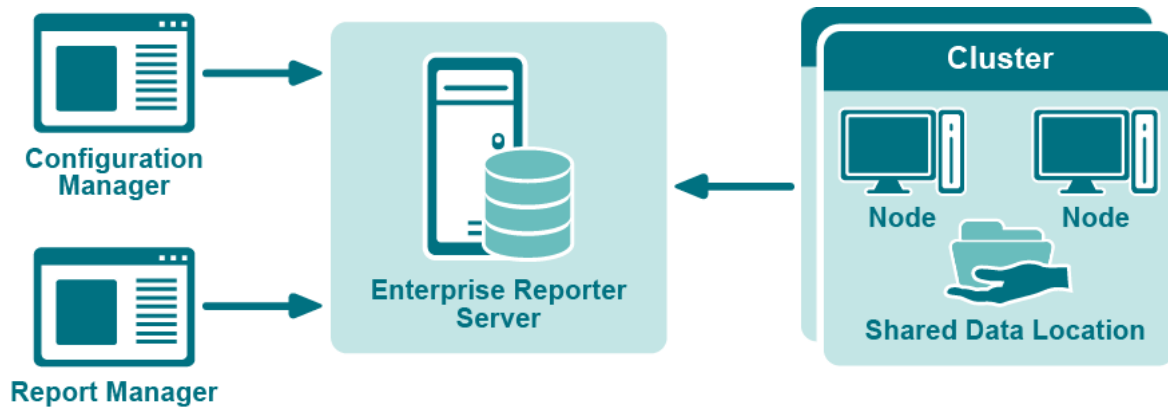

## System Requirements

Before installing Enterprise Reporter 3.2.1, ensure that your system meets the following minimum hardware and software requirements.

See also:

- [Hardware Requirements](#)
- [New Required Hardware](#)
- [Supported Operating Systems](#)
- [Active Roles Supported Versions](#)
- [IT Security Search Supported Versions](#)
- [SQL Server Supported Versions](#)
- [New Required Software](#)
- [Required Software](#)
- [Required Services](#)

# Hardware Requirements

## Enterprise Reporter Server

For the Enterprise Reporter Server, we recommend the following minimum hardware.

Table 1. Enterprise Reporter Server Hardware Requirements

Component	Recommended specifications
Memory	<ul style="list-style-type: none"><li>• Minimum: 8 GB RAM</li><li>• Recommended: 16 GB RAM</li></ul>
Processor	<ul style="list-style-type: none"><li>• Intel® or AMD 2 GHz multiprocessor (with at least 2cores)</li><li>• 64-bit processor</li></ul>
Hard disk space	<ul style="list-style-type: none"><li>• 10 GB</li><li>• The file share used for the optional Shared Data Location requires space for storage of collected data. Space requirements vary with the amount of data collected.</li></ul>

## Configuration Manager and Report Manager

For the Configuration Manager and Report Manager, we recommend the following minimum hardware.

Table 2. Configuration Manager and Report Manager Hardware Requirements

Component	Recommended specifications
Memory	<ul style="list-style-type: none"><li>• Minimum: 16 GB RAM</li><li>• Recommended: 16 GB RAM</li></ul>
Processor	<ul style="list-style-type: none"><li>• Intel® or AMD 2 GHz multiprocessor (with at least 2 cores)</li><li>• 64-bit processor</li></ul>
Hard disk space	<ul style="list-style-type: none"><li>• Configuration Manager: 2 GB</li><li>• Report Manager: 20 GB</li></ul>

## Enterprise Reporter Nodes

For the Enterprise Reporter Nodes, we recommend the following minimum hardware. For more detailed recommendations for node requirements, see *Optimize Node Setup* in the Quest Enterprise Reporter Installation and Deployment Guide in the [Technical Documentation](#).

Table 3. Node Hardware Requirements

Component	Recommended specifications
Memory	<ul style="list-style-type: none"><li>• Minimum: 16 GB RAM</li><li>• Recommended: 16 GB RAM</li></ul>
Processor	<ul style="list-style-type: none"><li>• Intel® or AMD 2 GHz multiprocessor (with at least 2 cores - 4 recommended)</li><li>• 64-bit processor</li></ul>
Hard disk space	<ul style="list-style-type: none"><li>• 10 GB for installed files plus 10-100 GB extra space for processing collections</li></ul>

# Enterprise Reporter SQL Server

For the Enterprise Reporter SQL Server, we recommend the following minimum hardware.

Table 4. SQL Server Hardware Requirements

Component	Recommended specifications
Memory	<ul style="list-style-type: none"><li>• Minimum: 16 GB RAM</li><li>• Recommended: 24 GB RAM</li></ul>
Processor	<ul style="list-style-type: none"><li>• Intel® or AMD 2 GHz multiprocessor (with at least 4cores)</li><li>• 64-bit processor</li></ul>
Hard disk space	<ul style="list-style-type: none"><li>• 100 GB or more for larger environments</li></ul>

**NOTE:** SQL Server performance is needed to support inserting data into the database tables and to support querying that data for reporting purposes. To improve the performance of data collection or reporting, consider enhancing the SQL Server memory and processor.

## Database Size Estimator

The Enterprise Reporter database is the storage location of all data collected for reporting. As such, the amount of hard disk space required is directly related to the amount of data being collected. The Database Size Estimator tool shipped with Enterprise Reporter can help determine how much space will be required.

## Larger Environments

Larger environments may have additional requirements for memory, processor, and hard disk space. There are many factors that can affect these requirements.

- The type of collections being performed.

Some discoveries collect many object types and attributes that require multitudes of inserts into multiple database tables; therefore, they require a more robust SQL Server. Other discoveries collect just a few object types that require minimal inserts into a few database tables; therefore, they require a less robust SQL server.

For example, A computer discovery collecting 10,000 computers will be inserting into 20+ database tables. An NTFS discovery collecting 10,000 files and folders will only be inserting into 3 database tables. The inserts are more expensive and the computer discovery will require more SQL server resources.

- The size of collections being performed.

The size of the database directly relates to the amount of data being collected and being queried from the SQL Server. In other words, the size of the database directly relates to the number of rows in the database. Each discovery type stores different amounts of data. Use the Database Estimator tool for further information based on the types of collections being performed.

- The location of the SQL Server in relation to the collection targets.

The power of your SQL Server combined with the performance of your network will dictate how fast data can be sent and retrieved from the database. The further away the SQL server is from collection targets and the slower the network speeds, the more a robust SQL Server will help improve performance.

## New Required Hardware

The following hardware is required for Enterprise Reporter 3.2.1 and higher.

- Intel® or AMD 2 GHz multiprocessor (with at least 2 cores)



# Supported Operating Systems

The following operating systems are supported for Enterprise Reporter components.

**i** | **NOTE:** It is not recommended that the server or console be installed on a domain controller.

**Table 5. Supported Operating Systems**

Operating Systems	ER Server	Consoles	Nodes
	Enterprise Reporter		
Windows Server® 1903	X		X
Windows Server® 2019	X	X	X
Windows Server® 1809	X		X
Windows Server® 2016	X	X	X
Windows Server® 1803	X		X
Windows Server® 2012 R2	X	X	X
Windows Server® 2012	X	X	X
Windows Server® Core 2012 R2	X		X
Windows Server® Core 2012 R2 Cluster	X		X
Windows Server® Core 2012	X		X
Windows Server® Core 2012 Cluster	X		X
Windows Server® 2008 R2 with Service Pack 1	X	X	X
Windows Server® Core 2008 R2 with Service Pack 1	X		X
Windows Server® Core 2008 R2 with Service Pack 1 (64-bit) Cluster	X		X
Windows Server® 2008 with Service Pack 2 (64-bit)	X	X	X
Windows® 10		X	
Windows® 8.1		X	
Windows® 8 (64-bit)		X	
Windows® 7 with Service Pack 1 (64-bit)		X	
Windows Vista® with Service Pack 2 (64-bit)		X	

The following operating systems are supported for Enterprise Reporter discovery targets.

**Table 6. Supported Operating Systems for Discovery Targets**

Supported Operating Systems for Discovery Targets	Active Directory	Windows Server	File Storage Analysis	SQL Server	Exchange
	L i c e n c e s				
<b>Domain Functional Levels</b>					
Windows Server® 2019 Functional Level	X				
Windows Server® 2016 Functional Level	X				
Windows Server® 2012 R2 Functional Level	X				
Windows Server® 2012 Functional Level	X				
Windows Server® 2008 R2 Functional Level	X				
Windows Server® 2008 Functional Level	X				
Windows Server® 2003 Functional Level	X				
<b>Computers</b>					
Windows Server® 1903		X	X		
Windows Server® 2019 and 1809		X	X		
Windows Server® 2016 and 1803		X	X		
Windows Server® 2012 R2		X	X		
Windows Server® 2012		X	X		
Windows Server® Core 2012		X	X		
Windows Server® 2008 R2 with Service Pack 1		X	X		
Windows Server® Core 2008 R2 with Service Pack 1		X	X		
Windows Server® 2008 with Service Pack 2 (64-bit and 32 bit)		X	X		
Windows Server® 2003 R2 with Service Pack 2 (64-bit)		X	X		
Windows Server® 2003 with Service Pack 2 (64-bit and 32 bit)		X	X		
Windows® 10		X	X		
Windows® 8.1		X	X		
Windows® 8 (64-bit and 32 bit)		X	X		
Windows® 7 with Service Pack 1 (64-bit and 32 bit)		X	X		
Windows Vista® with Service Pack 2 (64-bit and 32 bit)		X	X		
Windows® XP Professional with Service Pack 3 (64-bit and 32 bit)		X	X		
<b>Network Attached Storage (NAS) Devices</b>					
Dell Fluid File System 6.0		X	X		
Dell Fluid File System 5.0		X	X		
NetApp® 9.4		X	X		

Supported Operating Systems for Discovery Targets	Active Directory	Windows Server	File Storage Analysis	SQL Server	Exchange
	L i c e n c e s				
NetApp® 9.3		X	X		
NetApp® Filer - Data ONTAP® 8..x - 9.x and above (Cluster mode is supported as of version 8.2)		X	X		
EMC Isilon OneFS (Collections require a secure connection to Isilon with a valid certificate.)		X	X		
EMC® VNX 7.1.47.5 X (Supported by collecting as a Windows Server)		X	X		
EMC® VNX 7.0.35.3 X (Supported by collecting as a Windows Server)		X	X		
<b>SQL Server Instances</b>					
SQL Server® 2017				X	
SQL Server® Clusters				X	
SQL Server® 2016				X	
SQL Server® 2014				X	
SQL Server® 2012				X	
SQL Server® 2008 R2				X	
SQL Server® 2008 with Service Pack 2				X	
SQL Server® 2005 with Express Service Pack 3				X	
SQL Server® 2005 with Service Pack 3				X	
<b>Exchange Servers</b>					
Exchange® 2019					X
Exchange® 2016					X
Exchange® 2013					X
Exchange® 2010					X
Exchange® 2007					X
Exchange® Mixed Modes (2007-2010, 2010-2013, 2007-2013)					X

## Active Roles Supported Versions

The following versions of Active Roles are supported as targets of Active Directory discoveries. See the Active Roles web site for the hardware and software requirements for your version of Active Roles.

- Active Roles 7.3
- Active Roles 7.2.1
- Active Roles 7.1.2
- Active Roles 7.0.4
- Active Roles 7.0.2

- Active Roles 6.9.0

## IT Security Search Supported Versions

Enterprise Reporter can be configured to send discovery information to the following versions of IT Security Search. See the IT Security Search web site for the hardware and software requirements for your version of IT Security Search.

- IT Security Search 11.4
- IT Security Search 11.3

## SQL Server Supported Versions

The following versions of SQL Server<sup>®</sup> are supported for the Enterprise Reporter database. See the Microsoft<sup>®</sup> web site for the hardware and software requirements for your version of SQL Server<sup>®</sup>:

- SQL Server<sup>®</sup> 2017
- SQL Server<sup>®</sup> 2016
- SQL Server<sup>®</sup> 2014
- SQL Server<sup>®</sup> 2012
- SQL Server<sup>®</sup> 2008 R2
- SQL Server<sup>®</sup> 2008 with Service Pack 2
- SQL clusters and database mirroring are supported for your deployment, including
  - SQL Server<sup>®</sup> 2016 Always On
  - SQL Server<sup>®</sup> 2014 Always On
  - SQL Server<sup>®</sup> 2012 Always On

## Using SQL Server Certificates

### SSL Encryption of SQL Server Connections using Certificates

Enterprise Reporter can be configured to work with a SQL Server<sup>®</sup> instance. To secure communications while working with Enterprise Reporter, data sent over connections to the SQL Server can be encrypted using an SSL certificate.

The steps required to configure this encryption are as follows.

- Using the Microsoft Management Console (MMC):
  - install the Certificates snap-in for the SQL Server<sup>®</sup> host computer
  - import the certificate to the SQL Server<sup>®</sup> host computer
- Using SQL Server Configuration manager:
  - configure the SQL Server<sup>®</sup> to use the certificate
  - configure the SQL Server<sup>®</sup> to force encryption
- Restart the SQL Server<sup>®</sup> host computer

- Import the certificate to all Enterprise Reporter computers that will need to communicate with the SQL Server®, such as:
  - Enterprise Reporter server host computer
  - Enterprise Reporter nodes
  - Enterprise Reporter Configuration Manager host computer
  - Enterprise Reporter Report Manager host computer
- Install Enterprise Reporter on a host computer

## New Required Software

The following software is required for Enterprise Reporter 3.2.1 and higher.

- PowerShell™ 3.0
- Microsoft® .NET Framework 4.6
- Microsoft SharePoint Online Management Shell

**i** | **NOTE:** PowerShell 3.0 and Microsoft SharePoint Online Management Shell are required on the node machines to collect OneDrive configuration settings.

**NOTE:** In addition, for OneDrive configuration settings to be collected successfully, an authorized connection must be established to the SharePoint Online service. To allow for credentials to be specified for your tenant, the “LegacyAuthProtocols” setting must be enabled on your tenant. To set this on your tenant, run the following commands using the Microsoft SharePoint Online Management Shell. This action must be performed on any node machine with Microsoft SharePoint Online Management Shell installed.

```
Set-ExecutionPolicy -Scope Process -ExecutionPolicy RemoteSigned
Import-Module -Name Microsoft.Online.SharePoint.PowerShell
Connect-SPOService -Url "https://<tenant>-admin.sharepoint.com"
Set-SPOTenant -LegacyAuthProtocolsEnabled $True
Disconnect-SPOService
```

- Microsoft Azure Active Directory Module for Windows PowerShell

**i** | **NOTE:** Microsoft Azure Active Directory Module for Windows PowerShell is required on the node machines to collect multi-factor authentication attributes for Azure Users.

## Required Software

The following software is required for Enterprise Reporter.

- Microsoft® .NET Framework 4.6
- Microsoft® .NET Framework 4.0 (Full)
- Microsoft® .NET Framework 3.5 Service Pack 1
- Microsoft® Excel® (required to view reports exported as spreadsheets)
- Microsoft® Excel® 2010
- Microsoft® Excel® 2013
- PowerShell™ 3.0

## Active Roles Required Software

To collect Active Roles information, the following software is required on the computer where the Enterprise Reporter Configuration Manager is installed and on the computer where the Enterprise Reporter node is installed:

- ADSI Provider (the version must match the Active Roles version)

For more information and installation instructions, see the Active Roles Quick Start Guide.

The following additional considerations are required:

- There must be a trust between the Enterprise Reporter domain and the Active Roles domain.
- The credentials used for the Active Roles discovery must have access to the Active Roles domain.

## Exchange Required Software

To collect Exchange information, the following additional considerations are required:

- Ensure the Windows Remote Management (WinRM) service is running.

To collect Exchange<sup>®</sup> 2007 information, the following additional considerations are required:

- Exchange<sup>®</sup> 2007 Management Tools must be installed on the computer where the Enterprise Reporter node is installed and must be in the same forest as the 2007 Exchange Organization.
- It is highly recommended to put the computer where the Enterprise Reporter node is installed within the target Exchange<sup>®</sup> 2007 domain.

To collect Exchange mailbox folders, the following additional considerations are required:

- Impersonation needs to be configured on the Exchange organization. Refer to your Exchange Server documentation or use the following method to set up role assignments.
  - Powershell can be used to add an assignment  
New-ManagementRoleAssignment -Name:impersonationAssignmentAdministrator  
-Role:ApplicationImpersonation -User:Administrator
  - Alternatively, you can create an administrator role with ApplicationImpersonation role assigned to it and add the required account as a member (or assign ApplicationImpersonation role to an existing administrator role)

## Azure Required Software

To collect Azure information, the following additional software is required:

- Microsoft Azure Active Directory Module for Windows PowerShell
  - **NOTE:** Microsoft Azure Active Directory Module for Windows PowerShell is required on the node machines to collect multi-factor authentication attributes for Azure Users.

## Exchange Online Required Software

To collect Exchange Online information, the following additional considerations are required:

- Ensure the Windows Remote Management (WinRM) service is running.

## OneDrive Required Software

To collect OneDrive information, the following additional software is required:

- Microsoft SharePoint Online Management Shell

**i** **NOTE:** PowerShell 3.0 and Microsoft SharePoint Online Management Shell are required on the node machines to collect OneDrive configuration settings.

**NOTE:** In addition, for OneDrive configuration settings to be collected successfully, an authorized connection must be established to the SharePoint Online service. To allow for credentials to be specified for your tenant, the “LegacyAuthProtocols” setting must be enabled on your tenant. To set this on your tenant, run the following commands using the Microsoft SharePoint Online Management Shell. This action must be performed on any node machine with Microsoft SharePoint Online Management Shell installed.

```
Set-ExecutionPolicy -Scope Process -ExecutionPolicy RemoteSigned
Import-Module -Name Microsoft.Online.SharePoint.PowerShell
Connect-SPOService -Url "<full tenant name>"
Set-SPOTenant -LegacyAuthProtocolsEnabled $True
Disconnect-SPOService
```

## Required Services

The following services are required on the Enterprise Reporter server and nodes.

- Net.TCP Port Sharing

The following services must be enabled on discovery targets for collections.

- Remote Registry
- SQL Server Browser service for SQL Discovery
- Windows Management Instrumentation (WMI)

# An Overview of Enterprise Reporter Communications and Credentials Required

There are many communication channels in Enterprise Reporter, involving different sets of credentials. This allows for controlled access to your environment, but you must understand where each set of credentials are used, and what permissions they need.

[Figure 2](#) outlines where and for what each of the credentials are used, and the following tables explain the necessary permissions. For information on managing the credentials used in the Configuration Manager, see the *Using the Credential Manager* section in the Quest Enterprise Reporter Configuration Manager User Guide in the [Technical Documentation](#).

Figure 2. Credentials used to communicate in the Configuration Manager

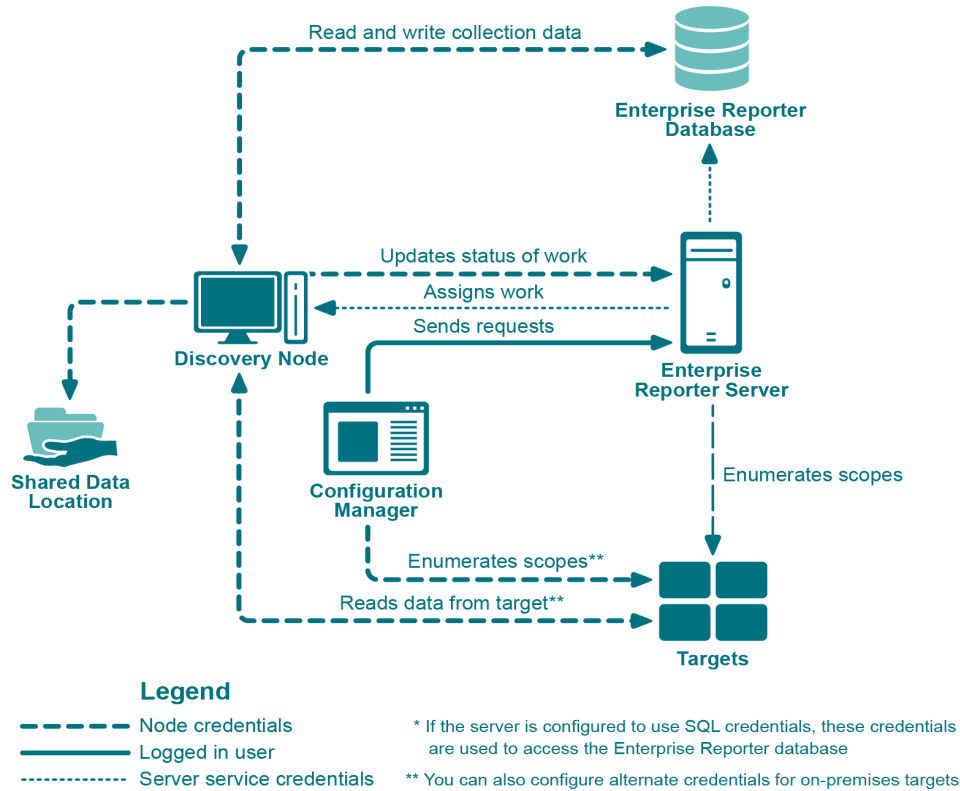

See also:

- [Node Credential and Alternate Credential Details for On-Premises Discoveries](#)
- [Detailed Permissions for Enterprise Reporter Discoveries](#)
- [Permissions for Enterprise Reporter Discoveries on NAS Devices](#)
- [Permissions for Enterprise Reporter Tenant Applications](#)

## Node Credential and Alternate Credential Details for On-Premises Discoveries

Node credentials are provided when a discovery node is created, and you can modify them as needed. By default, the node's credentials are used to enumerate scopes and access on-premises targets.

If you want to use different credentials for a particular discovery, you can configure them in the Discovery Wizard. By using these alternate credentials, you can target anything on-premises for which you have credentials, in any domain. You can minimize the permissions given to node credentials, and use alternate credentials for scoping and collecting your on-premises discoveries.



The following table outlines the use of the node and alternate credentials, and how to properly configure your environment to ensure successful data collection:

**Table 7. Node Credentials and Alternate Credentials in Configuration Manager**

<b>From</b>	<b>To</b>	<b>Permission Details</b>	<b>Configuration</b>
Discovery Node	Enterprise Reporter Server	Provide server with job status, errors, statistics and logs.	Configured during node creation, or when you edit the node properties to change the credentials.  The node credentials must have local administrator access to the host computer and be a member of the group "Reporter_Discovery_Nodes".
Discovery Node	Shared Data Location (if the cluster is configured to use one)	Read and write to the shared data location during data collection.	The shared data location is configured during the creation of a cluster. Ensure the node has read and write access to this file share. For more information, see the Things to Consider Before Creating a Cluster section in the Configuration Manager User Guide in the <a href="#">Technical Documentation</a> .

**Table 7. Node Credentials and Alternate Credentials in Configuration Manager**

<b>From</b>	<b>To</b>	<b>Permission Details</b>	<b>Configuration</b>
Discovery Node	Enterprise Reporter Database	<p>There are two options for communicating with the database:</p> <ol style="list-style-type: none"> <li>1. You can use the same service credentials that the node service uses.</li> <li>2. You can specify SQL credentials only for use when the database is accessed.</li> </ol> <p>The credentials you choose must be able to read and write to the database.</p>	<p>The account must be in the Reporter_Discovery_Nodes security group. (Note that if you use the same account as the Enterprise Reporter server it is already permissioned appropriately). For more information, see Role Based Security in Enterprise Reporter and Configuring the Database in the Quest Enterprise Reporter Installation and Deployment Guide <a href="#">in the Technical Documentation</a>.</p> <p>If you use SQL authentication to connect with the database, you must manually permission the SQL user, either by adding them to the database role Discovery_Nodes_Role or by permissioning specific tables in the database.</p>
Discovery Node	Targets	<p>Read access on all targets.</p> <p>For on-premises discoveries, all domains with which the credentials have a forest or domain level trust will be enumerated.</p> <p>If required, you can configure alternate credentials for specific discoveries, instead of using the default node credentials.</p>	<p>The targets are defined as part of a discovery. The discovery tasks are assigned to a particular node based on availability, so all nodes in a cluster should have access to all targets defined in all discoveries assigned to the node's cluster.</p> <p>For on-premises discoveries, ensure the node credentials or alternate credentials have read access to the target. In addition, a trust is required between the node computer and the targets.</p> <p>For more information on Azure and Office 365 Discoveries, see <a href="#">Detailed Permissions for Enterprise Reporter Discoveries</a> on page 19.</p>

# Detailed Permissions for Enterprise Reporter Discoveries

The following table outlines the permissions required for Enterprise Reporter discoveries.

**Table 8. Detailed Permissions required for Enterprise Reporter discoveries**

<b>Discovery Type</b>	<b>Permissions Required for Discovery Credential</b>
Active Directory	<p>An account with Active Directory read permissions is required to collect domain information, trusts, sites, domain controllers, and Active Directory computers, users, groups, and organizational units.</p> <p>The account being a member of the Built-in Domain Users group is sufficient to assign read permissions.</p>
Azure Active Directory	<p>An identity with read permission for the discovery target tenant. Read permissions are required for collection of tenant information, Azure Active Directory users, groups, group members, roles, and service principals.</p> <p>If additional credentials are being specified to minimize Azure throttling limitations, these credentials must have the same permissions as stated above.</p> <p>Also refer to credentials required to create and consent to the Enterprise Reporter Azure application required for this discovery. For more information, see <a href="#">Using the Tenant Application Manager</a> on page 47.</p>
Azure Resource	<p>An identity with read permissions for the discovery target tenant. Read permissions are required for collection of subscription, Resource groups, and resources.</p> <p>If additional credentials are being specified to minimize Azure throttling limitations, these credentials must have the same permissions as stated above.</p> <p>Also refer to credentials required to create and consent to the Enterprise Reporter Azure Resource application required for this discovery. For more information, see <a href="#">Using the Tenant Application Manager</a> on page 47.</p>
Computer	<p>An account with local administrator access on the scope computers to collect computer information, local groups and users, printers, services, policies, and event logs.</p>
Exchange	<p>To collect from Exchange targets, the credential account must have a mailbox on the target organization with access to read the permissions on the targets through EWS.</p> <p>To collect from Exchange 2007 targets, the credentials must be a member of the Exchange Organization Administrators Group.</p> <p>To collect from Exchange 2010, Exchange 2013, 2016, or Mixed Modes, the credentials must be a member of the Organization Management Group.</p> <p>To collect from Exchange 2016 or Exchange 2019, the credentials must have an administrator role with an assigned "ApplicationImpersonation" role.</p>
Exchange Online	<p>An account with access to the discovery target tenant.</p> <p>Read permission is required for collection of all Exchange Online information including mailboxes, mailbox delegates, public folders, mail-enabled users, mail contacts, distribution groups, group members, and permissions.</p> <p>If additional credentials are being specified to minimize Azure throttling limitations, these credentials must have the same permissions as stated above.</p>

**Table 8. Detailed Permissions required for Enterprise Reporter discoveries**

Discovery Type	Permissions Required for Discovery Credential
File Storage Analysis	<p>An account with local administrator access on the scoped computer is required to collect file, folder, share, and home drive analysis data.</p> <p>For permissions required when collecting NAS devices, see <a href="#">Permissions for Enterprise Reporter Discoveries on NAS Devices</a> on page 21.</p>
Microsoft SQL	<p>An account with local administrator access on the SQL Server is required. Additionally, the account must have read access to the scoped database to collect database information.</p>
Microsoft Teams	<p>An identity with read permissions for the discovery target tenant. Read permissions are required for collection of Microsoft Teams information including teams, members, channels, applications, and drives.</p> <p>If additional credentials are being specified to minimize Azure throttling limitations, these credentials must have the same permissions as stated above.</p> <p>Also refer to credentials required to create and consent to the Enterprise Reporter Microsoft Teams application required for this discovery. For more information, see <a href="#">Using the Tenant Application Manager</a> on page 47.</p>
NTFS	<p>If collecting through the administrator share, an account with local administrator access to the scoped computer is required.</p> <p>If collecting through a network share, an account with read permissions to the scoped shares is required.</p> <p>For permissions required when collecting NAS devices, see <a href="#">Permissions for Enterprise Reporter Discoveries on NAS Devices</a> on page 21.</p>
OneDrive	<p>An account with access to the discovery target tenant. Administrator permissions are required for collection of all drives including drive information, configuration settings, files, folders, and permissions. A SharePoint administrator role is recommended.</p> <p>Additionally, the discovery credentials must have site collection administrator rights to each drive that is being collected.</p> <p>If additional credentials are being specified to minimize Azure throttling limitations, these credentials must have the same permissions as stated above.</p> <p>Also refer to credentials required to create and consent to the Enterprise Reporter Azure application required for this discovery. For more information, see the Using the Tenant Application Manager section of the Configuration Manager User Guide in the <a href="#">Technical Documentation</a>.</p>
Registry	<p>An account with local administrator access to the scoped computer is required to collect registry information.</p>

# Permissions for Enterprise Reporter Discoveries on NAS Devices

The following table outlines the permissions required for Enterprise Reporter discoveries.

Table 9. Permissions required for Enterprise Reporter discoveries on NAS Devices

Discovery Type	Permissions Required for Discovery Credential
NetApp Cluster Mode	Multiple virtual machines belong to a single cluster. All of these virtual machines can be specified as discovery targets. These virtual machines must be part of a domain.  The NAS configuration must point to the cluster (name or IP address) with credentials that have read access to the cluster. These would typically be administrator credentials.
NetApp 7 Mode	In NetApp 7 mode, data can be collected on the storage controller or vFilers that are derived from the storage controller. Credentials with read access to the controller and vFiler are required.
NetApp Storage Controller	In NetApp 7 mode, data can be collected on the storage controller or vFilers that are derived from the storage controller. Credentials with read access to the controller and vFiler are required.
NetApp Filer	The vFiler can be a discovery target. In this case, the NAS configuration must point to the storage controller from which the vFilers are derived and the credentials must have read access to the storage controller.
Dell Fluid FS	The discovery target can be any Fluid FS VM. The NAS configuration must be the machine name or IP where Dell Enterprise Manager is installed and credentials must have access to Dell Enterprise Manager.
EMC Isilon	The discovery target can be any Isilon virtual machine. The NAS configuration must be the machine or IP that hosts the OneFS administration site and the credentials must have read access to it. By default, the connection is established using https and, if the connection is not deemed to be secure, the discovery will fail.

## Permissions for Enterprise Reporter Tenant Applications

Enterprise Reporter requires Azure applications for the collection of Azure and Office 365 objects and attributes. These applications must be registered in the Azure portal and consent must be granted for delegated permissions. To manage tenant applications used by Enterprise Reporter please refer to in the System | Configuration | Application Tenant Management section in the Enterprise Reporter Configuration Manager User Guide.

### OneDrive Azure Application Permissions

For the OneDrive discovery, an application with the name Quest Enterprise Reporter One Drive Discovery will be created. To create this application in your tenant, you must specify an account with administrative access to create applications. The account must have the Global Administrator role to be able to create and consent to the application.

Once created, the application must also be delegated permissions and an administrator must consent to the application's permissions using the Microsoft consent wizard. For the Quest Enterprise Reporter One Drive Discovery application, the following delegated permissions are required:

- Microsoft Graph: Read user files
- Office 365 SharePoint Online: Read user files

- Windows Azure Active Directory: Access the directory as signed-in user
- Windows Azure Active Directory: Read directory data

## Azure Active Directory Application Permissions

For the Azure Active Directory discovery, the Exchange Online discovery, and the collection of group members for the OneDrive discovery, an application with the name Quest Enterprise Reporter Azure Discovery will be created. To create this application in your tenant, you must specify an account with administrative access to create applications. The account must have the Global Administrator role to be able to create and consent to the application.

Once created, the application must also be delegated permissions and an administrator must consent to the application's permissions using the Microsoft consent wizard. For the Quest Enterprise Reporter Azure Discovery application, the following delegated permissions are required:

- Microsoft Graph: Access directory as the signed in user
- Microsoft Graph: Read all groups
- Microsoft Graph: Read all users' basic profiles
- Microsoft Graph: Read all users' full profiles
- Microsoft Graph: Read directory data
- Microsoft Graph: Read identity risky user information
- Microsoft Graph: Read your organization's security events
- Azure Active Directory Graph: Access the directory as signed-in user
- Azure Active Directory Graph: Read all groups

## Azure Resource Application Permissions

For the Azure Resource discovery, an application with the name Quest Enterprise Reporter Azure Resource Discovery will be created. To create this application in your tenant, you must specify an account with administrative access to create applications. The account must have the Global Administrator role to be able to create and consent to the application.

Once created, the application must also be delegated permissions and an administrator must consent to the application's permissions using the Microsoft consent wizard. For the Quest Enterprise Reporter Azure Resource Discovery application, the following delegated permissions are required:

- Windows Azure Service Management API: Access Azure Service Management as organization users
- Windows Azure Active Directory: Access the directory as signed-in user
- Windows Graph: Read all users' basic profiles

## Microsoft Teams Application Permissions

For the Microsoft Teams discovery, an application with the name Quest Enterprise Reporter Microsoft Teams Discovery will be created. To create this application in your tenant, you must specify an account with administrative access to create applications. The account must have the Global Administrator role to be able to create and consent to the application.

Once created, the application must also be delegated permissions and an administrator must consent to the application's permissions using the Microsoft consent wizard. For the Quest Enterprise Reporter Microsoft Teams Discovery application, the following delegated permissions are required:

- Microsoft Graph: Read all users' basic profiles
- Windows Azure Active Directory: Access the directory as signed-in user
- Windows Azure Active Directory: Read all groups

# Minimum Permissions for Initially Installing Enterprise Reporter

During your first installation, when you install the Enterprise Reporter server, there are two sets of credentials that you need to supply, as well as optional SQL credentials. This table outlines what the credentials are used for, and what permissions they require.

**Table 10. Credential Use and Required Permissions**

<b>Credentials</b>	<b>Used For</b>	<b>Permissions Needed</b>
Logged in user	Installing the components of Enterprise Reporter	Administrator access on the local computer.
	Creating the Enterprise Reporter database, roles and logins on the SQL Server® (unless SQL credentials are provided)	Must have the right to create databases, logins and groups.
	Creating the security groups	Depends on the type of groups that are chosen, but must have the right to create groups in the chosen environment.
	Securing the Configuration Manager and the Report Manager. The logged in user is added to the Reporter_Discovery_Admins, Reporter_Reporting_Admins, Reporter_Reporting_Operators, and Reporter_Discovery_Nodes security groups as an administrator for both consoles when installing the server.	
Service Account Supplied during installation	Installing and running the Enterprise Reporter server	Login as service right is conferred on the service account by the logged in credentials during installation.
	Connecting to the Enterprise Reporter database (unless SQL permissions are provided)	Read and write permissions are automatically granted during database creation.
	Securing the Configuration Manager and Report Manager. The service account is automatically added to the Reporter_Discovery_Admins, Reporter_Reporting_Admins, Reporter_Reporting_Operators, and Reporter_Discovery_Nodes security groups when installing the server.	
Optional SQL credentials Supplied during installation	Can be used to create the Enterprise Reporter database	Must have the right to create databases, logins and groups.
	If supplied, are used to connect the database by the Enterprise Reporter server.	Read and write permissions are automatically granted during database creation.

## Port Requirements

For the Enterprise Reporter components to communicate, some ports must be open.

- The default port used for communication between the server and the consoles is 7738. This port is also used by the nodes to access the server. The port is configured during installation of the server, and is required in the connection dialog box for both the Configuration Manager and the Report Manager.

You can view the port currently in use on the System | Information page in the Configuration Manager, and the System Information tab in the Report Manager.

- The default port used for communication from the Enterprise Reporter server to the nodes is port 7737. This port may be configured during installation.

This figure outlines the ports used by the Enterprise Reporter components.

Figure 3. Ports used by Enterprise Reporter components.

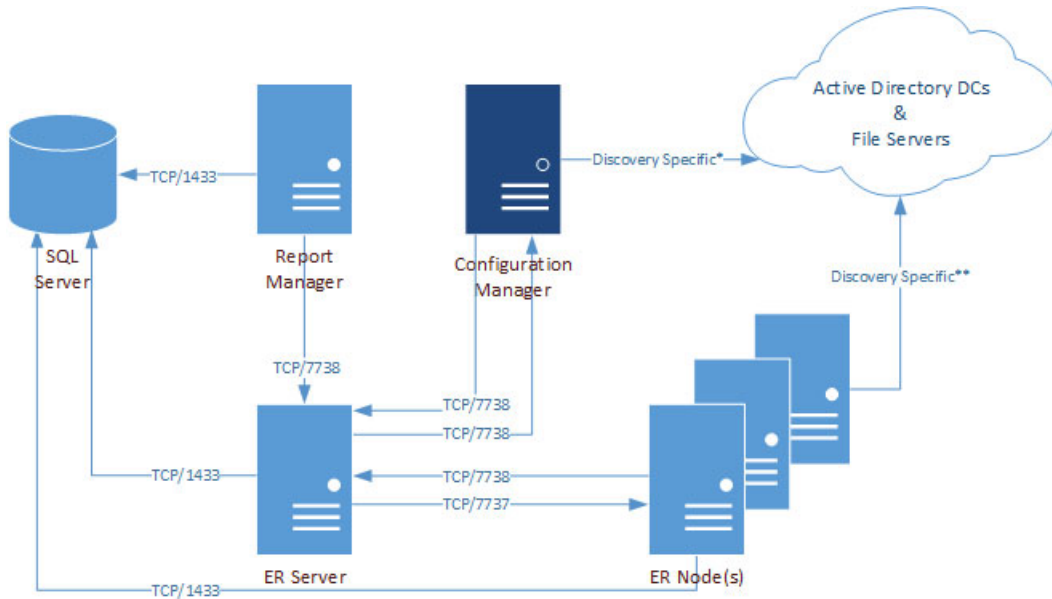

\*For more information on ports used when creating a discovery, see Table 11.

\*\*For more information on ports used during data collections, see Table 12.

This table outlines the ports used by all of the Enterprise Reporter components.

Table 11. Ports used by Enterprise Reporter components

Application	Port	Type	Configuration Manager <sup>a</sup>	Report Manager	SQL Server	ER Server	ER Nodes
FTP	20, 21	TCP		X			
SMTP	25	TCP	X	X		X	
WINS / NetBIOS Name Resolution	42	TCP UDP				X	
DNS FQDN Resolution	53	TCP UDP	X	X		X	X



Table 11. Ports used by Enterprise Reporter components

Application	Port	Type	Configuration Manager <sup>a</sup>				
			Report Manager	SQL Server	ER Server	ER Nodes	Components
Kerberos	88	TCP UDP	X				X
RPC Service & Endpoint Mapper / WMI	135	TCP UDP	X				
NetBIOS Name Service	137	UDP					X
NetBIOS Datagram (browsing)	138	UDP	X				
LDAP	389	TCP UDP	X				
SQL	1433	TCP		X	X	X	X
SQL Server Browser Service	1434	TCP UDP	X	X			
Enterprise Reporter Node	7737	TCP				X	X
Enterprise Reporter Server	7738	TCP	X	X		X	X

a. For the Configuration Manager, also include the ports listed in [Table 12](#).

This table outlines the ports used by all of the Enterprise Reporter discoveries.

Table 12. Ports used by Enterprise Reporter discoveries

Application	Port	Type	Discoveries										
			Active Directory	Azure Active Directory	Azure Resource	Computer	Exchange	Exchange Online	File Storage Analysis	NTFS	OneDrive	Registry	SQL Server
WINS / NetBIOS Name Resolution	42	TCP UDP	X			X	X		X	X		X	X
DNS FQDN Resolution	53	TCP UDP	X			X	X		X	X		X	X
HTTP	80	TCP		X	X		X*	X			X		X
Kerberos	88	TCP UDP	X			X	X*		X	X		X	X
RPC Service & Endpoint Mapper / WMI	135	TCP UDP				X	X**		X	X		X	X
NetBIOS Name Service	137	UDP	X			X	X		X	X		X	X
Remote Registry	139	TCP				X	X		X	X		X	
ICMP						X			X	X		X	X
LDAP	389	TCP UDP	X			X	X		X	X		X	X
HTTPS	443	TCP UDP		X	X						X		X
SMB / Remote Registry	445	TCP	X			X			X	X		X	X
LDAP Secure	636	TCP	X										
DCOM on XP/2003 and below (uses an open port in this range)	1024 - 5000	TCP UDP				X	X		X	X			X
SQL	1433	TCP	X	X	X	X	X	X	X	X	X	X	X
SQL Server Browser Service	1434	UDP											X
LDAP GC	3268	TCP	X				X						
WinRM	5985 5986	TCP UDP						X					X
Exchange PowerShell	12067	TCP					X**						
DCOM on Vista/2008 and above (uses an open port in this range)	49152 - 65535	TCP UDP				X	X		X	X			X

\*Exchange 2010 and higher, \*\*Exchange 2007 only

The following figures outline the ports used by the Enterprise Reporter discoveries.

Figure 4. Ports used by Active Directory collections

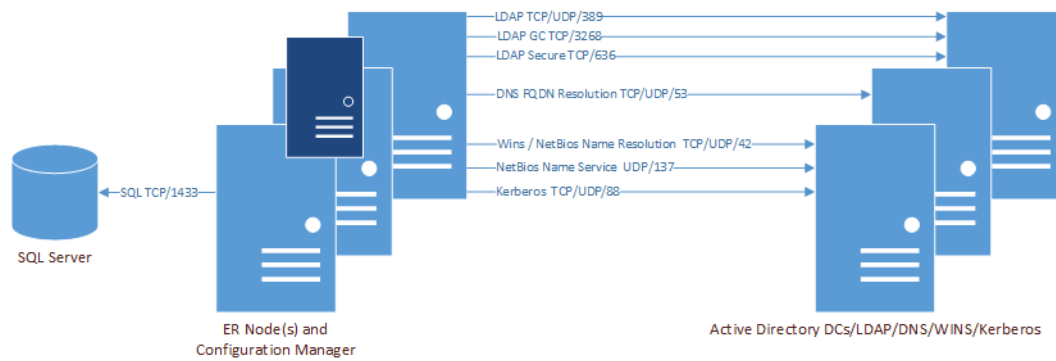

Figure 5. Ports used by Azure and Office 365 collections (Exchange Online, MS Teams, and OneDrive)

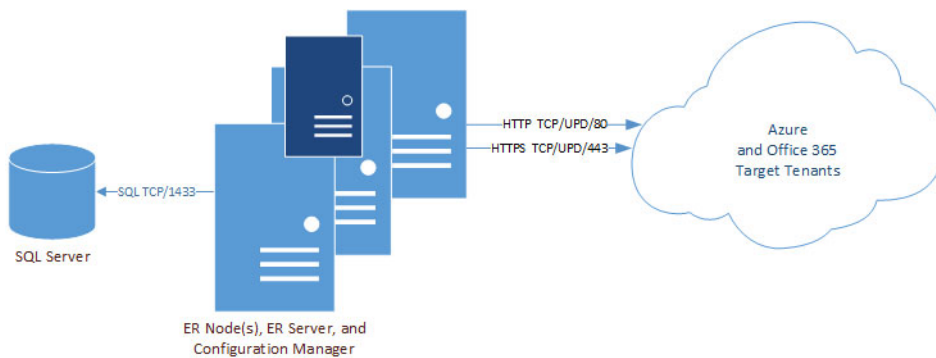

Figure 6. Ports used by Computer collections

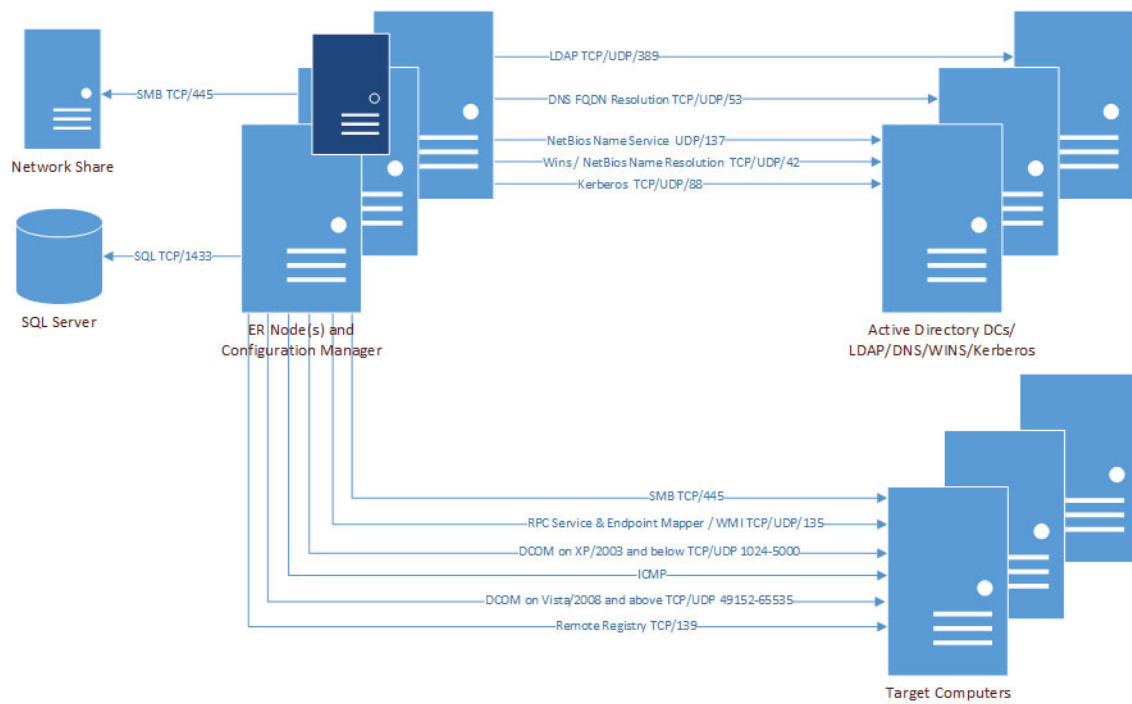

Figure 7. Ports used by Exchange collections

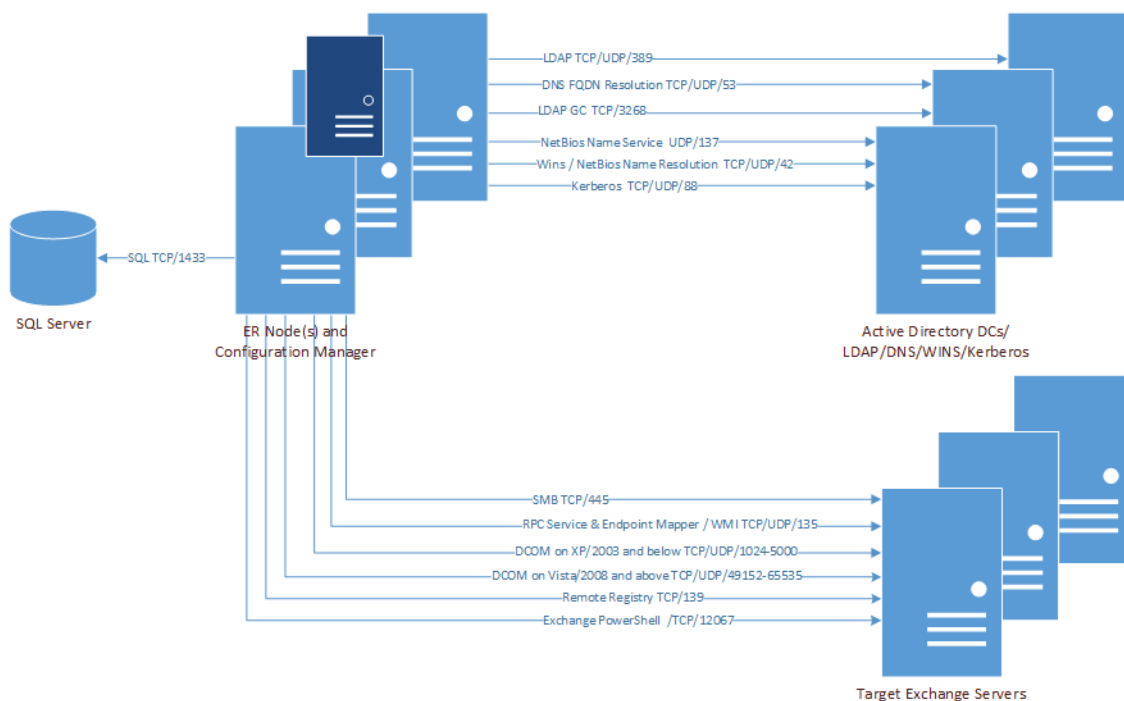

Figure 8. Ports used by File Storage Analysis collections

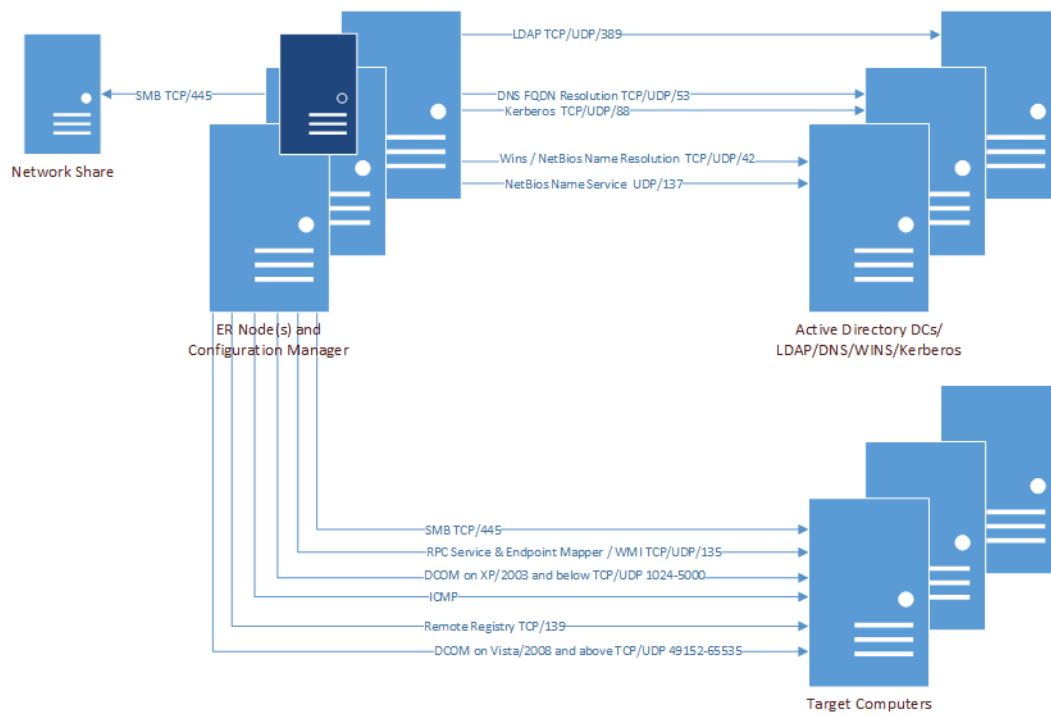

Figure 9. Ports used by NTFS collections

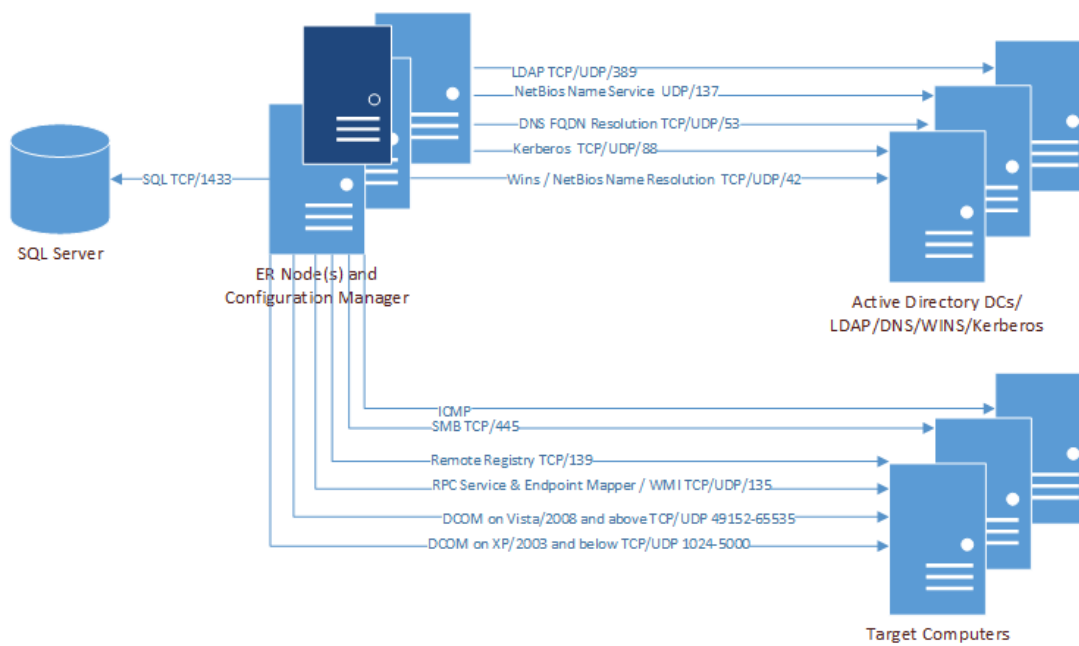

Figure 10. Ports used by Registry collections

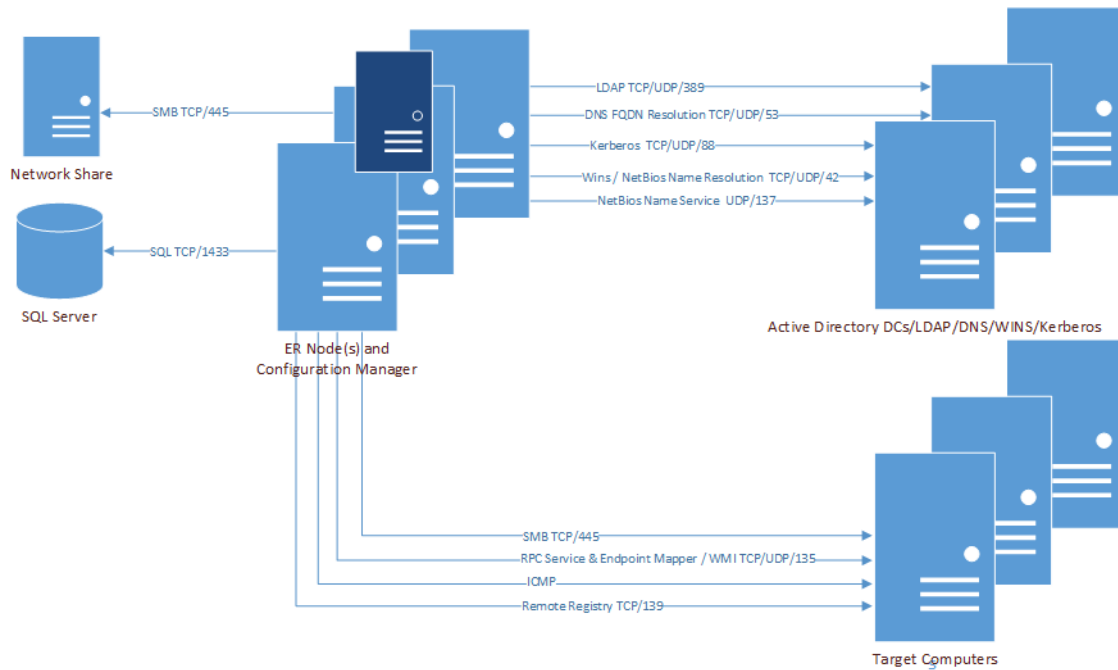
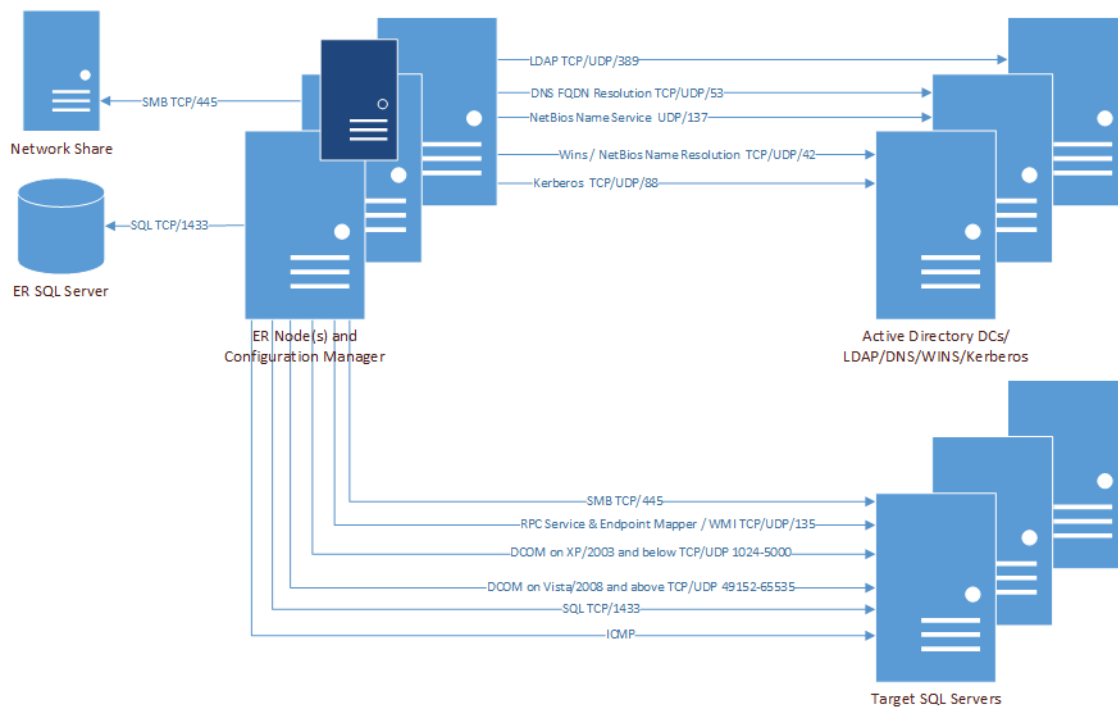

Figure 11. Ports used by SQL collections



# Installing Enterprise Reporter

Once you have ensured that your computers meet the system requirements, you can install the Enterprise Reporter server and consoles, and set up the Enterprise Reporter database. For full information on installing Enterprise Reporter, see *Installing and Configuring Enterprise Reporter* in the Quest Enterprise Reporter Configuration Manager User Guide in the [Technical Documentation](#).

## To install Enterprise Reporter components

- 1 Open the Autorun.

You can access all product documentation on the Documentation tab of the Autorun. You can also use the Autorun to set up the Knowledge Portal and IT Security Search.

- 2 On the Home page, click the **Enterprise Reporter Setup** tab.
- 3 Click **Open** next to the edition of **Quest Enterprise Reporter** for your operating system (64 bit).
- 4 On the Welcome screen of the Setup Wizard, click **Next**.
- 5 Click **View License Agreement** and scroll to review the entire license agreement.  
Optionally, click **Print** to send a copy of the agreement to the printer.
- 6 Select **I accept these terms to accept the agreement**, click **OK** to close the agreement, and click **Next** to continue the installation.

- OR -

Select **I do not accept these terms to reject the agreement**, click **OK** to close the agreement, and click **Cancel** to exit the installation.

- 7 To install all components, click **Next**.

- OR -

To install individual components, click the drive icon for each component, select the desired option, and click **Next**.

Clicking **Reset** restores the default setting of installing all components.

- 8 If you select the Reporter Server component without the Database Wizard component, a warning that the Database Wizard will be installed automatically is displayed. Click **Next** to continue.
- 9 If you are installing the Enterprise Reporter server, specify the credentials that will be used by the Enterprise Reporter server service, and click **Next**.

This service account must be able to access the SQL Server<sup>®</sup> where the Enterprise Reporter database resides.

- 10 If you are installing the Enterprise Reporter server, verify the default port of 7738 to be used for the Enterprise Reporter server, and click **Next**.

- OR -

If the default port 7738 is in use, specify an alternate port for the server, and click **Next**.

- 11 Click **Install**.

- 12 Click **Close**.

If errors were encountered during installation they are listed on this page.

- 13 If you have installed the server, you need to configure the database.

- OR -

If you have installed the Configuration Manager or Report Manager without the server, you must add the required user to the proper security group, or they will not be able to open the console.

For more information, see Role Based Security in Enterprise Reporter in the Quest Enterprise Reporter Installation and Deployment Guide in the [Technical Documentation](#).

## Create/Connect Your Enterprise Reporter Database

Next, you must create the Enterprise Reporter database. The Database Wizard appears automatically when you install the Enterprise Reporter server.

- 1 Choose **Create New Database**, and click **Next**.

- 2 Enter the target SQL Server® instance.

You can either type the instance name or browse to it. If you browse, you will see all SQL Servers® in your subnet that are configured to advertise their presence. If you do not see your server on the list, you must type the name.

- 3 Type a name for your database.

- OR -

Type the name of the existing empty database to be connected, or browse to it.

- 4 Select the preferred type of authentication to use to connect to the SQL Server®, and click **Next**.

Enterprise Reporter connects to the SQL Server® using Windows® authentication by default. If you want to connect using SQL credentials, enter them before clicking **Next**.

Enterprise Reporter validates the SQL Server® and your right to create a database on the instance before you can proceed to the next step.

- 5 If necessary, adjust the initial database size or file paths, and click **Next**.

Use the Database Estimator tool for further information based on the types of collections being performed.

- 6 If required, enter the domain of the Enterprise Reporter server's service account.

- 7 Enter the names for the security groups, and click **Next**.

Using the default group names is recommended.

For more information, see Security Groups in Enterprise Reporter in the Quest Enterprise Reporter Installation and Deployment Guide in the [Technical Documentation](#).

- 8 Review the message box, and click **OK** to continue.

- OR -

Click **Cancel** to further modify the Security Group Names.

- 9 Optionally, accept the default to open Configuration Manager.

Once the database is created, you will use the Configuration Manager to enter the Enterprise Reporter licences and configure the collection of network information.

- 10 Click **Finish** to create the database.

A task progress dialog will be displayed as the database is created.

- 11 When creation is complete and successful, a notice to backup the encryption key is displayed. Click **OK** to accept the message and start the Encryption Key Manager.

**i** | **IMPORTANT:** It is important to backup the encryption key. The Encryption Key Manager will automatically start on the Enterprise Reporter Server. Use the **Export Key** option to create a backup file of the encryption key. For more information, see [Appendix: Encryption Key Manager](#) on page 99.

- OR -



If errors were encountered during database creation, an error dialog box displays.

For help troubleshooting errors, see Database Configuration Issues in the Quest Enterprise Reporter Installation and Deployment Guide in the [Technical Documentation](#).

## Configure Enterprise Reporter Licenses

You need either a trial or full license to use Enterprise Reporter. You must have a valid license to use the Configuration Manager; no license is required for the Report Manager. If you have questions about your license, contact your sales representative.

See also:

- [Activating or Updating Your License](#)

**Table 13. Enterprise Reporter Licenses**

<b>Enterprise Reporter License</b>	<b>Discovery Types Available with License</b>	<b>Report Libraries Available with License</b>
Enterprise Reporter for Windows Servers	<ul style="list-style-type: none"> <li>• NTFS</li> <li>• Computer</li> <li>• Registry</li> <li>• OneDrive</li> <li>• Azure Resource</li> </ul>	<ul style="list-style-type: none"> <li>• NTFS</li> <li>• Computer</li> <li>• Registry</li> <li>• Office 365   OneDrive</li> <li>• Change History</li> <li>• Hybrid</li> <li>• Azure   Resources</li> </ul>
Enterprise Reporter for Active Directory	<ul style="list-style-type: none"> <li>• Active Directory</li> <li>• Azure Active Directory</li> </ul>	<ul style="list-style-type: none"> <li>• Active Directory</li> <li>• Azure</li> <li>• Change History</li> <li>• Hybrid</li> </ul>
Enterprise Reporter for SQL Server	<ul style="list-style-type: none"> <li>• MS SQL</li> </ul>	<ul style="list-style-type: none"> <li>• Microsoft SQL Server</li> <li>• Change History</li> </ul>
Enterprise Reporter for File Storage Analysis	<ul style="list-style-type: none"> <li>• File Storage Analysis</li> </ul>	<ul style="list-style-type: none"> <li>• File Storage Analysis</li> </ul>
Enterprise Reporter for Exchange	<ul style="list-style-type: none"> <li>• Exchange</li> <li>• Exchange Online</li> </ul>	<ul style="list-style-type: none"> <li>• Exchange</li> <li>• Office 365   Exchange Online</li> <li>• Hybrid</li> </ul>

Table 13. Enterprise Reporter Licenses

Enterprise Reporter License	Discovery Types Available with License	Report Libraries Available with License
Enterprise Reporter for Office 365	<ul style="list-style-type: none"> <li>Exchange Online</li> <li>Azure Active Directory</li> <li>Azure Resource</li> <li>OneDrive</li> <li>Microsoft Teams</li> </ul>	<ul style="list-style-type: none"> <li>Office 365   Exchange Online</li> <li>Azure</li> <li>Office 365   OneDrive</li> <li>Office 365   Microsoft Teams</li> </ul>
Enterprise Reporter Suite	<ul style="list-style-type: none"> <li>Active Directory</li> <li>Azure Active Directory</li> <li>Azure Resource</li> <li>Computer</li> <li>File Storage Analysis</li> <li>Exchange</li> <li>Exchange Online</li> <li>Microsoft Teams</li> <li>MS SQL</li> <li>NTFS</li> <li>OneDrive</li> <li>Registry</li> </ul>	<ul style="list-style-type: none"> <li>Active Directory</li> <li>Azure</li> <li>Change History</li> <li>Computer</li> <li>Exchange</li> <li>File Storage Analysis</li> <li>Hybrid</li> <li>Microsoft SQL Server</li> <li>NTFS</li> <li>Office 365   Exchange Online</li> <li>Office 365   Microsoft Teams</li> <li>Office 365   OneDrive</li> <li>Registry</li> <li>Security Explorer Remediation</li> </ul>

## Activating or Updating Your License

Activate or update your license in the Configuration Manager on the System | Information page.

### To activate your license

- 1 Install and open the Configuration Manager.
- 2 Connect to your Enterprise Reporter server.  
If no license has been installed, the licensing dialog box appears.
- 3 Click **Update License** and navigate to your license file.
- 4 Click **Open**.
- 5 In the licensing dialog box, click **OK**.

## Create Your First Enterprise Reporter Cluster and Node

The Configuration Manager contains a wizard that walks you through the process of creating clusters and nodes. You can create a cluster without a node, and add the nodes later, but you will not be able to run a discovery without an enabled node.

### To create your first cluster and node

- 1 On the Manage Discovery Clusters pane, click **Create Cluster**.
- 2 Enter a name for the cluster.

A default name, First Cluster, is provided, but you should change this to something meaningful, such as the location of your cluster.

- 3 Browse to your shared data location, and click **OK**.

- OR -

Select **No network share specified**.

For more information, see Things to Consider Before Creating a Cluster in the Quest Enterprise Reporter Configuration Manager User Guide in the [Technical Documentation](#).

If desired provide a description.

- 4 Click **Next**.

If you do not wish to add any nodes at this time, skip to step 11.

- 5 Browse to the computer where the node is to be created, and click **OK**.

- 6 Select an account from the Credential Manager.

If the account you want is not on the list, click **Add**, enter the account, and select it from the list.

**i** | **NOTE:** The node credentials must have local administrator access to the host computer and be a member of the Reporter\_Discovery\_Nodes group.

For more information, see Using the Credential Manager in the Quest Enterprise Reporter Configuration Manager User Guide in the [Technical Documentation](#).

To use SQL credentials to connect to the database, select **Database Credential**, choose **SQL Authentication**, and select the SQL account from the Credential Manager.

- 7 Optionally, set tasks to be System - managed or specify a Maximum number of tasks..

For more information, see Nodes in the Quest Enterprise Reporter Configuration Manager User Guide in the [Technical Documentation](#).

Click **Add**.

You can add more than one node at a time to the same cluster. Repeat steps 6 through 9 until you have added all of your nodes.

By default, nodes are enabled after they are created. If you prefer to manually enable the nodes, clear the Enable Node check box. At least one node must be enabled in order for your cluster to be functional.

- 8 Click **Finish**.

If you chose to create a cluster without any nodes, click Yes.

The new node appears on the Discovery Nodes tab. Your node will be enabled, unless you cleared the Enable the nodes check box.

For a listing of possible node statuses, see What does the status of a node or cluster indicate? in the Quest Enterprise Reporter Configuration Manager User Guide in the [Technical Documentation](#).

**i** | **NOTE:** When a node is deployed and enabled, the cluster is also enabled. If you deployed the node without enabling it, you have to manually enable the cluster.

For more information, see Enabling a Cluster in the Quest Enterprise Reporter Configuration Manager User Guide in the [Technical Documentation](#).

# Step-By-Step Walkthroughs

Enterprise Reporter is a very flexible reporting tool, that can be used for many different purposes. This section uses examples of common uses to highlight how to set up Enterprise Reporter to maximize its potential.

- [Pre- and Post-Migration Assessment](#) — Assess your network environment before migrating to identify any issues, and re-assess once the migration is complete to ensure that everything went as planned.
- [Manage Compliance](#) — Set up reports to automatically generate and be delivered, minimizing the time you have to spend demonstrating compliance.
- [Change History Reporting](#) — Track changes in your network environment using Change History Reporting. You can monitor changes to hardware, SQL databases, files, folders and so on.
- [File Storage Consolidation](#) — Prepare for storage migration by identifying and excluding from migration files that are unused, orphaned, or are in violation of your storage usage policy.
- [Office 365 and Azure Reporting](#) - Assess your Office 365 and Azure usage and configuration.

This walkthrough will guide you through each of these use cases for Enterprise Reporter. Each scenario shows you how to leverage Enterprise Reporter to get the information you want when you need it.

**i** | **NOTE:** These scenarios assume you have installed Enterprise Reporter and set up the database. For more information, see [Installing Enterprise Reporter](#) on page 31.

## Pre- and Post-Migration Assessment

Before you migrate computers and users to a new environment, you should assess their current state. Using reports generated by Enterprise Reporter, you can ensure that everything is ready to be migrated. Once the migration is complete, you can re-assess to ensure your environment is as you expect, and identify any issues that need resolving.

### Scenario

You have received a request to identify all users, groups, and group memberships for a particular domain, and to provide it in Excel format for tracking purposes. This same report will be required after migrating all users to a new domain.

You will need to take the following steps:

- 1 [Configure a Cluster to Perform the Data Discovery](#)
- 2 [Create a Discovery to Define the Data Collection](#)
- 3 [Run the Discovery to Collect the Data](#)
- 4 [Run the Reports You Need and Export Them to Excel](#)

## Configure a Cluster to Perform the Data Discovery

You must configure at least one cluster. A cluster is a logical collection of one or more computers (nodes) on which discoveries are executed. A discovery must be assigned to a cluster. A cluster can access an optional shared data location for discovery data. This reduces network traffic, and the processing load on the server.

**i** | **TIP:** In order to reduce network traffic and avoid delays in communication, a cluster should serve a single geographic location.

Clusters are created in the Configuration Manager. To ensure you have the necessary access to the consoles and reports, make sure you are still logged in to your computer with the same user account that you used to install Enterprise Reporter.

If you do not have the Configuration Manager open, perform the following steps:

### **To connect to a server**

1 Click the **Start** menu and select **Quest | Configuration Manager**.

2 Type the name of the server.

- OR -

Click **Browse**, and locate the computer where the server is installed.

Once you have connected to a server, the server name is stored in the list for future use.

3 If necessary, type in the port number.

4 Click **Log In**.

The Create Cluster wizard walks you through the process of setting up a cluster. If you want to create a new Cluster, see [To create your first cluster and node](#) on page 35.

## **Create a Discovery to Define the Data Collection**

Once you have configured a cluster, you can begin setting up discoveries. Discoveries define the targets from which you will be collecting data. Enterprise Reporter uses a "collect all" model. After you run a discovery, you can run reports that include the data you have collected.

In this scenario, you need to collect all users, groups, and group memberships for a particular domain, therefore you need to create an Active Directory® discovery. You will assign the discovery to the cluster you just created.

### **To create an Active Directory discovery**

1 On the Manage Discoveries page of the Configuration Manager, select **New Discovery | Active Directory**.

2 On the name page, enter **AD - [Domain Name]** so you can identify the discovery easily once you have a list of discoveries.

3 Since you only have one cluster, it is automatically selected, and you can click **Next**.

4 On the Scopes page, click **Add** to choose your domain.

5 Browse to the domain for which you want to collect data, click **Include**, and click **OK** to close the Browse dialog box.

If you only wanted to know about a specific OU, you can drill into the domain and select it. The parent domain is automatically included, but only the OU will be collected.

6 To shorten collection time, you can select only the options you want to collect. Clear the following options: **Computers, Domain Controllers, Permissions, Trusts, Sites, Deleted Objects, and Active Roles Virtual Attributes**.

7 For the **Users** option and the **Groups and Members** option, select the main heading and clear all sub-options.

By carefully considering the data your reporting users require, you can ensure that collection time is minimized.

8 Click **Next**.

9 Since we want to run this discovery right away, no schedule is necessary and you can click **Finish**.

## **Run the Discovery to Collect the Data**

You can schedule discoveries or run them on demand. In this case, we want to collect this data right away. Each discovery is broken down into tasks, which are assigned to the node for processing. If you have more than one node, Enterprise Reporter uses load balancing to ensure the most efficient processing. You can track the progress of your discovery.

### **To run a discovery**

- 1 On the Manage Discoveries page, select the discovery **AD - [Domain Name]**.
- 2 Click **Run**.
- 3 To view the progress of the discovery, click the **Processing** link in the Next Run column.

When the discovery is complete, the status in the Last Run Status column will change. If there were any errors during collection, click the status to view the details of the last run.

## **Run the Reports You Need and Export Them to Excel**

Once data is collected, you can run reports against it. When you run a report, it returns data based on the most recent data collected by the discoveries, the selected fields, and any parameter values you enter. Some reports may have required parameters; in this case, the report will not run unless you enter valid parameter values.

To produce the requested information, you must run three reports that are included in Enterprise Reporter:

- Domain Groups — shows all the groups in the domain.
- Domain Groups and Members — shows the members of all groups in the selected domain.
- Domain Users — shows all the users in the domain

Once you have run a report, you can export it to the Excel format.

### **To run each report**

- 1 Open the Report Manager by selecting **Start | Quest | Report Manager**.
- 2 In the connection dialog box, enter the name of the computer where the server is hosted and click **Connect**.
- 3 On the Report tab, expand **Report Library | Active Directory** and select your first report, for example Domain Groups.
- 4 In the **Include the following domains** parameter, type the domain name, and click **Add**.  
You also can click **Search**, locate and add the domain, and click **OK**.
- 5 Click **Run Report**.  
The report appears in a new window. Depending on the amount of data, it may take a few minutes to generate.
- 6 On the tool bar, click the **Export Document** drop-down arrow, and choose **XLS** (older versions of Excel or XLSX (Excel 2007 and later)).
- 7 In the Export Options dialog box, click **OK**.
- 8 In the Save As dialog box, select a location for the report, and change the name if desired.
- 9 Click **Save**.
- 10 Click **Yes** to view the report in Excel.

You can now use the spreadsheet as needed to perform pre- and post-migration analysis.

You can repeat this process for the other two reports. Once you have completed the migration, you can create a new discovery to run against the new domain, and ensure that the migration was successful.

## **Manage Compliance**

If you are required to regularly show compliance with corporate or regulatory security requirements, Enterprise Reporter can be of great assistance by automatically gathering information and reporting on it.

## Scenario

At the beginning of each month, you must deliver a report that shows that users who have been inactive for three months have their accounts disabled, in line with your corporate security policy. You are going to use two reports to do this: one report for yourself, in order to identify accounts that are not compliant, and one report that is sent to the stakeholders showing compliance. You will automate the delivery of the monthly report, to ensure it is always on time. You will need to take the following steps:

- 1 [Modify an Existing Report](#)
- 2 [Schedule the Discovery](#)
- 3 [Schedule Report Delivery to Stakeholders](#)

## Modify an Existing Report

You need to modify an existing report to only show accounts that have been inactive for 90 days and are not disabled. You should manually run an appropriate Active Directory® discovery right before you run the report to ensure you are getting up to date data. This will allow you to address any issues before your compliance report is sent out. To do this, you must perform the following steps:

- 1 Copy the report from the Library to My Reports, which is the only container in which you can edit reports.
- 2 Edit the report to remove unnecessary fields from the report, and to create a hidden parameter to filter disabled accounts.
- 3 Modify the report layout to remove unnecessary fields.
- 4 Run the report to identify issues.

### ***To copy the report so you can edit it***

- 1 On the Report tab of the Report Manager, expand **Report Library | Active Directory**.
- 2 Locate the **Domain Users without Recent Logons** report, and drag it into the **My Reports** container.

### ***To edit the report name, fields, and parameters***

- 1 In the My Report container, select the **Domain Users without Recent Logons** report, and click **Edit Report**.
- 2 Change the report name to **Domain Users to be Disabled**.
- 3 Change the report description to **Shows users in the selected domains who have not logged on in the past 90 days and whose accounts are still enabled**.
- 4 Select the **Fields** tab.
- 5 In the Selected Fields list, select **Is Locked** and **Number of Logons**, and click **Remove**.  
A warning dialog box appears, indicating that the report layout needs to be updated. Click **Yes**.  
You could skip this step, however your report will be more usable if it contains only the required information.
- 6 Select the **Parameters** tab.
- 7 Click **+Create**.
- 8 Set the Usage to **Hidden**.
- 9 Set the associated field to **IsDisabled**.
- 10 Set the operator to **Equals** and the value to **No**.
- 11 Click **OK**.

Leave the dialog box open so you can modify the layout.

### To modify the report layout

- 1 In the Edit Report dialog box, click the **Layout** tab.  
It may take a few seconds for the layout to generate.
- 2 Click **Edit**.
- 3 To change the report title, double-click in the text box containing the current title, and replace the text with **Domain Users to be Disabled**.
- 4 In the detailHeader row of the report layout, right-click **Number of Logons**, and select **Delete**.
- 5 Repeat for **IsDisabled** and **IsLocked**.
- 6 In the detailBand row of the report layout, remove all fields except **Account Name** and **Last Logon (Domain User)**.
- 7 Check your report layout to ensure it is accurate:

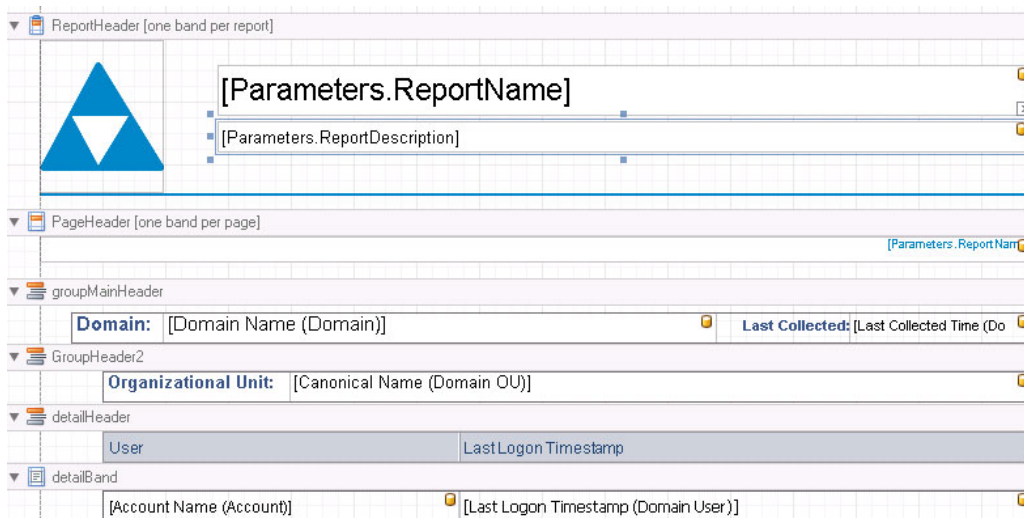

- 8 Click **OK** to close the Edit Report dialog box.
- 9 Click **OK** to close the Edit Report Definition dialog box, and finish editing the report.

### To run the report and save the parameter values for future report runs

- 1 If necessary, in the My Reports container, select the **Domain Users to be Disabled** report.
- 2 In the **Include the following domains** parameter, type the domain name, and click **Add**.  
You can also click **Search**, locate and add the domain, and click **OK**.
- 3 In the **Users not logged on in the last (days)** parameter, change the number of days to **90**.
- 4 To make these the default parameter values, click **Save parameters as default**, and click **OK** in the confirmation dialog box.
- 5 Click **Run report**.

Your report appears, listing all users who are not in compliance. You can now make any changes you need prior to the sending the compliance report to your stakeholders.

## Schedule the Discovery

In this scenario, the Active Directory® collection previously configured collects the necessary data. We will edit it to run on a scheduled basis, so that the scheduled reports have up-to-date data. You can also run it manually before you run the report you modified that identifies any compliance issues.



### ***To edit a discovery and create a schedule***

- 1 On the Manage Discoveries page of the Configuration Manager, select the **AD - [Domain Name]** discovery you created, and click **Edit**.

- OR -

If you did not create an Active Directory® discovery that collects accounts, follow the steps in [Create a Discovery to Define the Data Collection](#) on page 37, but stop on the Schedule page.

- 2 If necessary, click the **Schedule** tab.
- 3 Click **Monthly**, and select the last Friday of the month.
- 4 Click **+Add**.
- 5 Click **OK** if you edited an existing discovery.

- OR -

Click **Finish** if you created a new discovery.

## **Schedule Report Delivery to Stakeholders**

Once the data has been collected, the reports can be generated. Using the Schedule tab of the Report Manager, you can create a schedule that will automatically deliver the desired reports to your specified recipients.

To do this, you must:

- 1 Copy the Domain Users without Recent Logons report to My Reports, the only container from which you can schedule a report.
- 2 Create a report schedule.
- 3 Configure your SMTP server.
- 4 Schedule the report, and provide parameter values.

### ***To copy the report so you can schedule it***

- 1 On the Report tab of the Report Manager, expand **Report Library | Active Directory**.
- 2 Locate the **Domain Users without Recent Logons** report, and drag it into the **My Reports** container.

If you did not rename the report when you modified an existing report (see [Modify an Existing Report](#)), the report will have a (1) after its name so you can differentiate them.

### ***To create a report schedule***

- 1 In the Report Manager, click the **Schedule** tab.
- 2 Click **+New Schedule**.
- 3 Name the schedule **Compliance Reports**.
- 4 Click **Monthly**, and select day **1** of the month.
- 5 Launch the Credential Manager, and add an account that has read access to the database.
- 6 In the Delivery section, choose a network share where the reports will be delivered.  
Ensure the credentials provided in the previous step have write access to this share.  
Leave the dialog box open to configure email delivery.

### ***To configure email delivery***

- 1 In the Delivery section of the Create or Edit Schedule dialog box, enable the **Send Email** option.
- 2 Click **Configure mail server**, and enter the server name and port number.
- 3 Launch the Credential Manager, and select the account used to access the mail server.

If your SMTP server is configured to accept anonymous connections, you do not need to provide an account.

You can test your connection to ensure the mail server is properly configured.

- 4 In the From field, type the email address of the sender.
- 5 In the To field, type the email addresses of the recipients, separated by a comma or semicolon.
- 6 Click **OK**.

The schedule card is created.

### **To schedule a report**

- 1 On the Compliance Reports schedule card, click **+Schedule Report**.
- 2 Select **Domain Users without Recent Logons**, and click **OK**.
- 3 In the Parameters pane, in the Description text box, type **[Domain Name] Users not logged in for 90 days** to identify the parameter values you will use.
- 4 In the **Include the following domains** parameter, type the domain name, and click **Add**.  
You can also click **Search**, locate and add the domain, and click **OK**.
- 5 In the **Users not logged on in the last (days)** parameter, change the number of days to **90**.
- 6 Click **Save**.

Your report will now run automatically, reporting on the data from your scheduled discovery.

## Change History Reporting

Enterprise Reporter can help you quickly identify changes that have occurred in your environment. If you enable change history, a record of all changes over time is kept. You can then report on these changes, and ensure that required changes have been made, or investigate unwanted changes. You can track changes to:

- Group membership
- Active Directory® domains
- Computers
- NTFS files, folders or shares
- Registry keys or values
- SQL servers or databases

## Scenario

As part of your job, you are responsible for monitoring changes to critical services. Once a week, you must generate a report to ensure only expected changes are being made. Since collecting change history involves more data, you want to scale up your cluster to handle the increased traffic.

You will need to take the following steps:

- [Add Another Node to a Cluster](#)
- [Enable Change History for the Computer Discovery Type](#)
- [Create and Schedule a Discovery](#)
- [Schedule the Report](#)

## Add Another Node to a Cluster

Each target is assigned to a node, balancing the distribution across the nodes until all the nodes are processing as many tasks as they are able. If no nodes are available to process the task, it must wait until a node becomes available.

When you run a computer discovery, each computer in the discovery is separate task that can be assigned to a node. In this case, adding nodes will speed up the performance of your discovery. This is particularly important as we are collecting change history data as well, which will increase the time taken to process each task.

In this scenario, you are going to add another node to handle collecting more data from a larger number of targets.

### **To create a node**

- 1 On the Manage Discovery Clusters pane, select the cluster you created.
- 2 In the bottom pane, on the Discovery Nodes tab, click **Add Node**.
- 3 Browse to the computer where the node is to be created, and click **OK**.
- 4 Select the service account from the Credential Manager.

If you want to use a different account, you can add it to the Credential Manager.

- 5 Click **Add**.

All other configuration is optional.

## Enable Change History for the Computer Discovery Type

You configure change history at a global level for each discovery. All discoveries of that type will collect this data. When you create a discovery, the Name page indicates whether change history is enabled for the discovery type.

In this scenario, it is important to enable change history before running the first discovery, so that all changes are captured.

### **To enable history for a computer discovery**

- 1 On the Discovery Management | Configuration page, click **Configure global change history settings**.  
A button shows the current status of the change history configuration for each discovery type.
- 2 For the Computer discovery type, click **Disabled** to toggle the setting.  
The button changes to Enabled, indicating that Change History data will be collected.
- 3 Click **Close**.

## Create and Schedule a Discovery

Since you need this weekly, you can create a weekly discovery. In this simple case, we are assuming that the targeted computers are located relatively close together. If they were very dispersed, you would create different discoveries in the appropriate cluster to ensure faster collections. Each computer should only be in one discovery, so while we are going to configure the discovery to collect the minimal needed data, if at a later time more information is needed, this discovery should be expanded, rather than creating a new one to gather the new data.

### **To create and schedule a computer discovery**

- 1 On the Manage Discoveries page of the Configuration Manager, select **New Discovery | Computer**.
- 2 On the name page, enter **Computer Services** so you can identify the discovery easily once you have a list of discoveries.
- 3 Since you only have one cluster, it is automatically selected, and you can click **Next**.
- 4 On the Scopes page, click **Add** to choose your computers.  
Browse to locate the computers, click **Include**, and click **OK** to close the Browse dialog box.

- OR -

On the Scopes page, click **Import** to add computers from a file. Browse to locate the file containing the computers to add, select the file, click **Open** to start the import, review the import results, and click **OK** to close the results screen. For more information, see the Importing Computers to Your Scopes section of the Quest Enterprise Reporter Configuration Manager User Guide in the [Technical Documentation](#).

- 5 To shorten collection time, you can select only the options you want to collect. Click **Deselect All** and then select the **Services** check box.

Remember that if you later decide to collect more information from the targeted computers, you should edit this discovery, not create a new one.

- 6 Click **Next**.
- 7 Click **Weekly** and schedule the discovery to run once a week.
- 8 Click **Finish**.

## Schedule the Report

When you are scheduling a report with time-sensitive information in it, you must make sure the discovery has time to finish collecting all of its data before you run the report. For small, simple discoveries, this should be easy to predict, but for large discoveries, or discoveries that are slowed down by network issues, such as nodes placed far from their targets or connectivity problems, it may take a few runs to learn how long it will take.

For more details on the steps to take to schedule a report, see [Schedule Report Delivery to Stakeholders](#) on page 41.

### ***To copy the report so you can schedule it***

- 1 On the Report tab of the Report Manager, expand **Report Library | Change History** and drag the Computer Change History report to **My Reports**.
- 2 On the Schedule tab, click **+New Schedule**, and enter **Service Changes** as the schedule name.
- 3 Create a weekly schedule for a time after the discovery will complete.
- 4 Launch the Credential Manager, and add an account that has read access to the database.
- 5 In the Delivery section, choose a network share where the reports will be delivered.  
Ensure the credentials provided in the previous step have write access to this share.
- 6 In the From field, type the email address of the sender.  
This assumes that the mail server delivery has already been set up as outlined in [Schedule Report Delivery to Stakeholders](#) on page 41.
- 7 In the To field, type the email addresses of the recipients, separated by a comma or semicolon.
- 8 Click **OK**.  
The schedule card is created.

### ***To add the report***

- 1 On the Service Changes schedule card, click **+Schedule Report**.
- 2 Select **Computer Change History**, and click **OK**.
- 3 In the Parameters pane, in the Description text box, type **Changed services on [computer names]** to identify the parameter values you will use.
- 4 In the **Include the following domains** parameter, type the domain name, and click **Add**.  
You also can click **Search**, locate and add the domain, and click **OK**.
- 5 In the **Include the following computers** parameter, click **Search**, and add the computers you targeted.

If you want to add all computers in the selected domains, you can use the \* wildcard, and click **Add** instead of searching for specific computers.

- 6 In the **Include the following changes** parameter, click **Search** and add **Services**.
- 7 Click **Save**.

Your report will now run automatically, reporting on the data from your scheduled discovery.

## File Storage Consolidation

Before you migrate computers to a new environment, you should assess their file storage. Using reports generated by Enterprise Reporter, you can ensure that only the required data is moved.

### Scenario

You have received a request to get ready for storage migration and consolidation by identifying (and excluding from migration) files that are duplicate, unused, orphaned or that violate storage usage policy.

You will need to take the following steps:

- 1 [Configure a Cluster to Perform the Data Discovery](#)
- 2 [Create Discoveries to Define the Data Collection](#)
- 3 [Run the Discoveries to Collect the Data](#)
- 4 [Run the Reports You Need](#)

## Configure a Cluster to Perform the Data Discovery

You must configure at least one cluster. A cluster is a logical collection of one or more computers (nodes) on which discoveries are executed. A discovery must be assigned to a cluster. A cluster can access an optional shared data location for discovery data. This reduces network traffic, and the processing load on the server.

**i** | **TIP:** In order to reduce network traffic and avoid delays in communication, a cluster should serve a single geographic location.

Clusters are created in the Configuration Manager. To ensure you have the necessary access to the consoles and reports, make sure you are still logged in to your computer with the same user account that you used to install Enterprise Reporter.

If you do not have the Configuration Manager open, perform the following steps:

### **To connect to a server**

- 1 Click the **Start** menu and select **Quest | Configuration Manager**.
- 2 Type the name of the server.  
- OR -  
Click **Browse**, and locate the computer where the server is installed.  
Once you have connected to a server, the server name is stored in the list for future use.
- 3 If necessary, type in the port number.
- 4 Click **Log In**.

The Create Cluster wizard walks you through the process of setting up a cluster. If you want to create a new Cluster, see [To create your first cluster and node](#) on page 35.

## Create Discoveries to Define the Data Collection

Once you have configured a cluster, you can begin setting up discoveries. Discoveries define the targets from which you will be collecting data. Enterprise Reporter uses a "collect all" model. After you run a discovery, you can run reports that include the data you have collected.

In this scenario, you need to collect information about the files and folders stored on particular servers and then analyze it. Since there is information you will need at the server level, the folder level, and the file level, and then you will analyze it, you need to create multiple discoveries targeting the same computers to collect each type of information.

- File Storage Analysis discovery to assess the file storage information
- Computer discovery to collect server information
- NTFS discovery to collect file and folder information

### **To create a File Storage Analysis discovery**

- 1 On the Manage Discoveries page of the Configuration Manager, select **New Discovery | File Storage Analysis**.
- 2 To name the discovery, enter **File Storage Analysis - [Server Name]** so you can identify the discovery easily once you have a list of discoveries.
- 3 Since you only have one cluster, it is automatically selected, and you can click **Next**.
- 4 On the Scopes page, click **Add** to choose the computer to analyze.
- 5 Browse to the computer for which you want to collect data, click **Include**, and click **OK** to close the Browse dialog box.  
If you want to include additional computers, navigate to each one and include it.
- 6 To populate reports with the applicable information to analyze, select the following collection options: **Files, Folders Shares, Owners**.
- 7 Click **Next**.
- 8 Since we want to run this discovery right away, no schedule is necessary and you can click **Finish**.

### **To create a Computer discovery**

- 1 On the Manage Discoveries page of the Configuration Manager, select **New Discovery | Computer**.
- 2 To name the discovery, enter **Computer - [Server Name]** so you can identify the discovery easily once you have a list of discoveries.
- 3 Since you only have one cluster, it is automatically selected, and you can click **Next**.
- 4 On the Scopes page, click **Add** to choose your computer.
- 5 Browse to the same computers as the File Storage Analysis Discovery as you want to collect information from the same computers, click **Include**, and click **OK** to close the Browse dialog box.  
If you included additional computers in the File Storage Analysis discovery, navigate to each one and include it in this discovery as well.
- 6 To populate reports with the applicable information to analyze, select the following collection options: **Shares, Volumes, and Accounts**.
- 7 Click **Next**.
- 8 Since we want to run this discovery right away, no schedule is necessary and you can click **Finish**.

### **To create an NTFS discovery**

- 1 On the Manage Discoveries page of the Configuration Manager, select **New Discovery | NTFS**.
- 2 On the name page, enter **NTFS - [Server Name]** so you can identify the discovery easily once you have a list of discoveries.

- 3 Since you only have one cluster, it is automatically selected, and you can click **Next**.
- 4 On the Scopes page, click **Add** to choose your computer.
- 5 Browse to the same computers as the File Storage Analysis Discovery as you want to collect information from the same computers, click **Include**, and click **OK** to close the Browse dialog box.

If you included additional computers in the File Storage Analysis discovery, navigate to each one and include it in this discovery as well.

To populate reports with the applicable information to analyze, select only the following options:

- For all computers resolved in the discovery, collect: **Folders on all volumes**
  - For this discovery, collect through: **The network share**
  - Recursion Options: **All folder levels**
- 6 Click **Next**.
  - 7 Optionally, you could narrow the discovery by selecting specific files; however, we will collect all files for this scenario.
  - 8 Click **Next**.
  - 9 Since we want to run this discovery right away, no schedule is necessary and you can click **Finish**.

## Run the Discoveries to Collect the Data

You can schedule discoveries or run them on demand. In this case, we want to collect this data right away. Each discovery is broken down into tasks, which are assigned to the node for processing. If you have more than one node, Enterprise Reporter uses load balancing to ensure the most efficient processing. You can track the progress of your discovery.

### *To run the discoveries*

- 1 On the Manage Discoveries page, select the discovery **File Storage Analysis - [Server Name]**.
- 2 Click **Run**.
- 3 Repeat steps 1 and 2 for each of the other discoveries.
- 4 To view the progress of a discovery, click the **Processing** link in the Next Run column.

When a discovery is complete, the status in the Last Run Status column will change. If there were any errors during collection, click the status to view the details of the last run.

## Run the Reports You Need

Once the discovery information is collected, you can run reports against it. When you run a report, it returns data based on the most recent data collected by the discoveries, the selected fields, and any parameter values you enter. Some reports may have required parameters; in this case, the report will not run unless you enter valid parameter values.

To produce the requested information, you must run a File Storage Analysis report in Enterprise Reporter. The Files and Folders report contains the following sections:

- Storage Cleanup Summary - space recommended for cleanup on all servers
- Duplicate Files - space wasted by duplicate files on the servers
- Against Policy File Category - space used by against policy files on the servers (includes wasted space and media files)
- Orphaned Files- space used by files for which the owner is unknown
- Old Data - spaced used by files which have not been accessed in over a year

You can drill down from this report to more detailed reports for each specific section within this report. The following example illustrates this process starting with the Against Policy File Category.

### **To drill down from this report to more detailed reports**

- 1 On the Storage Cleanup report, scroll to the **Against Policy File Category**.
- 2 Click any **server name** and the FSA - Files by Category report is displayed showing the number of files, size, and size on disk for the Against Policy category on that server.
- 3 Click the **Against Policy** category link and the FSA - File Category Details report is displayed showing the 10 file types that are using the most space.
- 4 Scroll down to the corresponding table and click on any **file extension** link (such as JPG) and the NTFS - File Information by Extension report is displayed showing all files with this extension on the selected computers.
- 5 Optionally, click the Next Report or Previous Report buttons in the toolbar to navigate between reports you have viewed.

You can repeat this process starting with the File Storage Analysis Files and Folders report. You can drill down through the various sections of the report to identify files that are duplicate, unused, orphaned or that violate storage usage policy.

## Office 365 and Azure Reporting

If you are required to administer your Office 365 environments, including subscriptions and licenses, Enterprise Reporter can be of assistance by automatically gathering information and reporting on it.

### Scenario

Each week you need a report that shows an overview of your Office 365 tenant. You are going to use three reports to monitor this: one report for an overview of Office 365, one report for tenant settings, and one report for Azure subscription information. You will automate the delivery of the weekly reports to ensure they are always received.

You will need to take the following steps:

- 1 [Setup Enterprise Reporter Azure Applications for Office 365 Discoveries](#)
- 2 [Create a Discovery to Define the Data Collection](#)
- 3 [Run the Discovery to Collect the Data](#)
- 4 [Run the Reports](#)

## Setup Enterprise Reporter Azure Applications for Office 365 Discoveries

To collect from your Office 365 tenant you must configure Enterprise Reporter Tenant applications using the Tenant Application Manager.

### **To setup Enterprise Reporter Azure Applications for Office 365 Discoveries**

- 1 On the **System | Configuration** page of the Configuration Manager, select **Manage tenant applications**.
- 2 Click **Add**, enter the name of your Office 365 tenant and click **OK**.
- 3 In the Tenant Application Manager, your tenant will display with four applications created – Enterprise Reporter Azure Discovery, Enterprise Reporter Azure Resource Discovery, Enterprise Reporter Microsoft Teams Discovery, and Enterprise Reporter OneDrive Discovery.
- 4 To configure each application, click the **Configure** link in the Application Status column.



- 5 Enter credentials for a global administrator account on the tenant and consent to the application permissions.
- 6 Ensure you configure each application. Once configured, the Configure link will change to **Reconfigure**.
- 7 Click **Close**.

## Create a Discovery to Define the Data Collection

In a previous scenario, you have already configured a cluster and now have set up your Enterprise Reporter Tenant applications. You now need to set up discoveries for Azure Active Directory, Exchange Online, Microsoft Teams, and OneDrive. Discoveries define the targets from which data will be collected. Enterprise Reporter uses a “collect all” model. After you run a discovery you can run the reports that include the data that has been collected.

### **To create an Azure Active Directory discovery**

- 1 On the Manage Discoveries page of the Configuration Manager, select **New Discovery | Azure Active Directory**.
- 2 On the Name page, enter **Azure – [Tenant Name]** so you can identify the discovery easily once you have a list of discoveries.
- 3 Since you only have one cluster, it is automatically selected.
- 4 Select an account for the target tenant from the Credential Manager and click **Next**.
- 5 On the Scopes page, the target tenant will be displayed based on the account selected on the previous page. Since we previously configured your Enterprise Reporter Tenant application, no further configuration is required.
- 6 Select only the options necessary for the information you want to collect. Keep the following options: **Users, Groups, Contacts, Roles, Devices, Applications, and Service Principals**.
- 7 Click **Next**.
- 8 Since we want to run this discovery right away, no schedule is necessary and you can click **Finish**.

### **To create an Exchange Online discovery**

- 1 On the Manage Discoveries page of the Configuration Manager, select **New Discovery | Exchange Online**.
- 2 On the Name page, enter **Azure – [Tenant Name]** so you can identify the discovery easily once you have a list of discoveries.
- 3 Since you only have one cluster, it is automatically selected.
- 4 Select an account for the target tenant from the Credential Manager and click **Next**.
- 5 On the Scopes page, the target tenant will be displayed based on the account selected on the previous page. Since we previously configured your Enterprise Reporter Tenant applications, no further configuration is required.
- 6 Select only the options necessary for the information you want to collect. Keep the following options: **Mailboxes, Public Folders, Mail-Enabled Users, Contacts, and Distribution Groups**. Clear the option to **Collect group members**.
- 7 Click **Next**.
- 8 Since we want to run this discovery right away, no schedule is necessary and you can click **Finish**.

### **To create a Microsoft Teams discovery**

- 1 On the Manage Discoveries page of the Configuration Manager, select **New Discovery | MS Teams**.
- 2 On the Name page, enter **Azure – [Tenant Name]** so you can identify the discovery easily once you have a list of discoveries.
- 3 Since you only have one cluster, it is automatically selected.

- 4 Select an account for the target tenant from the Credential Manager and click **Next**.
- 5 On the Scopes page, the target tenant will be displayed based on the account selected on the previous page. Since we previously configured your Enterprise Reporter Tenant applications, no further configuration is required.
- 6 Select only the options necessary for the information you want to collect. Keep the following options: **Channels, Applications, and Files and Folders**.
- 7 Click **Next**.
- 8 Since we want to run this discovery right away, no schedule is necessary and you can click **Finish**.

### **To create a OneDrive discovery**

- 1 On the Manage Discoveries page of the Configuration Manager, select New Discovery | OneDrive.
- 2 On the Name page, enter **Azure – [Tenant Name]** so you can identify the discovery easily once you have a list of discoveries.
- 3 Since you only have one cluster, it is automatically selected.
- 4 Select an account for the target tenant from the Credential Manager and click **Next**.
- 5 On the Scopes page, the target tenant will be displayed based on the account selected on the previous page. Since we previously configured your Enterprise Reporter Tenant applications, no further configuration is required.
- 6 We want to collect all drives to understand usage by user. Select the option to **Collect all drives**.
- 7 To shorten collection time, select only the options you want to collect. Select the following options: **Folders and Files**.
- 8 Click **Next**.
- 9 Since we want to run this discovery right away, no schedule is necessary and you can click Finish.

## **Run the Discovery to Collect the Data**

You can schedule discoveries or run them on demand. In this case, we want to collect this data right away. Each discovery is broken down into tasks that are assigned to the node for processing. If you have more than one node, Enterprise Reporter uses load balancing to ensure the most efficient processing. You can track the progress of your discovery.

### **To run a discovery**

- 1 On the Manage Discoveries page, select each discovery and click **Run**.
- 2 To view the progress of each discovery in the cluster queue, click **View Queue**.
- 3 To see task progress, click the **Processing** link in the Status column.

## **Run the Reports**

Once data is collected, you can run reports against it. When you run a report, it returns data based on the most recent data collected by the discoveries, the selected fields, and any parameter values you enter. Some reports may have required parameters. In this case, the Azure and Office 365 reports require the tenant name to be entered.

To produce the requested information, you must run three reports that are included in Enterprise Reporter.

- Office 365 Overview – shows an overview of Office 365 including Exchange Online, OneDrive, and Microsoft Teams
- Azure Active Directory Summary– shows a summary of your Azure Active Directory
- Azure Subscription Information – shows information on Azure subscriptions

### ***To run each report***

- 1 Open the Report Manager by selecting **Start | Quest | Report Manager**.
- 2 In the connection dialog box, enter the name of the computer where the server is hosted and click Connect.
- 3 On the Report tab, expand Report Library | Office 365 and select your first report, for example Office 365 Overview.
- 4 In the **Include the following tenants** parameter, type the tenant name and click **Add**.  
- OR -  
In the **Include the following tenants** parameter, click **Search**, locate and add the tenant, and click **OK**.
- 5 Click **Run Report**.  
The report appears in a new window. Depending on the amount of data, it may take a few minutes to generate.

Repeat this process for the other reports.

Quest provides software solutions for the rapidly-changing world of enterprise IT. We help simplify the challenges caused by data explosion, cloud expansion, hybrid datacenters, security threats, and regulatory requirements. We are a global provider to 130,000 companies across 100 countries, including 95% of the Fortune 500 and 90% of the Global 1000. Since 1987, we have built a portfolio of solutions that now includes database management, data protection, identity and access management, Microsoft platform management, and unified endpoint management. With Quest, organizations spend less time on IT administration and more time on business innovation. For more information, visit [www.quest.com](http://www.quest.com).

## Technical support resources

Technical support is available to Quest customers with a valid maintenance contract and customers who have trial versions. You can access the Quest Support Portal at <https://support.quest.com>.

The Support Portal provides self-help tools you can use to solve problems quickly and independently, 24 hours a day, 365 days a year. The Support Portal enables you to:

- Submit and manage a Service Request.
- View Knowledge Base articles.
- Sign up for product notifications.
- Download software and technical documentation.
- View how-to-videos.
- Engage in community discussions.
- Chat with support engineers online.
- View services to assist you with your product.