

Quest[®] Enterprise Reporter 3.2 Port Requirements

April 2019

This document outlines the ports required by Enterprise Reporter.

Port Requirements

For the Enterprise Reporter components to communicate, some ports must be open.

- The default port used for communication between the server and the consoles is 7738. This port is also used by the nodes to access the server. The port is configured during installation of the server, and is required in the connection dialog box for both the Configuration Manager and the Report Manager.

You can view the port currently in use on the System | Information page in the Configuration Manager, and the System Information tab in the Report Manager.

- The default port used for communication from the Enterprise Reporter server to the nodes is port 7737. This port may be configured during installation.

This figure outlines the ports used by the Enterprise Reporter components.

Figure 1. Ports used by Enterprise Reporter components.

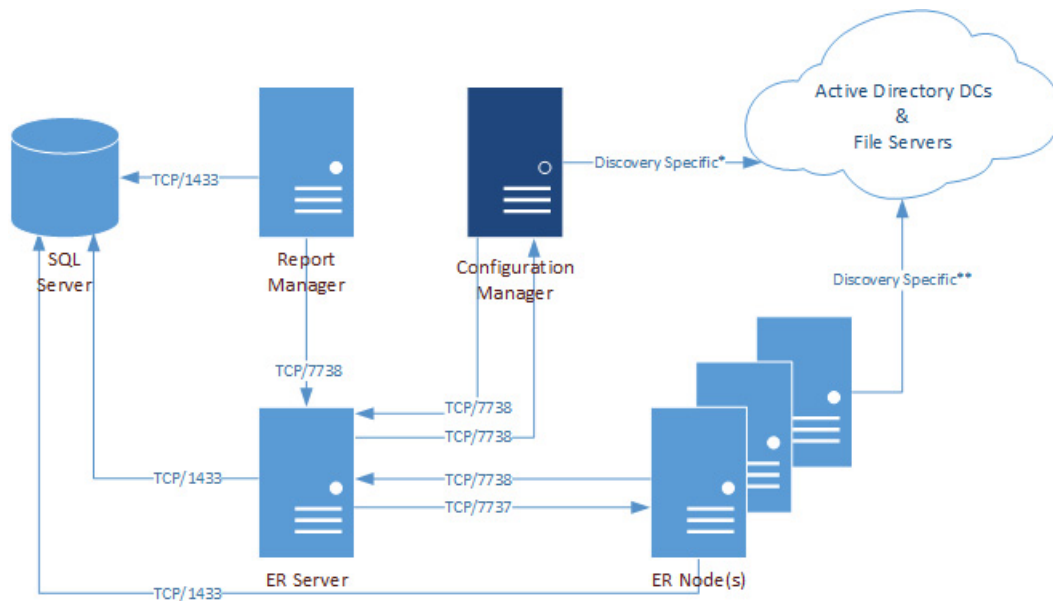

*For more information on ports used when creating a discovery, see Table 1.

**For more information on ports used during data collections, see Table 2.

This table outlines the ports used by all of the Enterprise Reporter components.

Table 1. Ports used by Enterprise Reporter components

Application	Port	Type	Configuration Manager ^a Components				
			Configuration Manager	Report Manager	SQL Server	ER Server	ER Nodes
FTP	20, 21	TCP		X			
SMTP	25	TCP	X	X		X	
WINS / NetBIOS Name Resolution	42	UDP				X	
DNS FQDN Resolution	53	UDP	X	X		X	
Kerberos	88	UDP	X			X	
RPC Service & Endpoint Mapper / WMI	135	UDP	X				
NetBIOS Name Service	137	UDP				X	
NetBIOS Datagram (browsing)	138	UDP	X				
LDAP	389	UDP	X				

Table 1. Ports used by Enterprise Reporter components

Application	Port	Type	Components				
			Configuration Manager ^a	Report Manager	SQL Server	ER Server	ER Nodes
SQL	1433	TCP		X	X	X	X
SQL Server Browser Service	1434	UDP	X	X			
Enterprise Reporter Node	7737	TCP				X	X
Enterprise Reporter Server	7738	TCP	X	X		X	X

a. For the Configuration Manager, also include the ports listed in Table 2.

This table outlines the ports used by all of the Enterprise Reporter discoveries.

Table 2. Ports used by Enterprise Reporter discoveries

Application	Port	Type	Discoveries										
			Active Directory	Azure Active Directory	Azure Resource	Computer	Exchange	Exchange Online	File Storage Analysis	NTFS	OneDrive	Registry	SQL Server
WINS / NetBIOS Name Resolution	42	TCP UDP	X			X	X		X	X		X	X
DNS FQDN Resolution	53	TCP UDP	X			X	X		X	X		X	X
HTTP	80	TCP		X	X		X*	X				X	X
Kerberos	88	TCP UDP	X			X	X*		X	X		X	X
RPC Service & Endpoint Mapper / WMI	135	TCP UDP				X	X**		X	X		X	X
NetBIOS Name Service	137	UDP	X			X	X		X	X		X	X
Remote Registry	139	TCP				X	X		X	X		X	
ICMP						X			X	X		X	X
LDAP	389	TCP UDP	X			X	X		X	X		X	X
HTTPS	443	TCP UDP		X	X							X	X
SMB / Remote Registry	445	TCP	X			X			X	X		X	X
LDAP Secure	636	TCP	X										
DCOM on XP/2003 and below (uses an open port in this range)	1024 - 5000	TCP UDP				X	X		X	X			X
SQL	1433	TCP	X	X	X	X	X	X	X	X	X	X	X
SQL Server Browser Service	1434	UDP											X
LDAP GC	3268	TCP	X				X						
WinRM	5985 5986	TCP UDP											X
Exchange PowerShell	12067	TCP					X**						
DCOM on Vista/2008 and above (uses an open port in this range)	49152 - 65535	TCP UDP				X	X		X	X			X

*Exchange 2010 and higher, **Exchange 2007 only

The following figures outline the ports used by the Enterprise Reporter discoveries.

Figure 2. Ports used by Active Directory collections

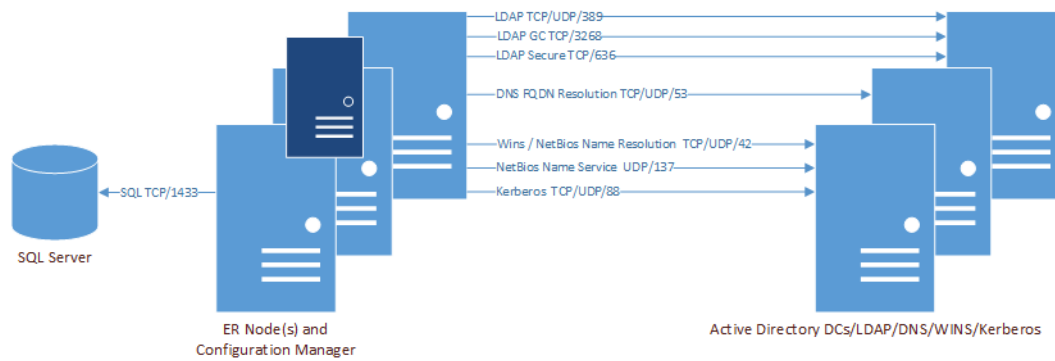

Figure 3. Ports used by Azure and Office 365 collections (Exchange Online, MS Teams, and OneDrive)

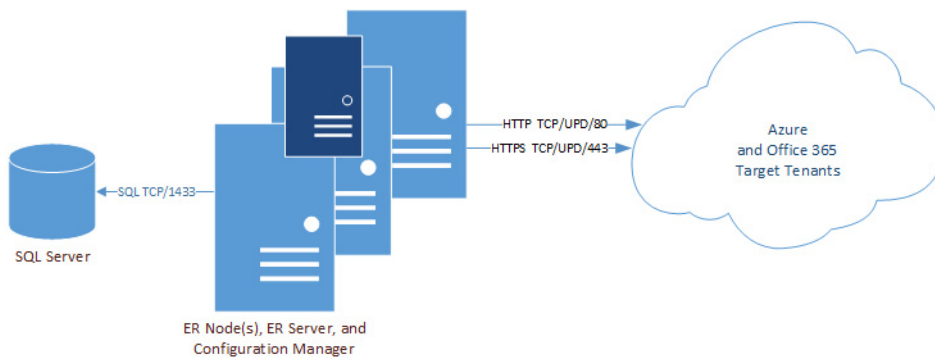

Figure 4. Ports used by Computer collections

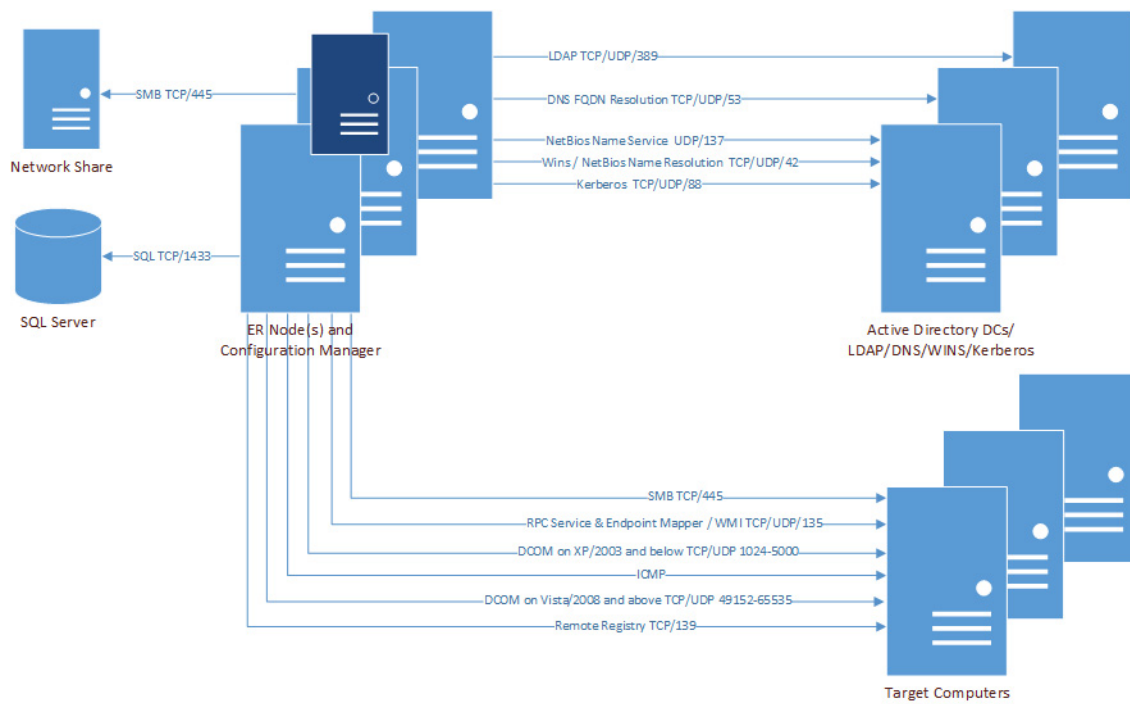

Figure 5. Ports used by Exchange collections

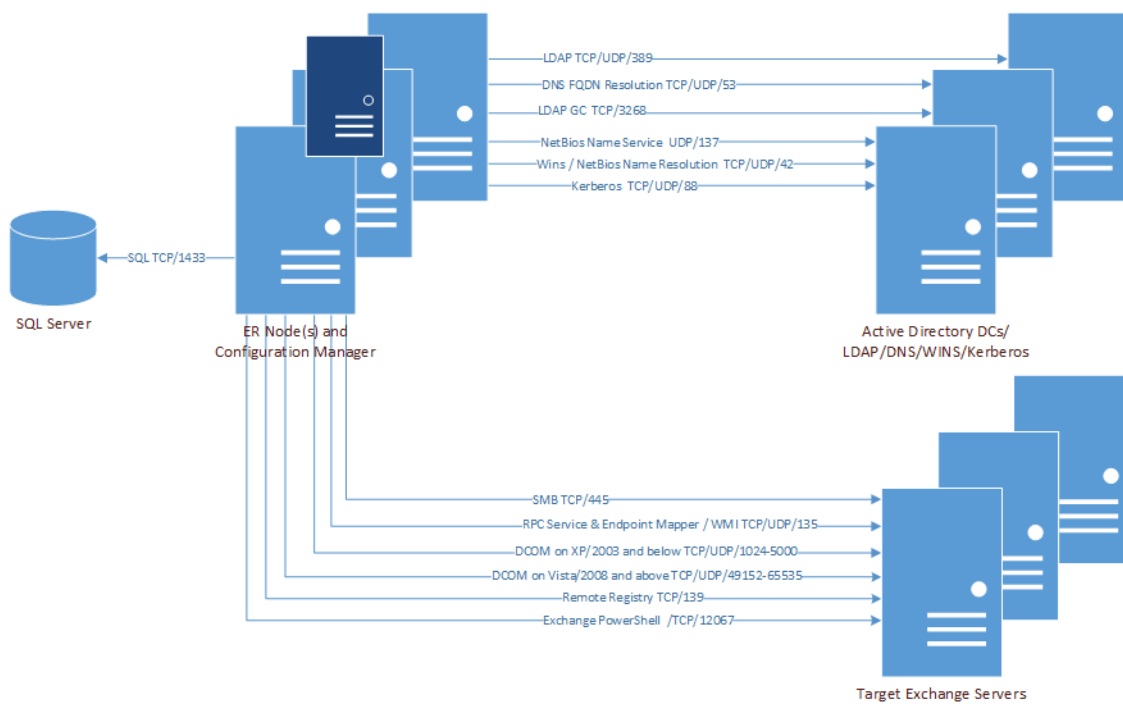

Figure 6. Ports used by File Storage Analysis collections

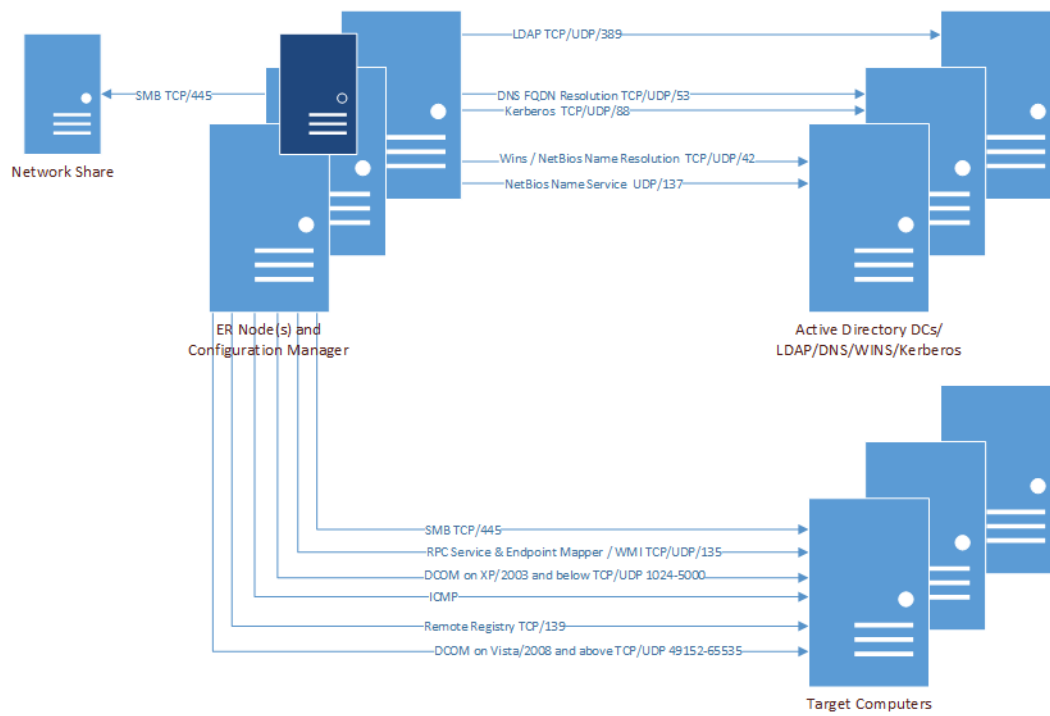

Figure 7. Ports used by NTFS collections

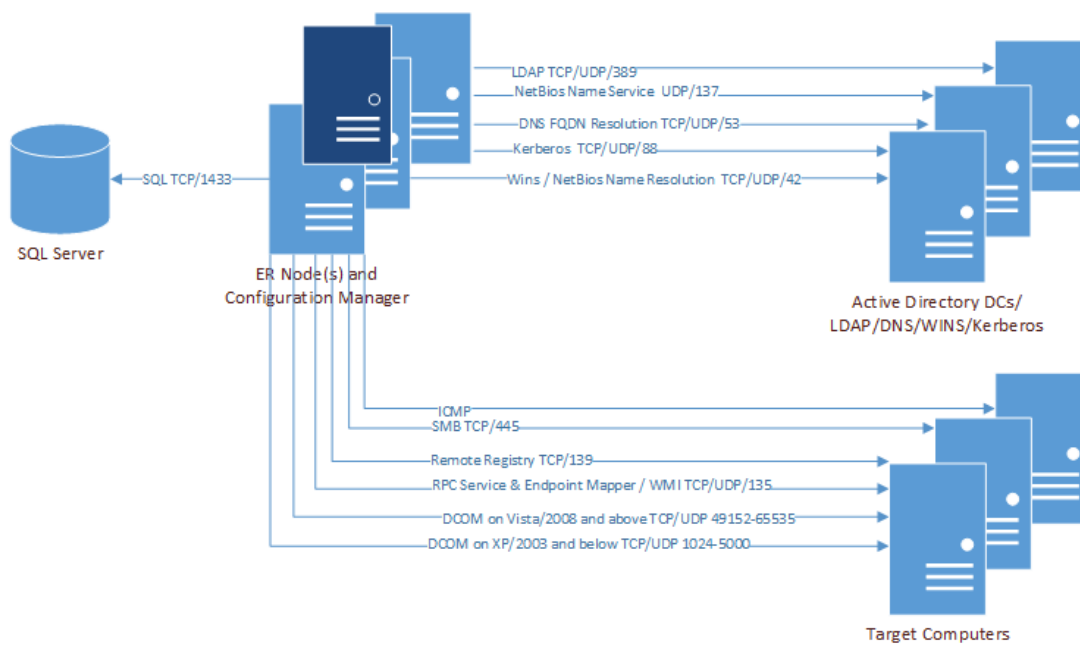

Figure 8. Ports used by Registry collections

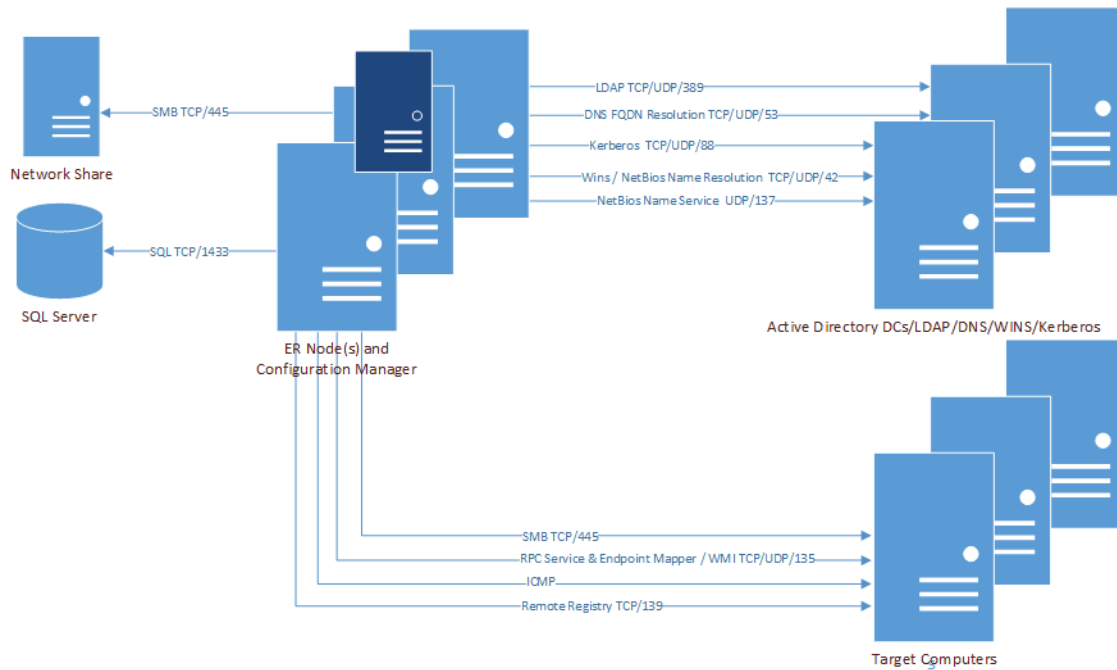
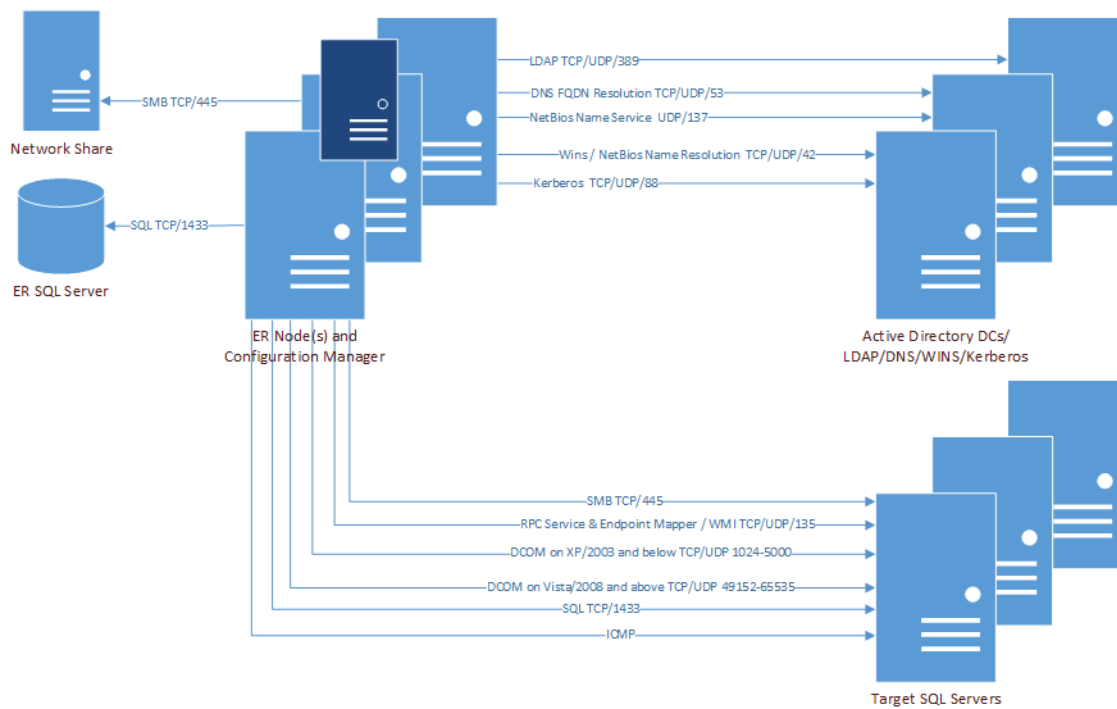

Figure 9. Ports used by SQL collections



About us

Quest provides software solutions for the rapidly-changing world of enterprise IT. We help simplify the challenges caused by data explosion, cloud expansion, hybrid datacenters, security threats, and regulatory requirements. We are a global provider to 130,000 companies across 100 countries, including 95% of the Fortune 500 and 90% of the Global 1000. Since 1987, we have built a portfolio of solutions that now includes database management, data protection, identity and access management, Microsoft platform management, and unified endpoint management. With Quest, organizations spend less time on IT administration and more time on business innovation. For more information, visit www.quest.com.

Technical support resources

Technical support is available to Quest customers with a valid maintenance contract and customers who have trial versions. You can access the Quest Support Portal at <https://support.quest.com>.

The Support Portal provides self-help tools you can use to solve problems quickly and independently, 24 hours a day, 365 days a year. The Support Portal enables you to:

- Submit and manage a Service Request.
- View Knowledge Base articles.
- Sign up for product notifications.
- Download software and technical documentation.
- View how-to-videos.
- Engage in community discussions.
- Chat with support engineers online.
- View services to assist you with your product.

Writer's note: If the product does not have support through normal channels, apply the DoNotPublish condition to the preceding text and delete it from the next paragraph. Modify the statement to reflect the support options available for your release. If no support is available through any channel, use only the first sentence.

This version of Enterprise Reporter does not qualify for product support by Quest Support. Visit the [support portal](#) for documentation and Knowledge Base articles on previous versions, visit the product community, consult the product documentation, or [other method] for support.

© 2019 Quest Software Inc.

ALL RIGHTS RESERVED.

This guide contains proprietary information protected by copyright. The software described in this guide is furnished under a software license or nondisclosure agreement. This software may be used or copied only in accordance with the terms of the applicable agreement. No part of this guide may be reproduced or transmitted in any form or by any means, electronic or mechanical, including photocopying and recording for any purpose other than the purchaser's personal use without the written permission of Quest Software Inc.

The information in this document is provided in connection with Quest Software products. No license, express or implied, by estoppel or otherwise, to any intellectual property right is granted by this document or in connection with the sale of Quest Software products. EXCEPT AS SET FORTH IN THE TERMS AND CONDITIONS AS SPECIFIED IN THE LICENSE AGREEMENT FOR THIS PRODUCT, QUEST SOFTWARE ASSUMES NO LIABILITY WHATSOEVER AND DISCLAIMS ANY EXPRESS, IMPLIED OR STATUTORY WARRANTY RELATING TO ITS PRODUCTS INCLUDING, BUT NOT LIMITED TO, THE IMPLIED WARRANTY OF MERCHANTABILITY, FITNESS FOR A PARTICULAR PURPOSE, OR NON-INFRINGEMENT. IN NO EVENT SHALL QUEST SOFTWARE BE LIABLE FOR ANY DIRECT, INDIRECT, CONSEQUENTIAL, PUNITIVE, SPECIAL OR INCIDENTAL DAMAGES (INCLUDING, WITHOUT LIMITATION, DAMAGES FOR LOSS OF PROFITS, BUSINESS INTERRUPTION OR LOSS OF INFORMATION) ARISING OUT OF THE USE OR INABILITY TO USE THIS DOCUMENT, EVEN IF QUEST SOFTWARE HAS BEEN ADVISED OF THE POSSIBILITY OF SUCH DAMAGES. Quest Software makes no representations or warranties with respect to the accuracy or completeness of the contents of this document and reserves the right to make changes to specifications and product descriptions at any time without notice. Quest Software does not make any commitment to update the information contained in this document.

If you have any questions regarding your potential use of this material, contact:

Quest Software Inc.
Attn: LEGAL Dept.
4 Polaris Way
Aliso Viejo, CA 92656

Refer to our website (<https://www.quest.com>) for regional and international office information.

Patents

Quest Software is proud of our advanced technology. Patents and pending patents may apply to this product. For the most current information about applicable patents for this product, please visit our website at <https://www.quest.com/legal>.

Trademarks

Quest, the Quest logo, and Join the Innovation are trademarks and registered trademarks of Quest Software Inc. For a complete list of Quest marks, visit <https://www.quest.com/legal/trademark-information.aspx>. [Add any non-Quest-owned marks contained in this document here, along with the appropriate attribution. Any references should be listed in the trademark paragraph.] All other trademarks and registered trademarks are the property of their respective owners.

To determine what trademarks to add, review your document for any of the trademarks listed on <https://www.quest.com/legal/trademark-information.aspx>. Any references should be listed in the trademark paragraph.

Legend

-  **WARNING:** A WARNING icon indicates a potential for property damage, personal injury, or death.

-  **CAUTION:** A CAUTION icon indicates potential damage to hardware or loss of data if instructions are not followed.

-  **IMPORTANT NOTE, NOTE, TIP, MOBILE, or VIDEO:** An information icon indicates supporting information.