

Quest® NetVault® Backup Backup
Plug-in for *NDMP* 11.1

User's Guide



© 2017 Quest Software Inc.

ALL RIGHTS RESERVED.

This guide contains proprietary information protected by copyright. The software described in this guide is furnished under a software license or nondisclosure agreement. This software may be used or copied only in accordance with the terms of the applicable agreement. No part of this guide may be reproduced or transmitted in any form or by any means, electronic or mechanical, including photocopying and recording for any purpose other than the purchaser's personal use without the written permission of Quest Software Inc.

The information in this document is provided in connection with Quest Software products. No license, express or implied, by estoppel or otherwise, to any intellectual property right is granted by this document or in connection with the sale of Quest Software products. EXCEPT AS SET FORTH IN THE TERMS AND CONDITIONS AS SPECIFIED IN THE LICENSE AGREEMENT FOR THIS PRODUCT, QUEST SOFTWARE ASSUMES NO LIABILITY WHATSOEVER AND DISCLAIMS ANY EXPRESS, IMPLIED OR STATUTORY WARRANTY RELATING TO ITS PRODUCTS INCLUDING, BUT NOT LIMITED TO, THE IMPLIED WARRANTY OF MERCHANTABILITY, FITNESS FOR A PARTICULAR PURPOSE, OR NON-INFRINGEMENT. IN NO EVENT SHALL QUEST SOFTWARE BE LIABLE FOR ANY DIRECT, INDIRECT, CONSEQUENTIAL, PUNITIVE, SPECIAL OR INCIDENTAL DAMAGES (INCLUDING, WITHOUT LIMITATION, DAMAGES FOR LOSS OF PROFITS, BUSINESS INTERRUPTION OR LOSS OF INFORMATION) ARISING OUT OF THE USE OR INABILITY TO USE THIS DOCUMENT, EVEN IF QUEST SOFTWARE HAS BEEN ADVISED OF THE POSSIBILITY OF SUCH DAMAGES. Quest Software makes no representations or warranties with respect to the accuracy or completeness of the contents of this document and reserves the right to make changes to specifications and product descriptions at any time without notice. Quest Software does not make any commitment to update the information contained in this document.

If you have any questions regarding your potential use of this material, contact:

Quest Software Inc.
Attn: LEGAL Dept.
4 Polaris Way
Aliso Viejo, CA 92656

Refer to our website (<https://www.quest.com>) for regional and international office information.

Patents

Quest Software is proud of our advanced technology. Patents and pending patents may apply to this product. For the most current information about applicable patents for this product, please visit our website at <https://www.quest.com/legal>.

Trademarks

Quest, the Quest logo, Join the Innovation, NetVault SmartDisk, and NetVault are trademarks and registered trademarks of Quest Software Inc. For a complete list of Quest marks, visit <https://www.quest.com/legal/trademark-information.aspx>. All other trademarks and registered trademarks are property of their respective owners.

Legend

-  **WARNING:** A WARNING icon indicates a potential for property damage, personal injury, or death.

-  **CAUTION:** A CAUTION icon indicates potential damage to hardware or loss of data if instructions are not followed.

-  **IMPORTANT NOTE, NOTE, TIP, MOBILE, or VIDEO:** An information icon indicates supporting information.

NetVault Backup Plug-in for NDMP User's Guide
Updated - February 2017
Software Version - 11.1
NCG-101-11.1-EN-02

Contents

Introducing NetVault Backup Plug-in for NDMP	4
About NetVault Backup Plug-in for NDMP	4
Key benefits	4
Feature summary	5
About this document	5
Target audience	5
Recommended additional reading	5
Installing the plug-in	6
Understanding data transfer models	6
Direct-attached or local backups	6
Filer-to-filer or three-way backups	7
Remote backups	8
Heterogeneous three-way NDMP backups	8
Filer to NDMP-compliant network-attached tape backups	9
Prerequisites	9
Installing the plug-in	9
Removing the plug-in	9
Configuring the plug-in	11
Prerequisites	11
Adding an NDMP Server	11
Editing server details	12
Removing an NDMP Server	12
Configuring a NetVault Backup user account	13
Configuring default settings	13
Configuring filer-attached devices	14
About us	15
We are more than just a name	15
Our brand, our vision. Together.	15
Contacting Quest	15
Technical support resources	15

Introducing NetVault Backup Plug-in for NDMP

- [About NetVault Backup Plug-in for NDMP](#)
- [About this document](#)
- [Target audience](#)
- [Recommended additional reading](#)

About NetVault Backup Plug-in for NDMP

NetVault Backup Plug-in for NDMP (Plug-in for NDMP) is an advanced data protection solution for information stored in Network Attached Storage (NAS) devices running Network Data Management Protocol (NDMP). It provides efficient backup and recovery options regardless of the NDMP network configuration model in use. The plug-in also offers advanced features, including browsable volume selection and Direct Access Restore (DAR), which lets you quickly find what must be restored to provide rapid time-to-recovery.

Key benefits

- **Recover faster with Direct Access Restore (DAR):** Filers that support DAR can take advantage of this NDMP feature, which enables fast recovery of whole directories, single files, or subsets of files by recording each file's location within the backup media. This feature eliminates the need for you to read sequentially through the entire backup set to locate and restore individual files.
- **Operate seamlessly between multiple platforms:** The Plug-in for NDMP supports mixed server environments with integrated data protection for UNIX, Windows, Linux, and NAS devices.
- **Choose from multiple backup configuration options:** Increase NAS and network availability by defining NDMP-based backup functions to meet your existing storage environment. The plug-in supports all five NDMP data transfer models. NetVault Backup and Plug-in for NDMP work together to support dynamic sharing of tape devices in a NAS/SAN storage environment using existing tape technology investments.
- **Ensure efficient backup performance:** Experience fast NDMP backups regardless of the type or location of secondary storage devices in use. A filer backup can be performed to any machine with a direct attached device — you are not limited to just the backup server or NAS appliance.
- **Manage and control distributed data centrally:** Use data transfer over the network while maintaining centralized backup administration.

Feature summary

- Fast indexing of backup data
- Directory-level relocation
- Simple point-and-click installation and configuration
- Local backup and restore
- Filer-to-filer backup and restore
- NetVault Backup Server or Client to filer backup and restore
- Dynamic Drive Sharing on SAN between filers and NetVault Backup Server and Clients
- Direct Access Restore
- Incremental Restore
- Browsible backup
- Disk-based backups to NetVault SmartDisk[®], including the ability to deduplicate data

About this document

This guide describes the procedures for installing and configuring the Plug-in *for NDMP*. The information covered in this guide is common to all supported NAS appliances using NDMP. For additional notes on your particular filer, see the *Quest NetVault Backup Plug-in for NDMP Application Notes* which are intended as a supplement to this guide. The Application Notes provide more installation and configuration notes, outline the backup and restore procedures, and contain troubleshooting instructions specific to your filer.

Target audience

This guide is intended for system administrators responsible for installing, configuring, and using the Plug-in *for NDMP*. An understanding of filer administration and the host platform is assumed.

Recommended additional reading

- NetVault Backup documentation
 - *Quest NetVault Backup Installation Guide*: This guide provides details on installing the NetVault Backup Server and Client software.
 - *Quest NetVault Backup Administrator's Guide*: This guide explains how to use NetVault Backup and describes the functionality common to all plug-ins.
 - *Quest NetVault Backup CLI Reference Guide*: This guide provides a description of the command-line utilities.
 - *Quest NetVault Backup Plug-in for NDMP Application Notes*: These notes provide filer-specific information.

You can download these guides from <https://support.quest.com/technical-documents>.

- NAS device documentation: *Administrator's Guide for your NDMP-based NAS appliance*

Installing the plug-in

- Understanding data transfer models
- Prerequisites
- Installing the plug-in
- Removing the plug-in

Understanding data transfer models

The Plug-in for *NDMP* supports the following data transfer models:

- Direct-attached or local backups
- Filer-to-filer or three-way backups
- Remote backups
- Heterogeneous three-way NDMP backups
- Filer to NDMP-compliant network-attached tape backups

Direct-attached or local backups

Figure 1. Direct-attached or local backup model

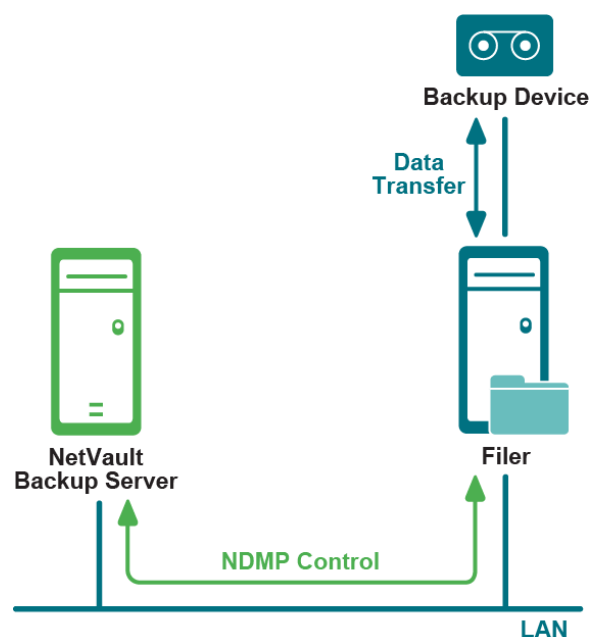

In the direct-attached or local backup model, the NetVault Backup Server instructs the filer to perform backups to the device directly attached to the filer (through Fibre Channel or SCSI). The filer transfers the backup index information to the server using NDMP over the network. During restores, the filer reads the data from the direct-attached device on server instruction. The actual data is not transmitted over the network during backup or restore, eliminating network congestion altogether.

Filer-to-filer or three-way backups

Figure 2. Filer-to-filer or three-way backup model

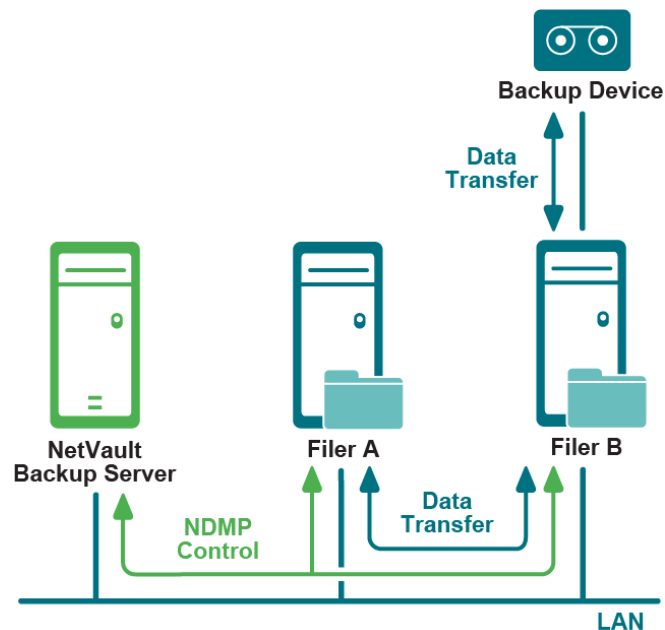

In the filer-to-filer or three-way backup model, the NetVault Backup Server instructs Filer A to perform backups to the tape device attached to Filer B. Filer A transfers the data and backup index information over the network. Filer B transfers the data directly to the device; it transfers the backup index information to the server using NDMP over the network. This model allows sharing of tape libraries among multiple filers.

Remote backups

Figure 3. Remote backup model

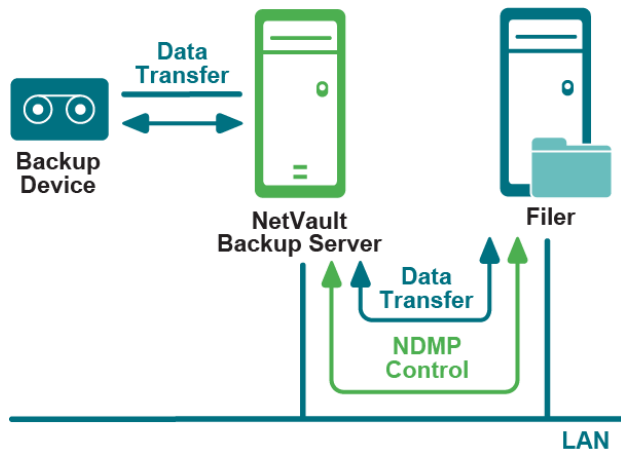

In the filer-to-server (filer-to-client) or remote backup model, the NetVault Backup Server instructs the filer to perform backups to tape devices attached to the server. The filer transfers the data and index information to the server using NDMP over the network.

Heterogeneous three-way NDMP backups

Figure 4. Heterogeneous three-way NDMP backup model

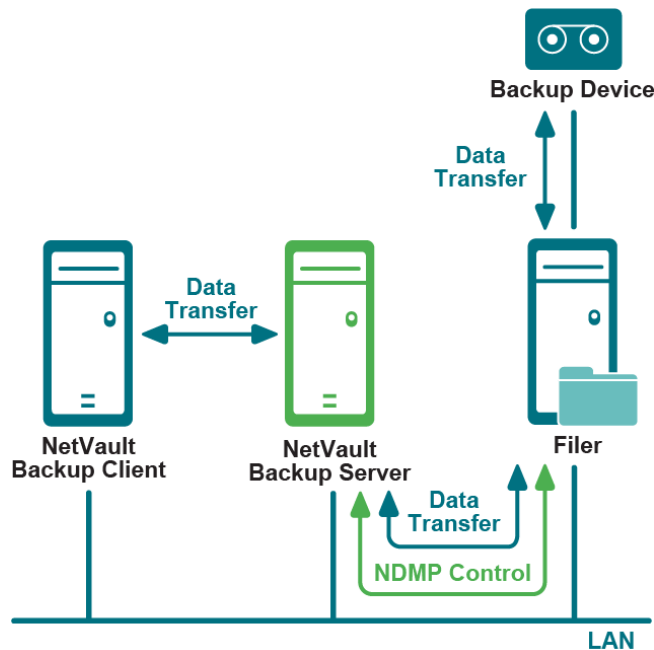

The heterogeneous three-way NDMP backup model is similar to the direct-attached model, but in this model the NetVault Backup machines on the network also use the filer-attached tape device for backups and restores.

Filer to NDMP-compliant network-attached tape backups

Figure 5. Filer to NDMP-compliant network-attached tape backups

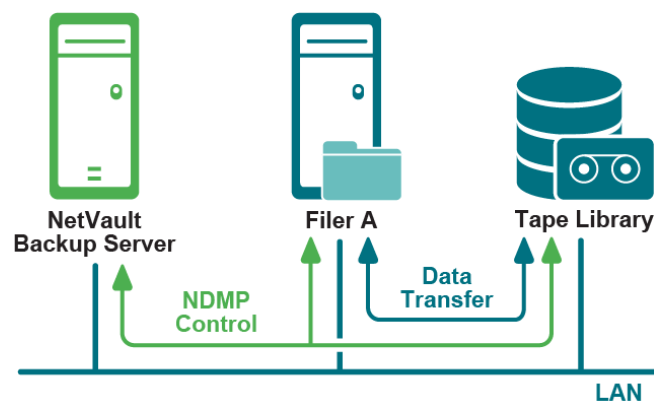

In this model, the NetVault Backup Server instructs the filer to perform backups to the NDMP-compliant network-attached storage device. The filer uses NDMP over the network to transfer the data to the storage device and backup index information to the NetVault Backup Server. The network-attached storage device can be shared by one or more filers, NetVault Backup Server and any number of NetVault Backup Clients.

Prerequisites

For filer-specific installation requirements, see the relevant *Quest NetVault Backup Plug-in for NDMP Application Notes*.

Installing the plug-in

- 1 In the Navigation pane, click **Manage Clients**.
- 2 In the **NetVault Backup Clients** table, select the client on which you want to install the plug-in, and click **Manage**.
- 3 At the lower-right corner of the **Installed Software** table, click the **Install Plugin** button (🔍).
- 4 Click **Choose Plug-in File**, and in the browse window, navigate to the location of the “.npx” installation file for the plug-in (on the installation CD or the directory to which the file was downloaded from the website).
- 5 Select the file named **ndm-x-x-x-x.npx** (x-x-x-x represents the version, build, and platform numbers), and click **Next** to begin installation.

After the plug-in is installed successfully, a message is displayed.

Removing the plug-in

- 1 In the Navigation pane, click **Manage Clients**.
- 2 In the **NetVault Backup Clients** list, select the client on which the plug-in is installed, and click **Manage**.

- 3 In the **Installed Plug-ins** table, select **NDMP Client**, and click the **Remove Plugin** button ().
- 4 In the confirmation dialog box, click **Remove**.

Configuring the plug-in

- [Prerequisites](#)
- [Adding an NDMP Server](#)
- [Configuring a NetVault Backup user account](#)
- [Configuring default settings](#)
- [Configuring filer-attached devices](#)

Prerequisites

Before you start the configuration procedure, verify that the following requirements are met:

- To use UTF-8 encoding, do the following:
 - Enable UTF-8 encoding on the filer and all volumes.
 - Configure appropriate language-type on all volumes.

To determine if UTF-8 encoding is supported on the target filer and for instructions on configuring the Character Set Encoding on the filer, see the relevant filer documentation.

- For filer-specific configuration notes, see relevant *Quest NetVault Backup Plug-in for NDMP Application Notes*.

Adding an NDMP Server

To start using the plug-in for backups and restores, you must add the applicable filers to the plug-in, and configure a user account to log in to the filer.

- 1 In the Navigation pane, click **Create Backup Job**.

— or —

In the Navigation pane, click **Guided Configuration**, and then on the **NetVault Configuration Wizard** page, click **Create Backup Jobs**.

- 2 To open the **NetVault Backup Selections** page, click **Create New** next to the **Selections** list.
- 3 Open the NetVault Backup Server, and select **NDMP Client**.
- 4 In the **Actions** list, click **Add Server**.
- 5 In the **NDMP Server** dialog box, configure the following settings.

Option	Description
Name	Type a name for the filer. The filer name must be unique. You can assign the actual name of the filer to easily identify it in the NetVault Backup environment. NOTE: You cannot change the server name after it is configured.
Address(es)	Type the IP address of the filer.

Option	Description
Port	By default, the filer is configured to listen on port number 10000. Unless otherwise required, do not change the listener port for the filer.
Account	Specify a user account that can be used to log in to the filer. The user account must have necessary privileges to perform NDMP backups and restores.
Password	Type the password for the user account.
Use UTF-8 Conversions	To convert the filenames and display them correctly according to the locale configured on the NetVault Backup WebUI, select this check box. This feature can only be used if the filer supports UTF-8 encoding. To use this feature, do the following: <ul style="list-style-type: none"> • Enable UTF-8 conversion on the filer. • Set the appropriate language type on each target volume. • Set the configuration option Codepage for UTF-8 Conversions. For more information, see Configuring default settings. <p>NOTE: For NetApp filers, the actual conversion is specified on a per-job basis by setting the option Request Unicode File Information in the Backup Options Set. However, the Use UTF-8 Conversions check box must be selected to use this feature.</p>

- 6 To add the filer, click **OK**.

Editing server details

- 1 Start the Backup Job Wizard, and click **Create New** next to the **Selections** list.
- 2 Open the NetVault Backup Server, and then open **NDMP Client**.
- 3 Select the filer, and in the **Actions** list, click **Edit Server**.
- 4 Reconfigure the applicable settings.

For more information about these settings, see [Adding an NDMP Server](#).

Note the following:

- You cannot change the server name.
- To change the password, select the **New Password** check box, and type the password.

- 5 To save the new settings, click **OK**.

Removing an NDMP Server

- 1 Start the Backup Job Wizard, and click **Create New** next to the **Selections** list.
- 2 Open the NetVault Backup Server, and then open **NDMP Client**.
- 3 Select the filer, and in the **Actions** list, click **Remove Server**.
- 4 In the confirmation dialog box, click **OK**.

Configuring a NetVault Backup user account

When backing up multiple volumes, the plug-in uses the “default” user account to run child jobs. If you assign a new password to this user account, you must also update the account details in the plug-in. Otherwise, the backup jobs that include multiple volumes report an error (“unable to log in to auditor, check account and password are valid”) and fail.

To configure password for the “default” user account:

- 1 Start the Backup Job Wizard, and click **Create New** next to the **Selections** list.
- 2 Open the NetVault Backup Server, and then open **NDMP Client**.
- 3 Select the filer, and in the **Actions** list, click **Set Account**.
- 4 In the **NetVault Account** dialog box, provide the following information:
 - **Account:** Type “default”, which is the user account used to run the subjobs.
 - **New Password:** Select the **New Password** check box, and specify the password set for the “default” account.
- 5 To save the information, click **OK**.

Configuring default settings

The default settings apply globally to all NDMP Servers added to the plug-in.

- 1 Start the Backup Job Wizard, and click **Create New** next to the **Selections** list. Open the NetVault Backup Server. Select **NDMP Client**, and in the **Actions** list, click **Configure**.

— or —

In the Navigation pane, click **Change Settings**. On the **Configuration** page, click **Server Settings**, and then click **Plugin Options**.

- 2 Under **NDMP Backup Log Filters**, configure the following settings.

Option	Description
Filter 1	To filter log messages generated during backup jobs, use these settings. The messages that contain the strings specified in these boxes are not displayed on the View Logs page. Each box can contain one filter string. Thus, you can specify a maximum of 10 filter strings in the filter boxes.
Filter 2	
...	
Filter 10	

- 3 Under **NDMP Backup Configuration**, configure the following settings.

Option	Description
Maximum File Buffer Size	To increase the buffer size for file transfer to improve performance, use this setting. The maximum buffer size value depends on the resources available on the NAS Filer. A large buffer size can have a negative impact on the data transfer and overall performance.
Maximum Index Buffer Size	To increase the buffer size for the transfer of backup index entries to improve performance, use this setting. The maximum buffer size value depends on the resources available on the NAS Filer. A large buffer size can have a negative impact the data transfer and overall performance.

Option	Description
Codepage for UTF-8 Conversions	Type the codepage identifier for UTF-8 conversions. Use this option with the Use UTF-8 Conversions option described in Adding an NDMP Server . Translations depend on the configuration, locale, and code sets installed on the system. For a list of codepage values, see the operating system documentation.
Use APM UTF-8 Conversion	To store and index UTF-8 character sets for browsing, select this check box. This setting allows you to browse the files in a native UTF supported language, such as Japanese. Without this setting, the plug-in indexes the files by filer-specific NDMP metadata.
Delete Unsuccessful Jobs On Completion	By default, NetVault Backup removes the subjobs for Phase 2 backups whether the phase completes successfully or fails. To change the default behavior, use this setting. If you clear this check box, the subjobs generated during Phase 2 backups are removed only if both Phase 1 and Phase 2 backups complete successfully. NOTE: If a Phase 1 job fails, the sub-jobs generated during this phase are retained even if you select this check box.

i **NOTE:** After configuring UTF-8 encoding setting on the filer, filer volumes, and plug-in, Quest recommends that you perform a test backup of some data on the relevant volumes. Then, browse these savesets using the Restore Job Wizard to ensure that the names of the directories and files are displayed correctly. This test is necessary because the UTF-8 name translations are received from the filer. If the filer fails to supply the names in UTF-8 format, it can cause corruption or truncation of the file and directory names.

- 4 Under **NDMP Restore Log Filters**, configure the following settings:

Option	Description
Filter 1	To filter log messages generated during restore jobs, use these settings. The messages that contain the strings specified in these boxes are not displayed on the View Logs page. Each box can contain one filter string. Thus, you can specify a maximum of 10 filter strings in the filter boxes.
Filter 2	
...	
Filter 10	Consider the following while configuring the filter expressions for NDMP restore logs: <ul style="list-style-type: none"> When performing a restore, an error message is reported every time a file is overwritten. These errors can quickly add up to thousands of log messages, causing system degradation. The Filter 1 box contains a default expression "Warning: cannot create directory" that automatically blocks this type of error messages. Quest recommends that you do not change the default expression in the Filter 1 box. By default, the text in Filter 1 is displayed in English regardless of the locale setting for NetVault Backup. This string should match the log messages that the NDMP Filer sends, indicating that it was unable to create a directory while performing a restore. If the filer log messages are in a language other than English, then the text in Filter 1 should be changed to match the message.

- 5 To save the settings and close the dialog box, click **OK**.

Configuring filer-attached devices

For administration of backups and restores to direct-attached devices, the device must be added to the NetVault Backup Server. For more information about adding storage devices to the NetVault Backup Server, see the *Quest NetVault Backup Administrator's Guide*.

We are more than just a name

We are on a quest to make your information technology work harder for you. That is why we build community-driven software solutions that help you spend less time on IT administration and more time on business innovation. We help you modernize your data center, get you to the cloud quicker and provide the expertise, security and accessibility you need to grow your data-driven business. Combined with Quest's invitation to the global community to be a part of its innovation, and our firm commitment to ensuring customer satisfaction, we continue to deliver solutions that have a real impact on our customers today and leave a legacy we are proud of. We are challenging the status quo by transforming into a new software company. And as your partner, we work tirelessly to make sure your information technology is designed for you and by you. This is our mission, and we are in this together. Welcome to a new Quest. You are invited to Join the Innovation™.

Our brand, our vision. Together.

Our logo reflects our story: innovation, community and support. An important part of this story begins with the letter Q. It is a perfect circle, representing our commitment to technological precision and strength. The space in the Q itself symbolizes our need to add the missing piece—you—to the community, to the new Quest.

Contacting Quest

For sales or other inquiries, visit <https://www.quest.com/company/contact-us.aspx> or call +1-949-754-8000.

Technical support resources

Technical support is available to Quest customers with a valid maintenance contract and customers who have trial versions. You can access the Quest Support Portal at <https://support.quest.com>.

The Support Portal provides self-help tools you can use to solve problems quickly and independently, 24 hours a day, 365 days a year. The Support Portal enables you to:

- Submit and manage a Service Request.
- View Knowledge Base articles.
- Sign up for product notifications.
- Download software and technical documentation.
- View how-to-videos.
- Engage in community discussions.
- Chat with support engineers online.
- View services to assist you with your product.