

Quest™ Enterprise Reporter 3.0

Port Requirements

This document outlines the ports required by Enterprise Reporter.

Port Requirements

For the Enterprise Reporter components to communicate, some ports must be open.

- The default port used for communication between the server and the consoles is 7738. This port is also used by the nodes to access the server. The port is configured during installation of the server, and is required in the connection dialog box for both the Configuration Manager and the Report Manager.

You can view the port currently in use on the System | Information page in the Configuration Manager, and the System Information tab in the Report Manager.

- The default port used for communication from the Enterprise Reporter server to the nodes is port 7737. This port may be configured during installation.

This figure outlines the ports used by the Enterprise Reporter components.

Figure 1. Ports used by Enterprise Reporter components.

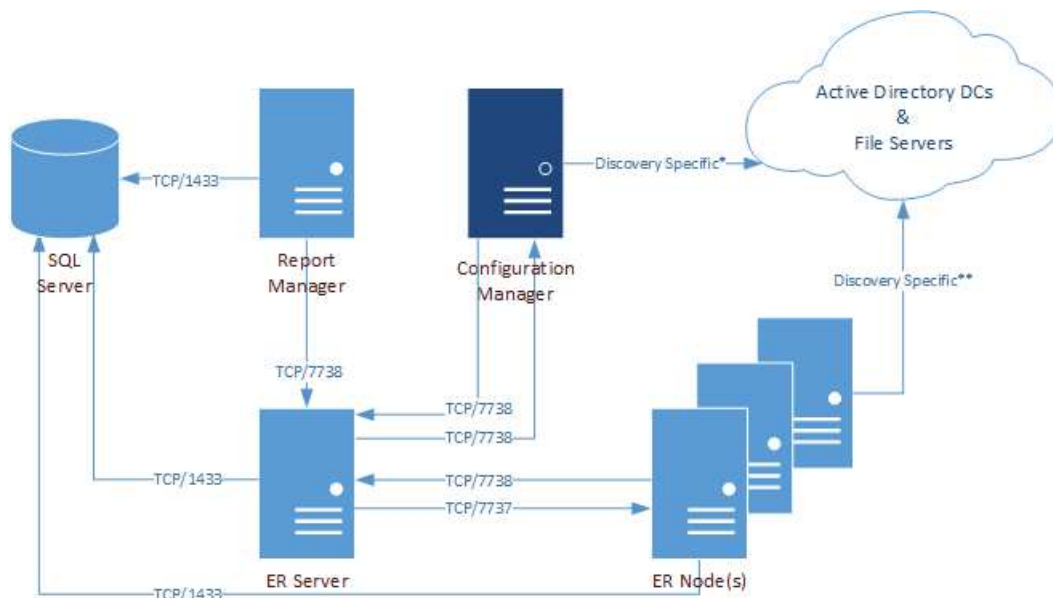

*For more information on ports used when creating a discovery, see [Table 1](#).

**For more information on ports used during data collections, see [Table 2](#).

This table outlines the ports used by all of the Enterprise Reporter components.

Table 1. Ports used by Enterprise Reporter components

Application	Port	Type	Components				
			Configuration Manager ^a	Report Manager	SQL Server	ER Server	ER Nodes
FTP	20, 21	TCP		X			
SMTP	25	TCP	X	X		X	
WINS / NetBIOS Name Resolution	42	TCP UDP					X
DNS FQDN Resolution	53	TCP UDP	X	X		X	
Kerberos	88	TCP UDP	X				X
RPC Service & Endpoint Mapper / WMI	135	TCP UDP	X				
NetBIOS Name Service	137	UDP					X
NetBIOS Datagram (browsing)	138	UDP	X				
LDAP	389	TCP UDP	X				
SQL	1433	TCP		X	X	X	X
SQL Server Browser Service	1434	TCP UDP	X	X			
Enterprise Reporter Node	7737	TCP				X	X
Enterprise Reporter Server	7738	TCP	X	X		X	X

a. For the Configuration Manager, also include the ports listed in [Table 2](#).

This table outlines the ports used by all of the Enterprise Reporter discoveries.

Table 2. Ports used by Enterprise Reporter discoveries

Application	Port	Type	Discoveries									
			Active Directory	Azure Active Directory	Computer Exchange	Exchange Online	File Storage Analysis	NTFS	OneDrive	Registry	SQL Server	
WINS / NetBIOS Name Resolution	42	TCP UDP	X		X	X		X	X		X	X
DNS FQDN Resolution	53	TCP UDP	X		X	X		X	X		X	X
HTTP	80	TCP		X	X*	X				X		
Kerberos	88	TCP UDP	X		X	X*		X	X		X	X
RPC Service & Endpoint Mapper / WMI	135	TCP UDP			X	X**		X	X		X	X
NetBIOS Name Service	137	UDP	X		X	X		X	X		X	X
Remote Registry	139	TCP			X	X		X	X		X	
ICMP					X			X	X		X	X
LDAP	389	TCP UDP	X		X	X		X	X		X	X
HTTPS	443	TCP UDP		X						X		
SMB / Remote Registry	445	TCP	X		X			X	X		X	X
LDAP Secure	636	TCP	X									
DCOM on XP/2003 and below (uses an open port in this range)	1024 - 5000	TCP UDP			X	X		X	X			X
SQL	1433	TCP	X	X	X	X	X	X	X	X	X	X
LDAP GC	3268	TCP	X			X						
Exchange PowerShell	12067	TCP				X**						
DCOM on Vista/2008 and above (uses an open port in this range)	49152 - 65535	TCP UDP			X	X		X	X			X

*Exchange 2010 and higher, **Exchange 2007 only

The following figures outline the ports used by the Enterprise Reporter discoveries.

Figure 2. Ports used by Active Directory collections

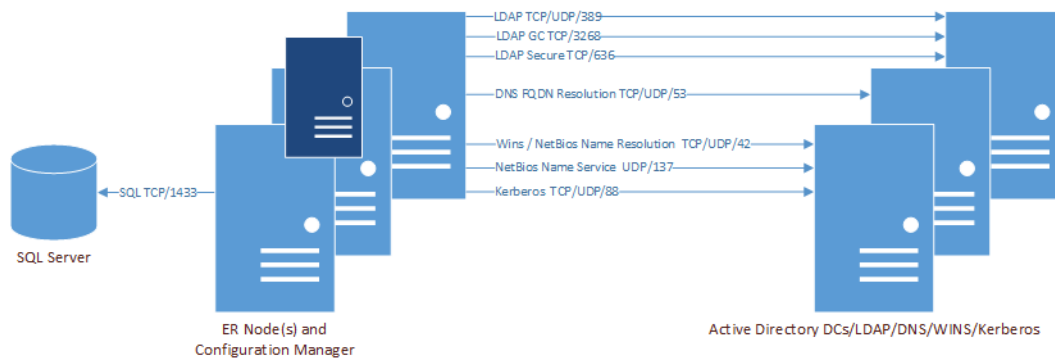

Figure 3. Ports used by Azure and OneDrive collections

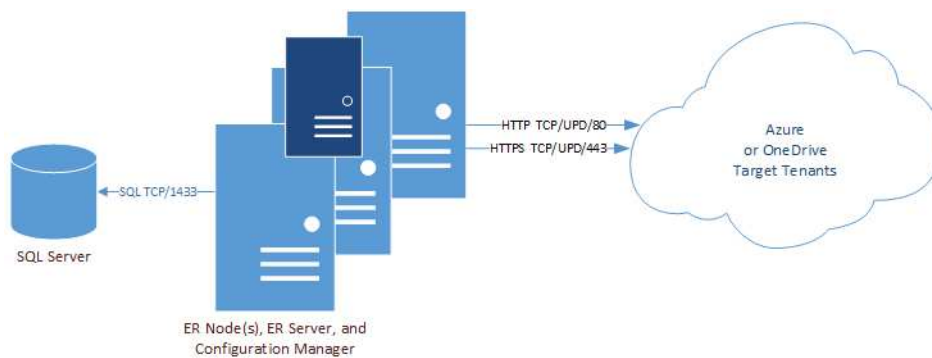

Figure 4. Ports used by Computer collections

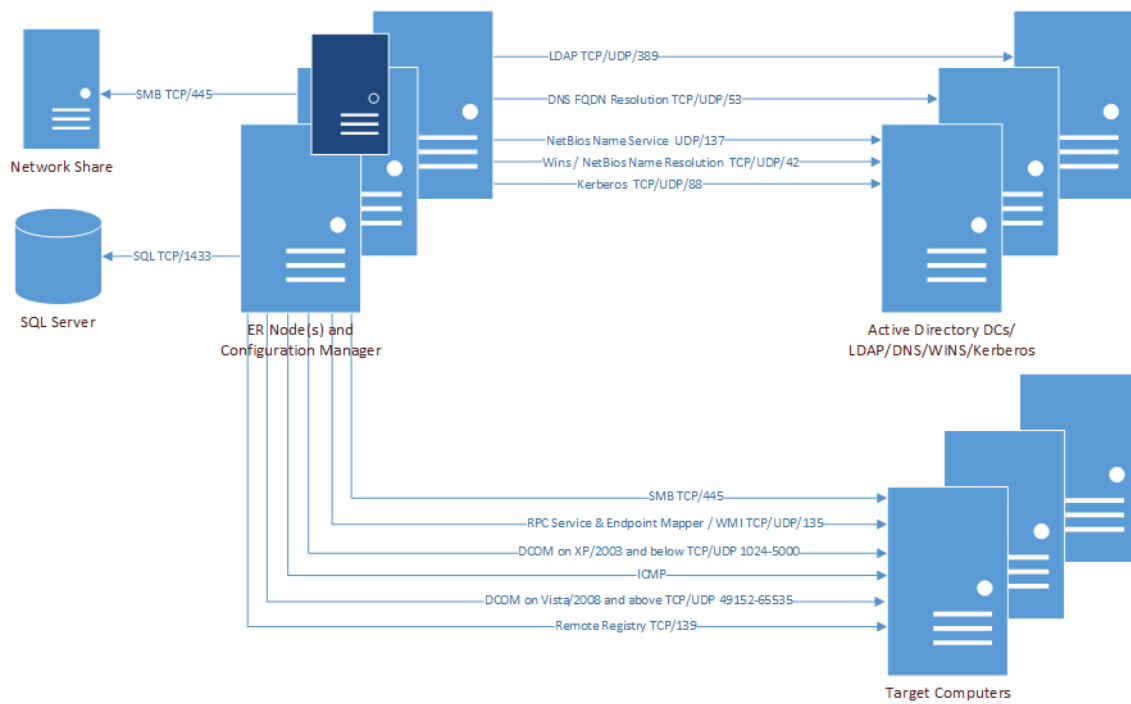

Figure 5. Ports used by Exchange collections

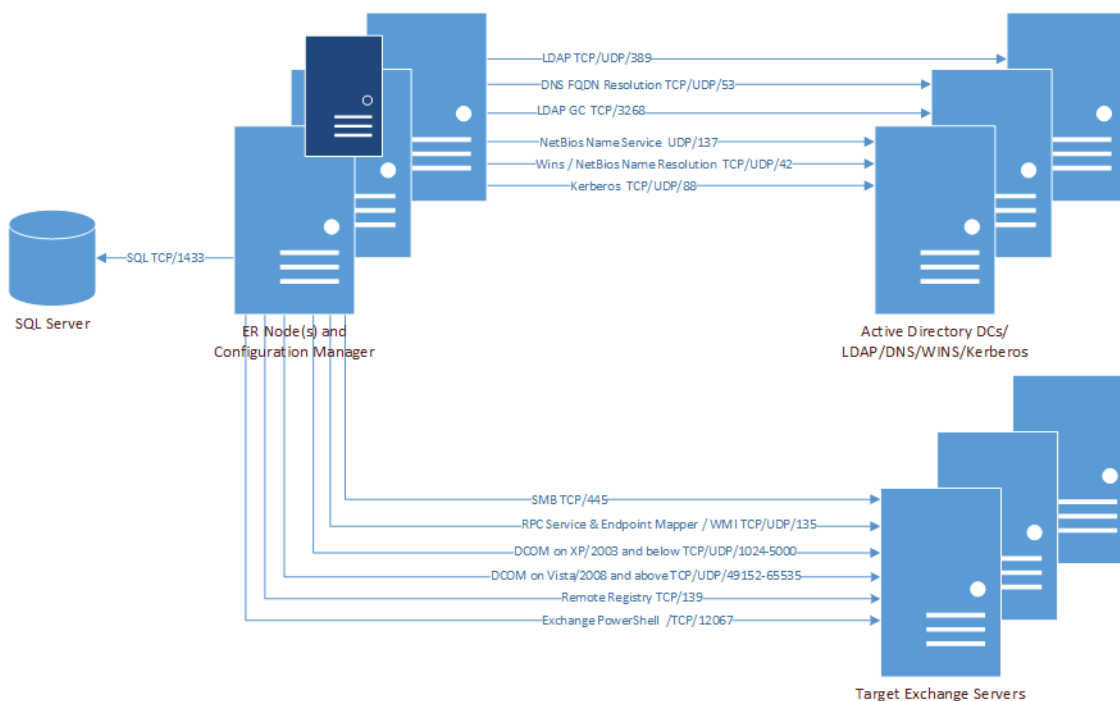

Figure 6. Ports used by Exchange Online collections

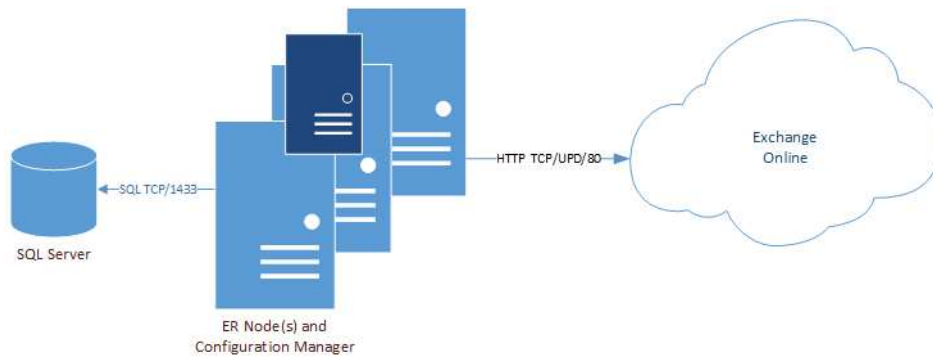

Figure 7. Ports used by File Storage Analysis collections

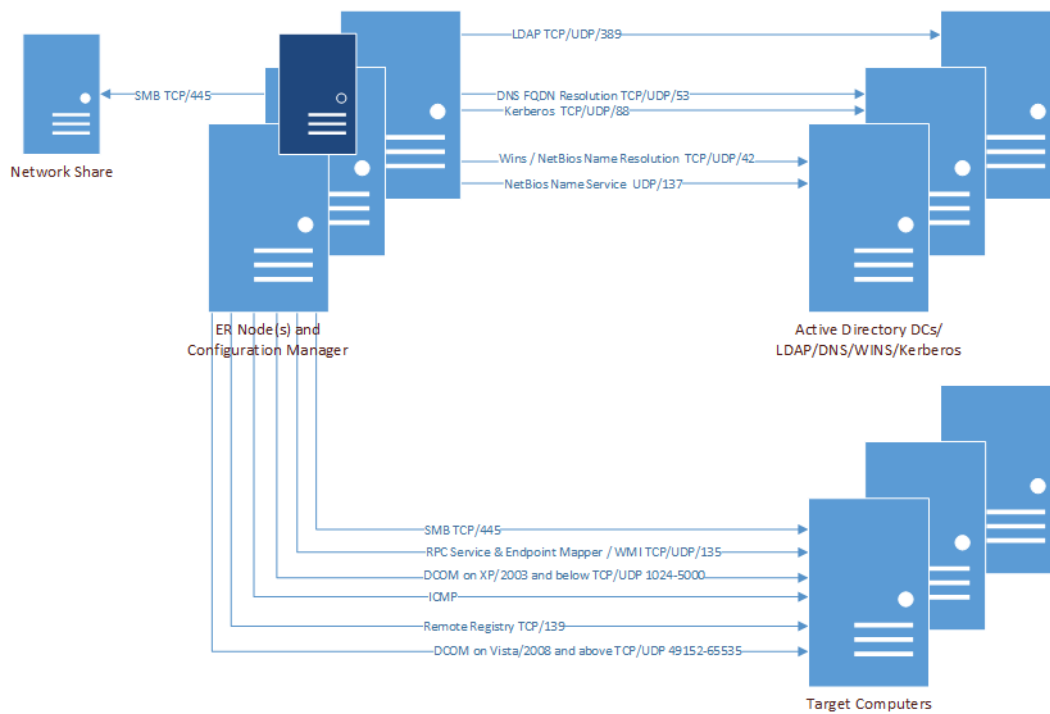

Figure 8. Ports used by NTFS collections

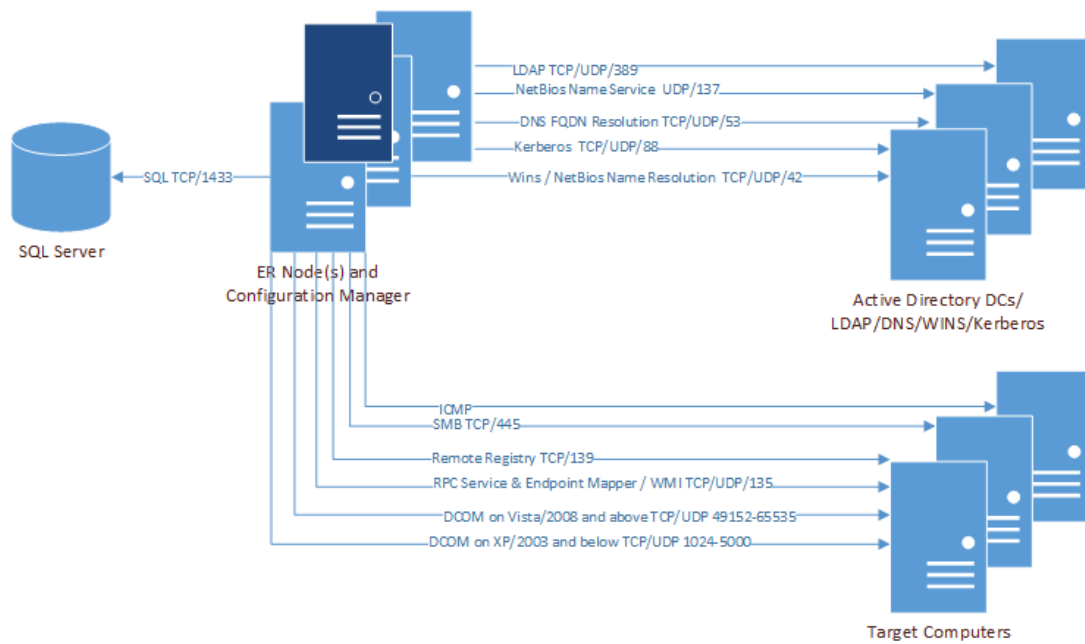

Figure 9. Ports used by Registry collections

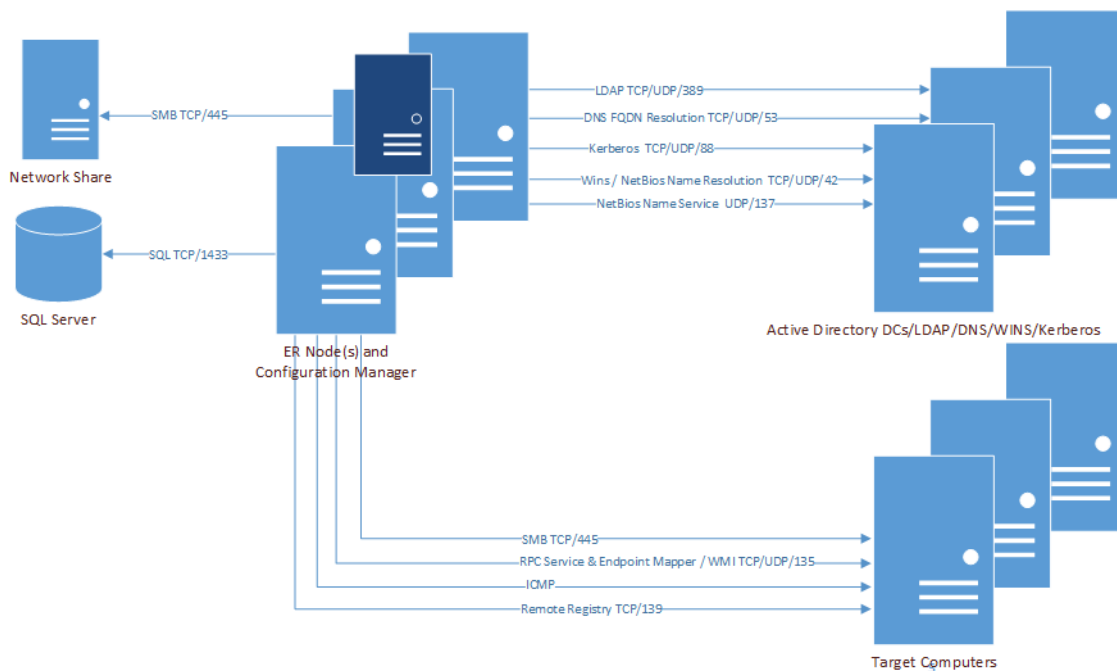
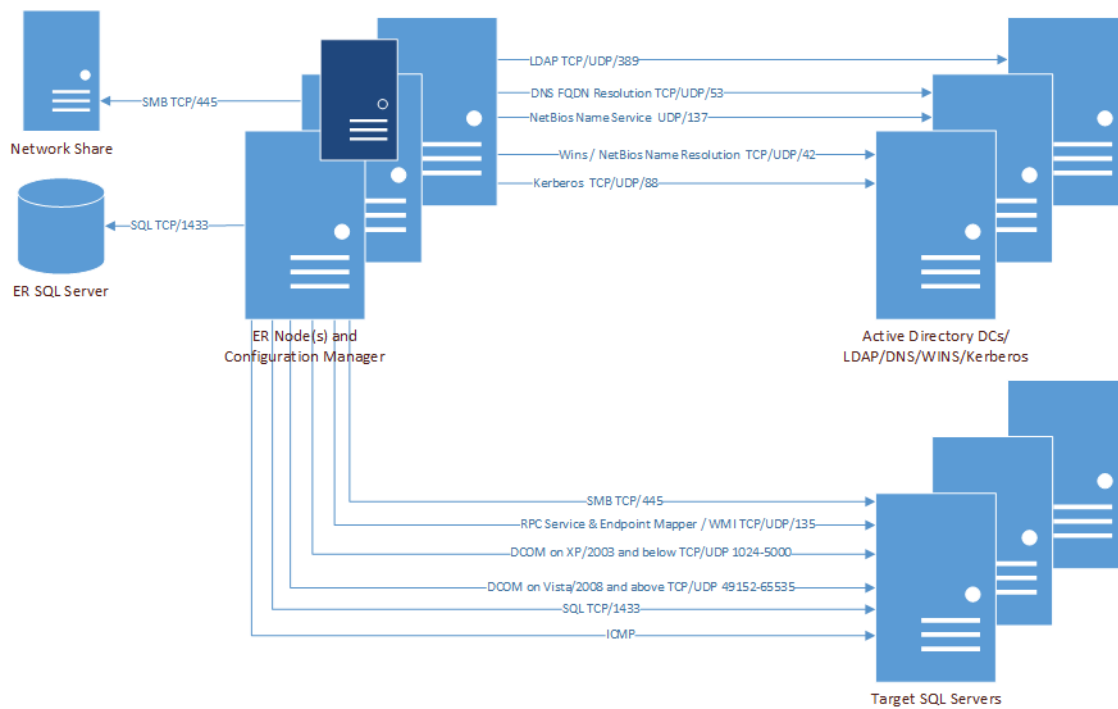

Figure 10. Ports used by SQL collections



About Quest

We are more than just a name

We are on a quest to make your information technology work harder for you. That is why we build community-driven software solutions that help you spend less time on IT administration and more time on business innovation. We help you modernize your data center, get you to the cloud quicker and provide the expertise, security and accessibility you need to grow your data-driven business. Combined with Quest's invitation to the global community to be a part of its innovation, and our firm commitment to ensuring customer satisfaction, we continue to deliver solutions that have a real impact on our customers today and leave a legacy we are proud of. We are challenging the status quo by transforming into a new software company. And as your partner, we work tirelessly to make sure your information technology is designed for you and by you. This is our mission, and we are in this together. Welcome to a new Quest. You are invited to Join the Innovation.

Our brand, our vision. Together.

Our logo reflects our story: innovation, community and support. An important part of this story begins with the letter Q. It is a perfect circle, representing our commitment to technological precision and strength. The space in the Q itself symbolizes our need to add the missing piece—you—to the community, to the new Quest.

Contacting Quest

For sales or other inquiries, visit <https://quest.com/contact>.

Technical support resources

Technical support is available to Quest customers with a valid maintenance contract and customers who have trial versions. You can access the Quest Support Portal at <https://support.quest.com>.

The Support Portal provides self-help tools you can use to solve problems quickly and independently, 24 hours a day, 365 days a year. The Support Portal enables you to:

- Submit and manage a Service Request.
- View Knowledge Base articles.
- Sign up for product notifications.
- Download software and technical documentation.
- View how-to-videos.
- Engage in community discussions.
- Chat with support engineers online.

View services to assist you with your product.

© 2017 Quest Software Inc.

ALL RIGHTS RESERVED.

This guide contains proprietary information protected by copyright. The software described in this guide is furnished under a software license or nondisclosure agreement. This software may be used or copied only in accordance with the terms of the applicable agreement. No part of this guide may be reproduced or transmitted in any form or by any means, electronic or mechanical, including photocopying and recording for any purpose other than the purchaser's personal use without the written permission of Quest Software Inc.

The information in this document is provided in connection with Quest Software products. No license, express or implied, by estoppel or otherwise, to any intellectual property right is granted by this document or in connection with the sale of Quest Software products. EXCEPT AS SET FORTH IN THE TERMS AND CONDITIONS AS SPECIFIED IN THE LICENSE AGREEMENT FOR THIS PRODUCT, QUEST SOFTWARE ASSUMES NO LIABILITY WHATSOEVER AND DISCLAIMS ANY EXPRESS, IMPLIED OR STATUTORY WARRANTY RELATING TO ITS PRODUCTS INCLUDING, BUT NOT LIMITED TO, THE IMPLIED WARRANTY OF MERCHANTABILITY, FITNESS FOR A PARTICULAR PURPOSE, OR NON-INFRINGEMENT. IN NO EVENT SHALL QUEST SOFTWARE BE LIABLE FOR ANY DIRECT, INDIRECT, CONSEQUENTIAL, PUNITIVE, SPECIAL OR INCIDENTAL DAMAGES (INCLUDING, WITHOUT LIMITATION, DAMAGES FOR LOSS OF PROFITS, BUSINESS INTERRUPTION OR LOSS OF INFORMATION) ARISING OUT OF THE USE OR INABILITY TO USE THIS DOCUMENT, EVEN IF QUEST SOFTWARE HAS BEEN ADVISED OF THE POSSIBILITY OF SUCH DAMAGES. Quest Software makes no representations or warranties with respect to the accuracy or completeness of the contents of this document and reserves the right to make changes to specifications and product descriptions at any time without notice. Quest Software does not make any commitment to update the information contained in this document.

If you have any questions regarding your potential use of this material, contact:

Quest Software Inc.
Attn: LEGAL Dept.
4 Polaris Way
Aliso Viejo, CA 92656

Refer to our website (<https://www.quest.com>) for regional and international office information.

Patents

Quest Software is proud of our advanced technology. Patents and pending patents may apply to this product. For the most current information about applicable patents for this product, please visit our website at <https://www.quest.com/legal>.

Trademarks

Quest, the Quest logo, and Join the Innovation are trademarks and registered trademarks of Quest Software Inc. For a complete list of Quest marks, visit <https://www.quest.com/legal/trademark-information.aspx>. All other trademarks and registered trademarks are the property of their respective owners.

Legend

-  **WARNING:** A WARNING icon indicates a potential for property damage, personal injury, or death.

-  **CAUTION:** A CAUTION icon indicates potential damage to hardware or loss of data if instructions are not followed.

-  **IMPORTANT NOTE, NOTE, TIP, MOBILE, or VIDEO:** An information icon indicates supporting information.